

FAX-2440C

MFC-620CN

brother®

If you need to call Customer Service

Please complete the following information for future reference:

Model Number: FAX-2440C and MFC-620CN
(Circle your model number)

Serial Number:* _____

Date of Purchase: _____

Place of Purchase: _____

* The serial number is on the back of the unit. Retain this User's Guide with your sales receipt as a permanent record of your purchase, in the event of theft, fire or warranty service.

Register your product on-line at

<http://www.brother.com/registration>

By registering your product with Brother International Corporation, you will be recorded as the original owner of the product. Your registration with Brother:

- may serve as confirmation of the purchase date of your product should you lose your receipt;
- may support an insurance claim by you in the event of product loss covered by insurance; and,
- will help us notify you of enhancements to your product and special offers.

The most convenient and efficient way to register your new product is on-line at <http://www.brother.com/registration>

Brother numbers

IMPORTANT

For technical help, you must call the country where you bought the machine. Calls must be made **from within** that country.

Register your product

By registering your product with Brother International Corporation, you will be recorded as the original owner of the product. Your registration with Brother:

- may serve as confirmation of the purchase date of your product should you lose your receipt;
- may support an insurance claim by you in the event of product loss covered by insurance; and,
- will help us notify you of enhancements to your product and special offers.

Please complete and fax the Brother Warranty Registration And Test Sheet or, for your convenience and most efficient way to register your new product, register on-line at

<http://www.brother.com/registration>

Frequently asked questions (FAQs)

The Brother Solutions Center is our one-stop resource for all your Fax Machine/Multi-Function Center needs. You can download the latest software and utilities, read FAQs and troubleshooting tips to learn how to get the most from your Brother product.

<http://solutions.brother.com>



You can check here for Brother driver updates.

For Customer Service

In USA: 1-800-284-4329 (voice)
1-901-379-1215 (fax)
1-800-284-3238 (TTY service for the hearing-impaired)

In Canada: 1-877-BROTHER (voice)
(514) 685-4898 (fax)

Service Center Locator (USA only)

For the location of a Brother authorized service center, call 1-800-284-4357.

Service Center Locations (Canada only)

For the location of a Brother authorized service center, call 1-877-BROTHER.

Brother fax back system (USA only)

Brother has installed an easy-to-use fax back system, so you can get instant answers to common technical questions and product information for all Brother products. This system is available 24 hours a day, 7 days a week. You can use the system to receive faxed instructions and an Index of fax back subjects.

In USA only: 1-800-521-2846

Ordering accessories and supplies

For best quality results use only genuine Brother accessories, which are available at most Brother retailers. If you cannot find the accessory you need and you have a Visa, MasterCard, Discover, or American Express credit card, you can order accessories directly from Brother. (In the USA, you can visit us online for a complete selection of the Brother accessories and supplies that are available for purchase.)

In USA: 1-888-879-3232 (voice)
1-800-947-1445 (fax)

<http://www.brothermall.com>

In Canada: 1-877-BROTHER (voice)

| Description | Item |
|--|--|
| Ink Cartridge High Yield <black> (FAX-2440C only) | LC41HYBK (Prints up to 900 pages) |
| Ink Cartridge Standard <black> | LC41BK (Prints up to 500 pages) |
| Ink Cartridge <cyan> (blue) | LC41C (Prints up to 400 pages) |
| Ink Cartridge <magenta> (red) | LC41M (Prints up to 400 pages) |
| Ink Cartridge <yellow> | LC41Y (Prints up to 400 pages) |
| Premium Glossy Photo Paper (Letter size / 20 sheets) | BP60 GLL |
| Matte Inkjet Paper (Letter size / 25 sheets) | BP60 ML |
| Inkjet Plain Paper (Letter size / 250 sheets) | BP60 PL |
| Telephone Line Cord | LG3077001 |
| Telephone Handset | LE0446011 |
| Handset Curled Cord | LE6681001 |
| Power Protector for A/C Power Telephone Line Surges and Voltage Spikes (2 outlets) | QPD120 |
| Power Protector for A/C Power Telephone Line Surges and Voltage Spikes (8 outlets) | FX120 |
| User's Guide | FAX-2440C LF7180001 (English for USA and Canada) LF7181001 (French For Canada) MFC-620CN LF5803001 (English for USA and Canada) LF5906001 (French For Canada) |

Notice - Disclaimer of Warranties (USA and Canada)

BROTHER'S LICENSOR(S), AND THEIR DIRECTORS, OFFICERS, EMPLOYEES OR AGENTS (COLLECTIVELY BROTHER'S LICENSOR) MAKE NO WARRANTIES, EXPRESS OR IMPLIED, INCLUDING WITHOUT LIMITATION THE IMPLIED WARRANTIES OF MERCHANTABILITY AND FITNESS FOR A PARTICULAR PURPOSE, REGARDING THE SOFTWARE. BROTHER'S LICENSOR(S) DOES NOT WARRANT, GUARANTEE OR MAKE ANY REPRESENTATIONS REGARDING THE USE OR THE RESULTS OF THE USE OF THE SOFTWARE IN TERMS OF ITS CORRECTNESS, ACCURACY, RELIABILITY, CURRENTNESS OR OTHERWISE. THE ENTIRE RISK AS TO THE RESULTS AND PERFORMANCE OF THE SOFTWARE IS ASSUMED BY YOU. THE EXCLUSION OF IMPLIED WARRANTIES IS NOT PERMITTED BY SOME STATES IN THE USA AND SOME PROVINCES IN CANADA. THE ABOVE EXCLUSION MAY NOT APPLY TO YOU.

IN NO EVENT WILL BROTHER'S LICENSOR(S) BE LIABLE TO YOU FOR ANY CONSEQUENTIAL, INCIDENTAL OR INDIRECT DAMAGES (INCLUDING DAMAGES FOR LOSS OF BUSINESS PROFITS, BUSINESS INTERRUPTION, LOSS OF BUSINESS INFORMATION, AND THE LIKE) ARISING OUT OF THE USE OR INABILITY TO USE THE SOFTWARE EVEN IF BROTHER'S LICENSOR HAS BEEN ADVISED OF THE POSSIBILITY OF SUCH DAMAGES. BECAUSE SOME STATES IN THE USA AND SOME PROVINCES IN CANADA DO NOT ALLOW THE EXCLUSION OR LIMITATION OF LIABILITY FOR CONSEQUENTIAL OR INCIDENTAL DAMAGES, THE ABOVE LIMITATIONS MAY NOT APPLY TO YOU. IN ANY EVENT BROTHER'S LICENSOR'S LIABILITY TO YOU FOR ACTUAL DAMAGES FROM ANY CAUSE WHATSOEVER, AND REGARDLESS OF THE FORM OF THE ACTION (WHETHER IN CONTRACT, TORT (INCLUDING NEGLIGENCE), PRODUCT LIABILITY OR OTHERWISE), WILL BE LIMITED TO \$50.

Compilation and Publication Notice

Under the supervision of Brother Industries Ltd., this manual has been compiled and published, covering the latest product descriptions and specifications.

The contents of this manual and the specifications of this product are subject to change without notice.

Brother reserves the right to make changes without notice in the specifications and materials contained herein and shall not be responsible for any damages (including consequential) caused by reliance on the materials presented, including but not limited to typographical and other errors relating to the publication.

Brother® One Year Limited Warranty and Replacement Service (USA only)

Who is covered:

- This limited warranty ("warranty") is given only to the original end-use/retail purchaser (referred to in this warranty as "Original Purchaser") of the accompanying product, consumables and accessories (collectively referred to in this warranty as "this Product").
- If you purchased a product from someone other than an authorized Brother reseller in the United States or if the product was used (including but not limited to floor models or refurbished product), prior to your purchase you are not the Original Purchaser and the product that you purchased is not covered by this warranty.

What is covered:

- This Product includes a Machine and Consumable and Accessory Items. Consumable and Accessory Items include but are not limited to print heads, toner, drums, ink cartridges, print cartridges, refill ribbons, therma PLUS paper and thermal paper.
- Except as otherwise provided herein, Brother warrants that the Machine and the accompanying Consumable and Accessory Items will be free from defects in materials and workmanship, when used under normal conditions.
- This warranty applies only to products purchased and used in the United States. For products purchased in, but used outside, the United States, this warranty covers only warranty service within the United States (and does not include shipping outside the United States).

What is the length of the Warranty Periods:

- Machines: one year from the original purchase date.
- Accompanying Consumable and Accessory Items: 90 days from the original purchase date or the rated life of consumable, whichever comes first.

What is NOT covered:

This warranty does not cover:

- (1) Physical damage to this Product;
- (2) Damage caused by improper installation, improper or abnormal use, misuse, neglect or accident (including but not limited to transporting this Product without the proper preparation and/or packaging);
- (3) Damage caused by another device or software used with this Product (including

but not limited to damage resulting from use of non Brother®-brand parts and Consumable and Accessory Items);

- (4) Consumable and Accessory Items that expired in accordance with a rated life; and,
- (5) Problems arising from other than defects in materials or workmanship.
- (6) Normal Periodic Maintenance Items, such as Paper Feeding Kit, Fuser and Laser Units.

This limited warranty is VOID if this Product has been altered or modified in any way (including but not limited to attempted warranty repair without authorization from Brother and/or alteration/removal of the serial number).

What to do if you think your Product is eligible for warranty service:

Report your issue to either our Customer Service Hotline at 1-800-284-4329 for Fax, MFC and DCP and 1-800-276-7746 for Printers, or to a Brother Authorized Service Center **within the applicable warranty period.** Supply Brother or the Brother Authorized Service Center with a copy of your dated bill of sale showing that this Product was purchased within the U.S. For the name of local Brother Authorized Service Center(s), call 1-800-521-2846.

What Brother will ask you to do:

After contacting Brother or a Brother Authorized Service Center, you may be required to deliver (by hand if you prefer) or send the Product properly packaged, freight prepaid, to the Authorized Service Center together with a photocopy of your bill of sale.

You are responsible for the cost of shipping, packing product, and insurance (if you desire). You are also responsible for loss or damage to this Product in shipping.

What Brother will do:

If the problem reported concerning your Machine and/or accompanying Consumable and Accessory Items is covered by this warranty and if you first reported the problem to Brother or an Authorized Service Center within the applicable warranty period, Brother or its Authorized Service Center will repair or replace the Machine and/or accompanying Consumable and Accessory Items at no charge to you for parts or labor. The decision as to whether to repair or replace the Machine and/or accompanying Consumable and Accessory Items is made

Brother® One Year Limited Warranty and Replacement Service (USA only)

by Brother in its sole discretion. Brother reserves the right to supply a refurbished or remanufactured replacement Machine and/or accompanying Consumable and Accessory Items and use refurbished parts provided such replacement products conform to the manufacturer's specifications for new product/parts. The repaired or replacement Machine and/or accompanying Consumable and Accessory Items will be returned to you freight prepaid or made available for you to pick up at a conveniently located Authorized Service Center.

If the Machine and/or accompanying Consumable and Accessory Items are not covered by this warranty (either stage), you will be charged for shipping the Machine and/or accompanying Consumable and Accessory Items back to you and charged for any service and/or replacement parts/products at Brother's then current published rates.

The foregoing are your sole (i.e., only) and exclusive remedies under this warranty.

What happens when Brother elects to replace your Machine:

When a replacement Machine is authorized by Brother, and you have delivered the Machine to an Authorized Service Center, the Authorized Service Center will provide you with a replacement Machine after receiving one from Brother. If you are dealing directly with Brother, Brother will send to you a replacement Machine with the understanding that you will, after receipt of the replacement Machine, supply the required proof of purchase information, together with the Machine that Brother agreed to replace. You are then expected to pack the Machine that Brother agreed to replace in the package from the replacement Machine and return it to Brother using the pre-paid freight bill supplied by Brother in accordance with the instructions provided by Brother. Since you will be in possession of two machines, Brother will require that you provide a valid major credit card number. Brother will issue a hold against the credit card account number that you provide until Brother receives your original Product and determines that your original Product is entitled to warranty coverage. Your credit card will be charged up to the cost of a new Product only if: (i) you do not return your original Product to Brother within five (5) business days; (ii) the problems with your original Product are not covered by the limited warranty; (iii) the proper packaging instructions are not followed and has caused

damage to the product; or (iv) the warranty period on your original Product has expired or has not been sufficiently validated with a copy of the proof of purchase (bill of sale). The replacement Machine you receive (even if refurbished or remanufactured) will be covered by the balance of the limited warranty period remaining on the original Product, plus an additional thirty (30) days. You will keep the replacement Machine that is sent to you and your original Machine shall become the property of Brother. **Retain your original Accessory Items and a copy of the return freight bill, signed by the courier.**

Limitations:

Brother is not responsible for damage to or loss of any equipment, media, programs or data related to the use of this Product. Except for that repair or replacement as described above, Brother shall not be liable for any direct, indirect, incidental or consequential damages or specific relief. Because some states do not allow the exclusion or limitation of consequential or incidental damages, the above limitation may not apply to you.

THIS WARRANTY IS GIVEN IN LIEU OF ALL OTHER WARRANTIES, WRITTEN OR ORAL, WHETHER EXPRESSED BY AFFIRMATION, PROMISE, DESCRIPTION, DRAWING, MODEL OR SAMPLE. ANY AND ALL WARRANTIES OTHER THAN THIS ONE, WHETHER EXPRESS OR IMPLIED, INCLUDING IMPLIED WARRANTIES OF MERCHANTABILITY AND FITNESS FOR A PARTICULAR PURPOSE, ARE HEREBY DISCLAIMED.

- This Limited Warranty is the only warranty that Brother is giving for this Product. It is the final expression and the exclusive and only statement of Brother's obligations to you. It replaces all other agreements and understandings that you may have with Brother or its representatives.
- This warranty gives you certain rights and you may also have other rights that may vary from state to state.
- This Limited Warranty (and Brother's obligation to you) may not be changed in any way unless you and Brother sign the same piece of paper in which we (1) refer to this Product and your bill of sale date, (2) describe the change to this warranty and (3) agree to make that change.

Important: *We recommend that you keep all original packing materials, in the event that you ship this Product.*

BROTHER MULTIFUNCTION CENTER/FACSIMILE MACHINE LIMITED WARRANTY (Canada only)

Pursuant to this limited warranty of 1 year from the date of purchase for labour and parts, Brother International Corporation (Canada) Ltd. ("Brother"), or its Authorized Service Centers, will repair this MFC/Facsimile machine free of charge if defective in material or workmanship. This Limited Warranty does not include cleaning, consumables (including, without limitation, print cartridges, print head, toner and drum) or damage caused by accident, neglect, misuse or improper installation or operation, any damage caused from service, maintenance, modifications, or tampering by anyone other than a Brother Authorized Service Representative, or from the use of supplies or consumable items that are non-Brother products. Operation of the MFC/Facsimile machine in excess of the specifications or with the Serial Number or Rating Label removed shall be deemed abuse and all repairs thereafter shall be the sole liability of the end-user/purchaser. In order to obtain warranty service, the MFC/Facsimile machine must be delivered or shipped freight prepaid by the end user/purchaser to a "Brother" Authorized Service Center, together with your Proof of Purchase in the form of a Sales Receipt.

For laser products: Failure to remove the Toner Cartridge (and Toner Drum Unit on applicable models) during shipping will cause severe damage to the MFC/Facsimile and will VOID the Warranty. (Refer to your User's Guide for proper packaging.)

For ink-jet products: Do not remove the ink cartridges during shipping. Damage to your print head resulting from packing without the ink cartridges will VOID your warranty. (Refer to your User's Guide for proper packaging.)

BROTHER DISCLAIMS ALL OTHER WARRANTIES EXPRESSED OR IMPLIED INCLUDING, WITHOUT LIMITATION, ANY IMPLIED WARRANTIES OF MERCHANTABILITY OR FITNESS FOR A PARTICULAR PURPOSE, EXCEPT TO THE EXTENT THAT ANY WARRANTIES IMPLIED BY LAW CANNOT BE VALIDLY WAIVED.

No oral or written information, advice or representation provided by Brother, its Authorized Service Centers, Distributors, Dealers, Agents or employees, shall create another warranty or modify this warranty. This warranty states Brother's entire liability and your exclusive remedy against Brother for any failure of the MFC/Facsimile machine to operate properly.

Neither Brother nor anyone else involved in the development, production, or delivery of this MFC/Facsimile machine shall be liable for any indirect, incidental, special, consequential, exemplary, or punitive damages, including lost profits, arising from the use of or inability to use the product, even if advised by the end user/purchaser of the possibility of such damages. Since some Provinces do not allow the above limitation of liability, such limitation may not apply to you.

This Limited Warranty gives you specific legal rights and you may also have other rights which vary from Providence to Providence.

Warranty Service is available at Brother Authorized Service Centers throughout Canada. For Technical Support or for the name and location of your nearest Authorized Service Center call 1-877-BROTHER.

Internet support: support@brother.ca or browse

Brother's Web Site: www.brother.com

Brother International Corporation (Canada) Ltd.

1 Rue Hôtel de Ville

Dollard-Des-Ormeaux, QC H9B 3H6







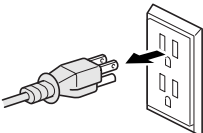

At your side.
brother®

Safety precautions

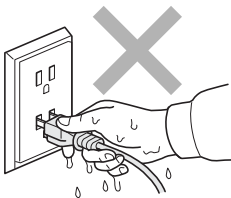
To use the machine safely

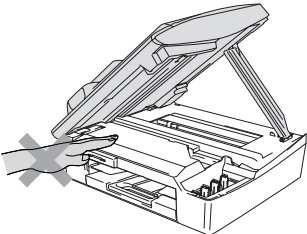
Please refer to these instructions for later reference and before attempting any maintenance.

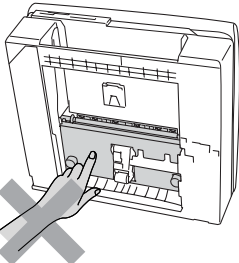
WARNING

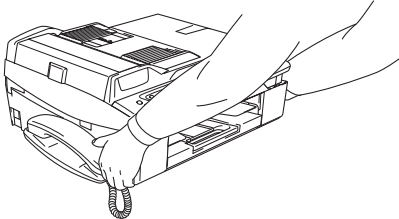
| | | | |
|---|---|---|---|
|  | <p>There are high voltage electrodes inside the machine. Before you clean the machine, make sure you have unplugged the telephone line cord first and then the power cord from the AC power outlet.</p>  |  | <p>Do not handle the plug with wet hands. Doing this might cause an electrical shock.</p>  |
|  | <p>To prevent injuries, be careful not to put your hands on the edge of the machine under the scanner cover.</p>  |  | <p>To prevent injuries, be careful not to touch the area shaded in the illustration.</p>  |
|  | <p>When moving the machine you must lift it from the base, by placing a hand at each side of the unit as shown in the illustration. Do not carry the machine by holding the scanner cover.</p>  | | |

 **WARNING**

- Use caution when installing or modifying telephone lines. Never touch telephone wires or terminals that are not insulated unless the telephone line has been disconnected at the wall jack. Never install telephone wiring during a lightning storm. Never install a telephone wall jack in a wet location.
- This product must be installed near an AC power outlet that is easily accessible. In case of emergencies, you must disconnect the power cord from the AC power outlet in order to shut off power completely.
- To reduce the risk of shock or fire, use only a No. 26 AWG or larger telecommunication line cord.

 **Caution**

- Lightning and power surges can damage this product! We recommend that you use a quality surge protection device on the AC power line and on the telephone line, or unplug the cords during a lightning storm.

IMPORTANT SAFETY INSTRUCTIONS

When using your telephone equipment, basic safety precautions should always be followed to reduce the risk of fire, electric shock and injury to persons, including the following:

1. Do not use this product near water, for example, near a bath tub, wash bowl, kitchen sink or washing machine, in a wet basement or near a swimming pool.
2. Avoid using this product during an electrical storm. There may be a remote risk of electric shock from lightning.
3. Do not use this product to report a gas leak in the vicinity of the leak.
4. Use only the power cord provided with the machine.

SAVE THESE INSTRUCTIONS

Choosing a location

Place your machine on a flat, stable surface that is free of vibration and shocks, such as a desk. Put the machine near a telephone wall jack and a standard, grounded AC power outlet. Choose a location where the temperature remains between 50°F and 95°F (10°-35°C).

Caution

- Avoid placing your machine in a high-traffic area.
- Avoid placing your machine on the carpet.
- Do not place near heaters, air conditioners, water, chemicals, or refrigerators.
- Do not expose the machine to direct sunlight, excessive heat, moisture, or dust.
- Do not connect your machine to electrical outlets controlled by wall switches or automatic timers.
- Disruption of power can wipe out information in the machine's memory.
- Do not connect your machine to electrical outlets on the same circuit as large appliances or other equipment that might disrupt the power supply.
- Avoid interference sources, such as speakers or the base units of cordless phones.

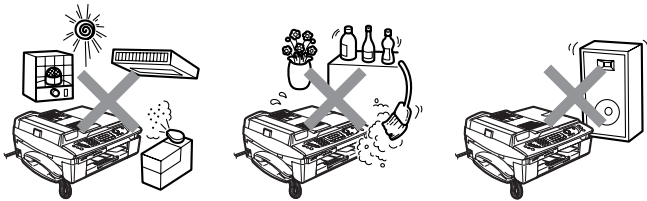

Quick Reference Guide

Sending faxes

Automatic Transmission

- 1 If it is not illuminated in green, press  (**Fax**).
- 2 Load your document.
- 3 Enter the fax number using One-Touch (FAX-2440C only), Speed-Dial, Search or the dial pad.
- 4 Press **Black Start** or **Color Start**.

Storing numbers

Storing One-Touch Dial numbers (FAX-2440C only)

- 1 Press **Menu/Set, 2, 3, 1**.
- 2 Press the One-Touch key where you want to store the number.

 To access One-Touch numbers 4 to 6, hold down **Shift** as you press the One-Touch key.

- 3 Enter a number (up to 20 digits), and then press **Menu/Set**.
- 4 Enter a name up to 15 characters (or leave it blank), and then press **Menu/Set**.
- 5 Press **Stop/Exit**.

Storing Speed-Dial numbers

- 1 For MFC-620CN, press **Menu/Set, 2, 3, 1**.
For FAX-2440C, press **Menu/Set, 2, 3, 2**.
- 2 Using the dial pad, enter a two-digit Speed-Dial location number, and then press **Menu/Set**.
- 3 Enter a number (up to 20 digits), and then press **Menu/Set**.
- 4 Enter a name up to 15 characters (or leave it blank), and then press **Menu/Set**.
- 5 Press **Stop/Exit**.

Dialing operations

One-Touch Dialing (FAX-2440C)/Speed-Dialing

- 1 If it is not illuminated in green, press  (**Fax**).
- 2 Load your document.
- 3 (FAX-2440C only) Press the One-Touch key of the number you want to call.

 To dial One-Touch numbers 4 to 6, hold down **Shift** as you press the One-Touch key.

—OR—

Press **Search/Speed Dial**, press #, and then press the two-digit Speed-Dial number.

- 4 Press **Black Start** or **Color Start**.

Using Search

- 1 If it is not illuminated in green, press  (**Fax**).
- 2 Load your document.
- 3 Press **Search/Speed Dial**, and then enter the first letter of the name you're looking for.
- 4 Press ◀ or ▶ to search the memory.
- 5 Press **Black Start** or **Color Start**.

Making copies

- 1 Press  (**Copy**) to illuminate it in green.
- 2 Load your document.
- 3 Press **Black Start** or **Color Start**.

Table of Contents

1

| | |
|---|------------|
| Introduction | 1-1 |
| Using this Guide | 1-1 |
| Finding information | 1-1 |
| Symbols used in this Guide | 1-1 |
| Control panel overview | 1-2 |
| Turning the machine on and off | 1-5 |
| On/Off Setting | 1-6 |
| Load documents | 1-7 |
| Using the automatic document feeder (ADF) | 1-7 |
| Using the scanner glass | 1-9 |
| About paper | 1-10 |
| Recommended Paper | 1-10 |
| Handling and using special paper | 1-11 |
| Paper type and size for each operation | 1-12 |
| Paper weight, thickness and capacity | 1-13 |
| Paper capacity of the output paper tray | 1-13 |
| Printable area | 1-14 |
| How to load paper, envelopes and post cards | 1-15 |
| To load paper or other media | 1-15 |
| To load envelopes | 1-17 |
| To load post cards | 1-18 |
| About fax machines | 1-19 |
| Custom features | 1-19 |
| Do you have Voice Mail on the phone line? | 1-19 |
| Why should there be problems? | 1-19 |
| How can you avoid possible problems? | 1-19 |
| Fax tones and handshake | 1-20 |
| ECM (Error Correction Mode) | 1-21 |

2

| | |
|---|------------|
| Getting started | 2-1 |
| Initial Setup | 2-1 |
| Setting the Date and Time | 2-1 |
| Setting Tone and Pulse dialing mode | 2-1 |
| Setting the Station ID | 2-2 |
| General Setup | 2-3 |
| Setting the Mode Timer (MFC-620CN only) | 2-3 |
| Setting the Mode Timer (FAX-2440C only) | 2-3 |
| Setting the Paper Type | 2-4 |
| Setting the Paper Size | 2-4 |
| Setting the Ring Volume | 2-5 |
| Setting the Beeper Volume | 2-5 |

| | |
|---|------------|
| Setting the Speaker Volume | 2-6 |
| Setting the Handset Volume | 2-7 |
| Choosing the Handset Volume (For Volume Amplify) | 2-8 |
| Setting Volume Amplify | 2-9 |
| Turning on Automatic Daylight Savings Time | 2-10 |
| Setting the LCD Contrast | 2-10 |
| Setup Send | 3-1 |
| How to enter Fax mode | 3-1 |
| How to dial | 3-1 |
| Manual dialing | 3-1 |
| One-Touch dialing (FAX-2440C only) | 3-2 |
| Speed-Dialing | 3-2 |
| Search | 3-3 |
| Manual and automatic fax Redial | 3-3 |
| How to Fax (B&W and Color) | 3-4 |
| Color fax transmission | 3-4 |
| Faxing from the ADF | 3-4 |
| Faxing from the scanner glass | 3-5 |
| Automatic transmission | 3-6 |
| Manual transmission | 3-6 |
| Sending a fax at the end of a conversation | 3-7 |
| Out of Memory message | 3-7 |
| Basic sending operations | 3-8 |
| Sending faxes using multiple settings | 3-8 |
| Contrast | 3-8 |
| Fax Resolution | 3-9 |
| Dual Access (Not available for color faxes) | 3-10 |
| Real Time Transmission | 3-11 |
| Checking job status | 3-12 |
| Canceling a fax in progress | 3-12 |
| Canceling a scheduled job | 3-12 |
| Advanced sending operations | 3-13 |
| Broadcasting (Not available for color faxes) | 3-13 |
| Overseas Mode | 3-14 |
| Delayed Fax (Not available for color faxes) | 3-15 |
| Setting up Polled Transmit (Not available for color faxes) | 3-15 |
| Delayed Batch Transmission (Not available for color faxes) | 3-16 |
| Faxing A4 size documents from the scanner glass | 3-16 |

4

| | |
|--|------------|
| Setup Receive | 4-1 |
| Basic receiving operations..... | 4-1 |
| Choosing the Receive Mode | 4-1 |
| To select or change your Receive Mode | 4-2 |
| Setting the Ring Delay | 4-3 |
| Setting Toll Saver (Msg Ctr mode) | 4-4 |
| Setting the F/T Ring Time (Fax/Tel mode only)..... | 4-5 |
| Setting the Fax/Tel Announcement | 4-5 |
| Easy Receive | 4-6 |
| Printing a reduced incoming fax (Auto Reduction) | 4-7 |
| Receiving a fax at the end of a conversation..... | 4-7 |
| Printing a fax from the memory | 4-8 |
| Polling | 4-8 |
| Setting up Polling Receive | 4-8 |
| Setting up Sequential Polling Receive | 4-9 |

5

| | |
|--|------------|
| Quick-Dial numbers and dialing options | 5-1 |
| Storing numbers for easy dialing | 5-1 |
| Storing One-Touch Dial numbers (FAX-2440C only).... | 5-1 |
| Storing Speed-Dial numbers | 5-2 |
| Changing One-Touch (FAX-2440C only) and Speed-Dial numbers..... | 5-3 |
| Setting up Groups for Broadcasting (FAX-2440C only)..... | 5-4 |
| Setting up Groups for Broadcasting (MFC-620CN only) | 5-5 |
| Dialing options | 5-7 |
| Access codes and credit card numbers (MFC-620CN only) | 5-7 |
| Access codes and credit card numbers (FAX-2440C only)..... | 5-8 |
| Pause | 5-8 |
| Tone or Pulse | 5-9 |
| Telephone (voice) operations | 5-10 |
| How to dial..... | 5-10 |
| Making a telephone call..... | 5-10 |
| Answering calls with the Speaker Phone | 5-11 |
| Hold | 5-11 |

6

| | |
|---|------------|
| Remote Fax Options (Not available for color faxes) | 6-1 |
| Setting up Fax Forwarding | 6-1 |
| Programming your pager number..... | 6-2 |
| Setting Fax Storage..... | 6-3 |
| Setting PC Fax Receive (MFC-620CN only) | 6-3 |

| | |
|---|-----|
| Turning off Remote Fax Options..... | 6-4 |
| Setting your Remote Access Code..... | 6-5 |
| Remote Retrieval | 6-6 |
| Using your Remote Access Code..... | 6-6 |
| Remote commands..... | 6-7 |
| Retrieving fax messages | 6-9 |
| Changing your Fax Forwarding number | 6-9 |

7

| | |
|--|------------|
| Message Center | 7-1 |
| Message Center mode | 7-1 |
| Setting up the Message Center | 7-1 |
| Recording Message Center Outgoing Message..... | 7-2 |
| Listening to Outgoing Message (OGM) | 7-3 |
| Erasing Outgoing Message (OGM) | 7-3 |
| Activating Message Center mode..... | 7-4 |
| Message indicator..... | 7-4 |
| Playing voice messages | 7-5 |
| Printing a fax message | 7-5 |
| Erasing incoming messages..... | 7-6 |
| To erase voice messages individually | 7-6 |
| To erase messages all at once..... | 7-6 |
| Setting Maximum Time for incoming messages | 7-7 |
| Setting Toll Saver | 7-7 |
| ICM Recording Monitor..... | 7-7 |
| Recording a conversation | 7-8 |
| Record Fax/Tel Outgoing Announcement (F/T OGM) ... | 7-8 |

8

| | |
|---|------------|
| Printing reports | 8-1 |
| Fax settings and activity | 8-1 |
| Customizing the Transmission Verification Report..... | 8-1 |
| Setting the Journal Period | 8-2 |
| Printing reports | 8-3 |
| How to print a report..... | 8-3 |

9

| | |
|---|------------|
| Making copies | 9-1 |
| Using the machine as a copier | 9-1 |
| Enter Copy mode..... | 9-1 |
| Making a single copy | 9-2 |
| Making multiple copies | 9-2 |
| Stop copying..... | 9-2 |
| Using the Copy Options key (Temporary settings) | 9-3 |
| Changing the temporary copy settings | 9-4 |
| Increasing copy speed or quality | 9-5 |
| Enlarging or reducing the image copied..... | 9-6 |

| | |
|---|------|
| Setting paper type | 9-7 |
| Setting paper size..... | 9-8 |
| Adjusting brightness | 9-8 |
| Adjusting contrast..... | 9-9 |
| Sorting copies using the ADF | 9-9 |
| Making N in 1 copies or a poster (Page Layout) | 9-10 |
| Changing the default copy settings | 9-13 |
| Increasing copy speed or quality | 9-13 |
| Adjusting brightness | 9-13 |
| Adjusting contrast..... | 9-13 |
| Adjusting color saturation | 9-14 |
| Out of Memory message | 9-14 |
| Legal limitations..... | 9-15 |

10

| | |
|--|-------------|
| Walk-Up PhotoCapture Center™ (MFC-620CN only) | 10-1 |
| Introduction..... | 10-1 |
| PhotoCapture Center™ requirements | 10-2 |
| Getting started | 10-3 |
| Printing the Index (Thumbnails)..... | 10-5 |
| Printing images..... | 10-6 |
| DPOF printing..... | 10-8 |
| Changing the default settings..... | 10-9 |
| Increasing print speed or quality | 10-9 |
| Setting the paper & size | 10-9 |
| Adjusting brightness | 10-9 |
| Adjusting contrast..... | 10-10 |
| Color enhancement (True2Life®)..... | 10-10 |
| Cropping..... | 10-12 |
| Borderless | 10-12 |
| Understanding the Error Messages..... | 10-13 |
| Using PhotoCapture Center™ from your PC..... | 10-14 |
| Using PhotoCapture Center™ for scanning documents .. | 10-14 |

11

| | |
|--|-------------|
| Important information | 11-1 |
| Standard telephone and FCC Notices | |
| These notices are in effect on models sold and used in the United States only..... | 11-1 |
| Federal Communications Commission (FCC) | |
| Declaration of Conformity (USA only) | 11-3 |
| Important | 11-4 |
| Industry Canada Compliance Statement | |
| (Canada only)..... | 11-4 |
| For your safety..... | 11-4 |
| LAN connection (MFC-620CN only) | 11-4 |

| | |
|--|------|
| International ENERGY STAR® Compliance Statement | 11-5 |
| Important safety instructions | 11-6 |
| Trademarks..... | 11-8 |

12

| | |
|--|-------------|
| Troubleshooting and routine maintenance | 12-1 |
| Troubleshooting | 12-1 |
| Error messages | 12-1 |
| Document jams..... | 12-5 |
| Document is jammed in the top of the ADF unit..... | 12-5 |
| Document is jammed inside the ADF unit. | 12-5 |
| Printer jam or paper jam | 12-6 |
| Paper is jammed inside the paper tray | 12-6 |
| Paper is jammed inside the machine..... | 12-7 |
| If you are having difficulty with your machine | 12-9 |
| Compatibility | 12-13 |
| How to improve print quality | 12-14 |
| Cleaning the print head..... | 12-14 |
| Checking the print quality | 12-15 |
| Checking the printing alignment | 12-17 |
| Checking the ink volume..... | 12-18 |
| Packing and shipping the machine | 12-19 |
| Routine maintenance..... | 12-22 |
| Cleaning the scanner..... | 12-22 |
| Cleaning the machine printer platen | 12-23 |
| Replacing the ink cartridges | 12-24 |

A

| | |
|--|------------|
| Appendix A | A-1 |
| Setting up telephone services..... | A-1 |
| Distinctive Ring..... | A-1 |
| What does your telephone company's | |
| ‘Distinctive Ring’ do? | A-1 |
| What does Brother’s ‘Distinctive Ring’ do?..... | A-2 |
| Do you have Voice Mail? | A-2 |
| Before you choose the ring pattern to register | A-3 |
| Registering the Distinctive Ring pattern..... | A-4 |
| Turning off the Distinctive Ring..... | A-4 |
| Caller ID..... | A-5 |
| Viewing Caller ID List..... | A-6 |
| Printing Caller ID List..... | A-6 |
| Advanced receiving operations..... | A-7 |
| Operation from extension telephones..... | A-7 |
| For Fax/Tel mode when power key is On | A-8 |
| Fax/Tel mode when power key is Off | A-8 |
| Using a cordless external handset..... | A-9 |

| | |
|---|------|
| Changing the remote codes | A-9 |
| Connecting an external device to your machine..... | A-10 |
| Connecting an external telephone..... | A-10 |
| Connecting an external telephone answering device (TAD) | A-11 |
| Sequence | A-11 |
| Connections | A-13 |
| Recording outgoing message (OGM) on an external TAD | A-13 |
| Special line considerations..... | A-14 |
| Roll over phone lines..... | A-14 |
| Two-line phone system | A-14 |
| Converting telephone wall outlets | A-15 |
| Installing machine, external two-line TAD and two-line telephone | A-16 |
| Multi-line connections (PBX) | A-17 |
| If you are installing the machine to work with a PBX..... | A-17 |
| Custom features on your phone line..... | A-17 |

B

| | |
|--------------------------------------|------------|
| Appendix B | B-1 |
| On-screen programming..... | B-1 |
| Menu table..... | B-1 |
| Memory storage..... | B-1 |
| Navigation keys | B-2 |
| Entering Text | B-12 |
| Inserting spaces | B-12 |
| Making corrections | B-12 |
| Repeating letters | B-12 |
| Special characters and symbols | B-13 |

G

| | |
|-----------------------|------------|
| Glossary | G-1 |
|-----------------------|------------|

S

| | |
|--|------------|
| Specifications | S-1 |
| Product description | S-1 |
| General..... | S-1 |
| Print media | S-2 |
| Copy | S-3 |
| PhotoCapture Center™ (MFC-620CN only)..... | S-4 |
| Fax..... | S-5 |
| Scanner (MFC-620CN only) | S-6 |
| Printer | S-7 |
| Interfaces..... | S-8 |
| Computer requirements..... | S-9 |

| | |
|---|------|
| Consumable items | S-10 |
| Network (LAN) (MFC-620CN only) | S-11 |
| Optional External Wireless Print/Scan Server (NC-2200w) (MFC-620CN only) | S-12 |

| | |
|--------------------|------------|
| Index | I-1 |
|--------------------|------------|

| | |
|---|------------|
| Remote Retrieval Access card | R-1 |
|---|------------|

1 Introduction

Using this Guide

Thank you for buying a Brother fax machine or Multi-Function Center (MFC). Your machine is simple to use, with LCD screen instructions to guide you through programming it. You can make the most of your machine by reading through this Guide.





Finding information

All the chapter headings and subheadings are listed in the Table of Contents. You will be able to find information about a specific feature or operation by checking the Index at the back of this Guide.

Symbols used in this Guide

Throughout this Guide you will see special symbols alerting you to important warnings, notes and actions. To make things clearer and to help you press the correct keys, we used special fonts and added some of the messages that will appear in the LCD.

- | | |
|----------------|---|
| Bold | Bold typeface identifies specific keys on the machine control panel. |
| <i>Italics</i> | Italicized typeface emphasizes an important point or refers you to a related topic. |
| Courier New | Courier New type face identifies the messages on the LCD of the machine. |

-  Warnings inform you what to do to avoid possible personal injury.
-  Cautions specify procedures you must follow or avoid to prevent possible damage to the machine.
-  Notes tell you how you should respond to a situation that may arise or give tips about how the current operation works with other features.
-  Improper Setup alerts you to devices and operations that are not compatible with the machine.

Control panel overview

FAX-2440C

MFC-620CN

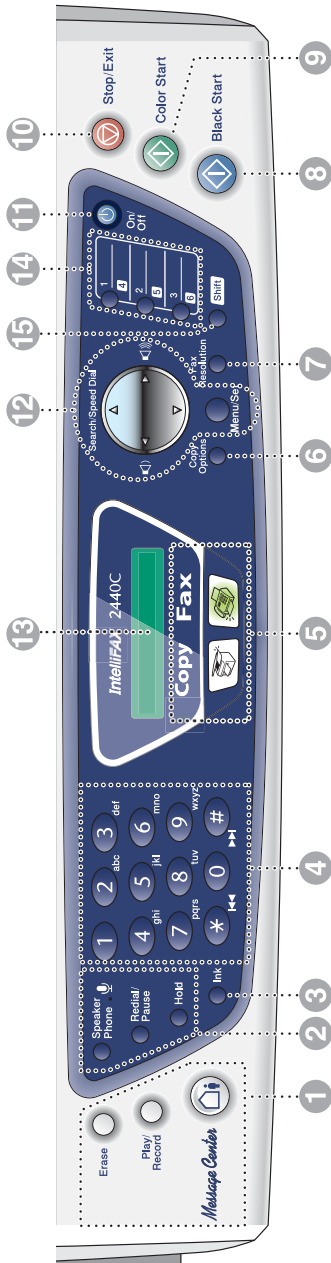

1 Message Center keys



MC On/Off

Lets you activate the Message Center and will blink if you have new messages.

Play/Record

Lets you listen to voice messages stored in memory. Also, lets you record telephone calls.

Erase

Lets you delete voice messages, all fax messages or all messages.

2 Telephone keys



Microphone

Picks up your voice when you speak to another party using Speaker Phone.

Speaker Phone

Lets you speak to another party without lifting the handset.

Redial/Pause

Redials the last number you called. It also inserts a pause in quick dial numbers.

Hold

Lets you place telephone calls on hold.

3 Ink

Lets you clean the print head, check the print quality, and check the available ink volume.

4 Dial Pad

Use these keys to dial telephone and fax numbers and as a keyboard for entering information into the machine.

The # key lets you temporarily switch the dialing mode during a telephone call from Pulse to Tone.

5 Mode keys:



PhotoCapture (MFC-620CN only)

Lets you access the PhotoCapture Center™ mode.



Copy

Lets you access Copy mode.



Fax

Lets you access Fax mode.



Scan (MFC-620CN only)

Lets you access Scan mode.

6 Copy Options

You can quickly and easily select temporary settings for copying.

7 Fax Resolution

Adjusts the resolution when you send a fax.



Black Start

Black Start

Lets you start sending faxes or making copies in black and white.

Also for MFC-620CN, lets you start a scanning operation (in color or mono, depending on the scanning setting on your PC).



Color Start

Color Start

Lets you start sending faxes or making copies in full color.

Also for MFC-620CN, lets you start a scanning operation (in color or mono, depending on the scanning setting on your PC).



Stop/Exit

Stop/Exit

Stops an operation or exits from the menu.

11 On/Off

You can turn the machine on or off.

12 Navigation keys:

Menu/Set

The same key is used for Menu and Set operations.

Lets you access the Menu to program and store your settings in the machine.



In fax mode, you can press these keys to adjust the volume.

▲ Search/Speed Dial

Lets you look up numbers that are stored in the dialing memory. It also lets you dial stored numbers by pressing # and a two-digit number.



Press to scroll backward to a menu selection.



Press to scroll through the menus and options.



Liquid Crystal Display (LCD)

Displays messages on the screen to help you set up and use your machine.

The LCD examples in this User's Guide are for models with a two-line display. There may be slight differences between the examples and models that have a one-line display.



One-Touch keys (FAX-2440C only)

These keys give you instant access to previously stored Quick-Dial numbers.



Shift (FAX-2440C only)

To access One-Touch numbers 4 to 6, hold down **Shift** as you press One-Touch key.

Turning the machine on and off

When the machine is idle, you can turn it on and off by pressing the **On/Off** key. In Off mode, no machine operations will be available. Even if you turned the machine off, it will periodically clean the print head to preserve print quality.

Turning the machine off

Press and hold down the **On/Off** key until the LCD shows:

Shutting Down

The LCD light will go off.

Turning the machine on

Press and hold down the **On/Off** key until the LCD shows:

Please Wait

The LCD will show the date and time (Fax mode).



Even in Off mode, you can receive fax and telephone calls by customizing the **On/Off** key as explained next page.

(See *On/Off Setting* on page 1-6.)



If you have connected an external telephone or TAD, it is always available.

On/Off Setting

You can customize the machine's **On/Off** key. The default setting is `Fax Receive:Off`. Your machine will not work when it is switched Off, but it will purge the ink head periodically. If you turn this setting to `Fax Receive:On`, you can receive faxes or calls even when the machine is switched Off. (See *Turning the machine on and off* on page 1-5.)

- 1 Press **Menu/Set**, **1**, **6**.
- 2 Press **▲** or **▼** to select `On` (or `Off`).
- 3 Press **Menu/Set**.
- 4 Press **Stop/Exit**.

General Setup
6.On/Off Setting

| On/Off Setting | Receive Mode | Available Operations |
|---|-----------------------------|---|
| <code>Fax Receive:Off</code> (default) | — | No machine operations will be available. |
| <code>Fax Receive:On</code> | <code>Fax Only</code> | Fax Receive (automatically), Easy Receive, Delayed Fax*, Remote Fax Options*, Remote Retrieval* ■ You can answer calls by lifting the handset. |
| | <code>MC:Msg Ctr</code> | Fax Receive (automatically), Recording of incoming messages, Fax Detect, Delayed Fax*, Remote Fax Options*, Remote Retrieval* ■ You can answer calls by lifting the handset. |
| | <code>Manual Fax/Tel</code> | Delayed Fax*, Easy Receive ■ You can answer calls by lifting the handset. |

* Should be set before you switch off the machine.



The external telephone is always available.

Load documents

You can send a fax, make copies, and scan from the ADF (automatic document feeder) or from the scanner glass.

Using the automatic document feeder (ADF)

The ADF can hold up to 10 pages and feeds each sheet individually. Use standard (20 lb) paper and always fan the pages before putting them in the ADF.

- ⊘ DO NOT use paper that is curled, wrinkled, folded, ripped, stapled, paper clipped, pasted or taped.
DO NOT use cardboard, newspaper or fabric. (To fax, copy or scan this kind of document, see *Using the scanner glass* on page 1-9.)
- Make sure documents written with ink are completely dry.
- Documents to be faxed must be from 5.8 to 8.5 inches wide and 5.8 to 14 inches long.

- 1 Fan the pages well. Make sure you put the documents **face down, top edge first** in the ADF until you feel them touch the feed roller.
- 2 Adjust the paper guides to fit the width of your documents.
- 3 Unfold the ADF Document Output Support Flap.

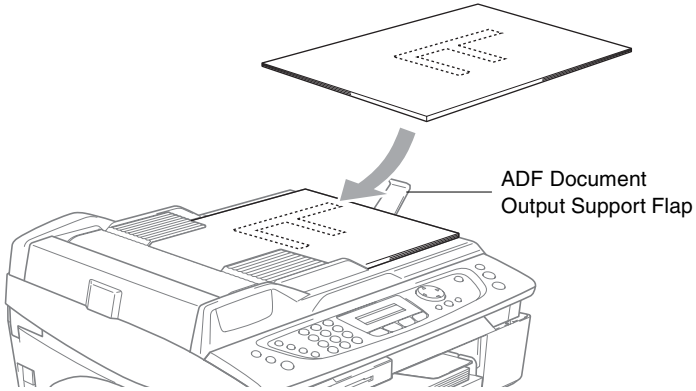

- ! **DO NOT** pull on the document while it is feeding.
- ! To use the ADF, the scanner glass must be empty.

Using the scanner glass

You can use the scanner glass to fax pages of a book or one page at a time. Documents can be up to letter or A4 size (8.5 inches to 11.7 inches).



To use the scanner glass, the ADF must be empty.

- 1** Lift the document cover.



Place documents face down
on the Scanner Glass

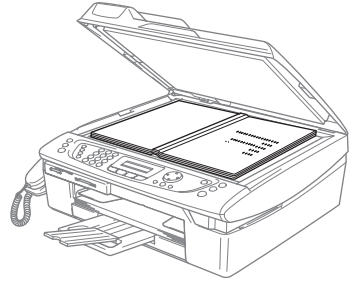
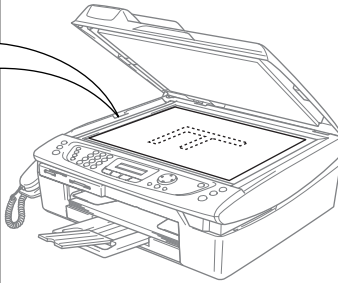

- 2** Using the document guidelines on the left, center the document face down on the scanner glass.
- 3** Close the document cover.



If the document is a book or is thick, do not slam the cover or press on it.

About paper

The print quality can be affected by the type of paper you use in the machine.

To get the best print quality for the settings you've chosen, always set the Paper Type to match the type of paper you load.

You can use plain paper, inkjet paper (coated paper), glossy paper, transparencies and envelopes.

We recommend testing various paper types before purchasing large quantities.

For best results, use the recommended paper.



- When you print on inkjet paper (coated paper), transparencies and glossy paper, be sure to select the proper media in the “Basic” tab of the printer driver or in the Paper Type setting of the menu (**Menu/Set, 1, 2**).
- When you print on Brother glossy paper, load the instruction sheet included with the glossy paper in the paper tray first, and then place the glossy paper on the instruction sheet.
- When you use transparencies or glossy paper, remove each sheet immediately to prevent smudging or paper jams.
- Avoid touching the printed surface of the paper immediately after printing; the surface may not be completely dry and may stain your fingers.

Recommended Paper

To get the best print quality, we suggest using Brother paper. (See table below.)

We recommend using “3M Transparency Film” when you print on transparencies.

Brother Paper

| Paper Type | Item |
|-----------------------------|---------|
| Letter Plain | BP60PL |
| Letter Glossy | BP60GLL |
| Letter Inkjet (Photo Matte) | BP60ML |

Handling and using special paper

- Store paper in its original packaging, and keep it sealed. Keep the paper flat and away from moisture, direct sunlight and heat.
- The coated side of glossy paper is shiny. Avoid touching the shiny (coated) side. Load glossy paper with the shiny side facing down.
- Avoid touching either side of transparencies, because they absorb water and perspiration easily, and this may cause decreased output quality. Transparencies designed for laser printers/copiers may stain your next document. Use only transparencies recommended for inkjet printing.



Do not use paper:

- that are damaged, curled, wrinkled, or irregularly shaped

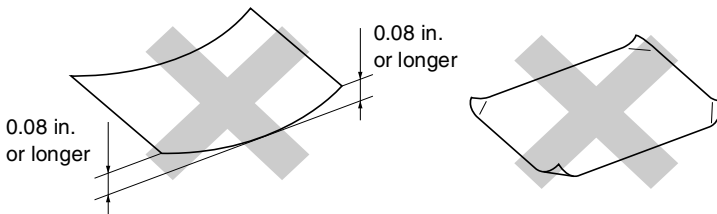

- that are extremely shiny or highly textured
- that were previously printed by a printer
- that cannot be arranged uniformly when stacked
- that are made with a short grain

Paper type and size for each operation

| Paper Type | Paper Size | Usage | | | |
|----------------|-------------------------|-------|------|----------------------------------|---------|
| | | Fax | Copy | PhotoCapture (MFC-620CN only) | Printer |
| Cut Paper | Letter | Yes | Yes | Yes | Yes |
| | A4 | Yes | Yes | Yes | Yes |
| | Legal | Yes | Yes | - | Yes |
| | Executive | - | - | - | Yes |
| | JIS B5 | - | - | - | Yes |
| | A5 | - | Yes | - | Yes |
| A6 | - | - | - | Yes | |
| Cards | Photo | - | Yes | Yes | Yes |
| | Photo L | - | - | - | Yes |
| | Photo 2L | - | - | Yes | Yes |
| | Index Card | - | - | - | Yes |
| | Post Card 1 | - | - | - | Yes |
| | Post Card 2 (Double) | - | - | - | Yes |
| Envelopes | C5 Envelope | - | - | - | Yes |
| | DL Envelope | - | - | - | Yes |
| | COM-10 | - | - | - | Yes |
| | Monarch | - | - | - | Yes |
| | JE4 Envelope | - | - | - | Yes |
| Transparencies | Letter | - | Yes | - | Yes |
| | A4 | - | Yes | - | Yes |

Paper weight, thickness and capacity

| Paper Type | | Weight | Thickness | No. of sheets |
|----------------|--------------|--|---------------------------------------|---------------|
| Cut Paper | Plain Paper | 17 to 32 lb (64 to 120 g/m ²) | 0.003" to 0.006" (0.08 to 0.15 mm) | 100* |
| | Inkjet Paper | 17 to 53 lb (64 to 200 g/m ²) | 0.003" to 0.01" (0.08 to 0.25 mm) | 20 |
| | Glossy Paper | Up to 58 lb (Up to 220 g/m ²) | Up to 0.01" (Up to 0.25 mm) | 20 |
| Cards | Photo Card | Up to 64 lb (Up to 240 g/m ²) | Up to 0.28 mm (Up to 0.01") | 20 |
| | Index Card | Up to 32 lb (Up to 120 g/m ²) | Up to 0.006" (Up to 0.15 mm) | 30 |
| | Post Card | Up to 53 lb (Up to 200 g/m ²) | Up to 0.01" (Up to 0.23 mm) | 30 |
| Envelopes | | 20 to 25 lb (75 to 95 g/m ²) | Up to 0.02" (Up to 0.52 mm) | 10 |
| Transparencies | | - | - | 10 |

* Up to 50 sheets for Legal size paper (20lb)

* Up to 100 sheets of 20lb.

Paper capacity of the output paper tray

| | |
|-------------------|---|
| Output Paper Tray | <p>Up to 25 sheets of 20 lb (Letter)</p> <ul style="list-style-type: none"> ■ Transparencies or glossy paper must be picked up from the output paper tray one page at a time to avoid smudging. ■ Legal paper cannot be stacked on the output paper tray. |
|-------------------|---|

Printable area

The printable area depends on the settings in the application you are using. The figures below show the unprintable areas on cut sheet paper and envelopes.

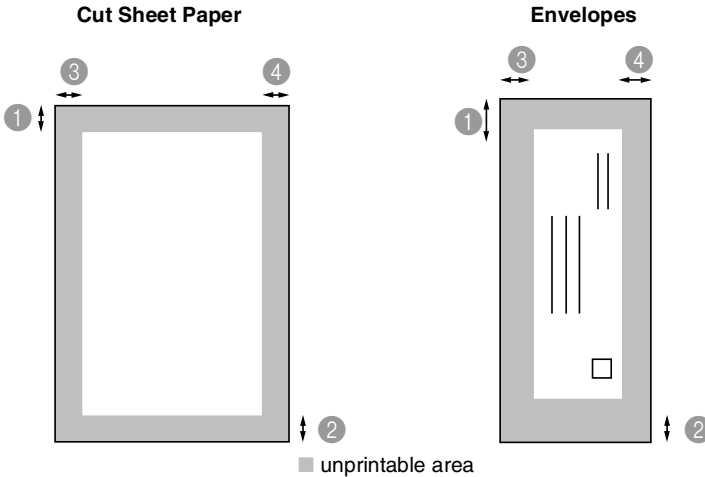

| | ① Top | ② Bottom | ③ Left | ④ Right |
|-----------|-----------------------|-----------------------|-----------------------|-----------------------|
| Cut Sheet | 0.12 in. (0 in.)*1 | 0.12 in. (0 in.)*1 | 0.12 in. (0 in.)*1 | 0.12 in. (0 in.)*1 |
| Envelopes | 0.47 in. | 0.94 in. | 0.12 in. | 0.12 in. |



*1 When you set the Borderless feature to On.

Printable area depends on the Printer driver settings.

The figures above are approximate and the printable area may vary depending on the type of cut sheet paper you are using.

How to load paper, envelopes and post cards

To load paper or other media

- 1 Pull the paper tray completely out of the machine and remove the output paper tray.

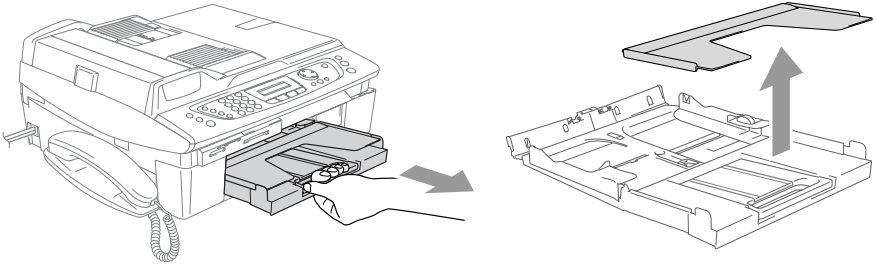

- 2 Press and slide the paper side guide to fit the paper width.

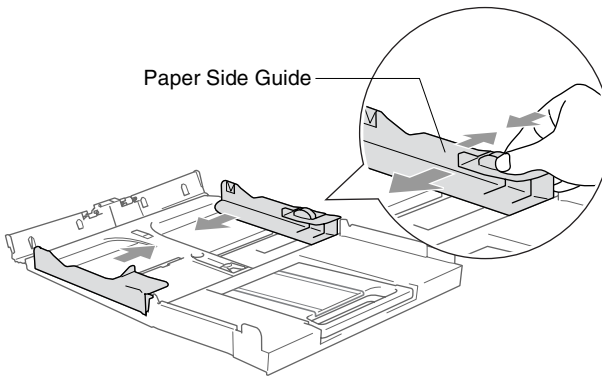

- 3 Pull out the paper support and unfold the paper support flap.

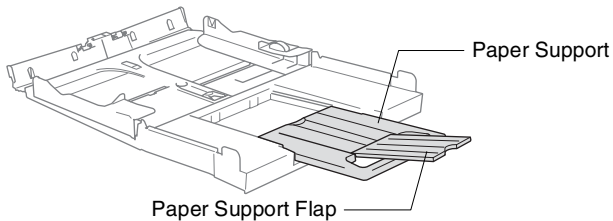

-  Use the paper support flap for Letter, Legal and A4.

- 4** Fan the stack of paper well to avoid paper jams and mis-feeds.

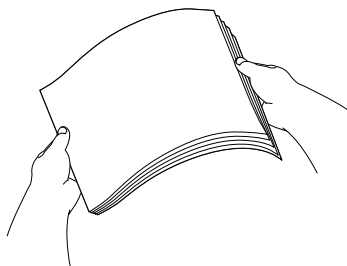

- 5** Gently insert the paper into the paper tray print side down and the leading edge (top of the paper) in first.

Check that the paper is flat in the tray and below the maximum paper mark.

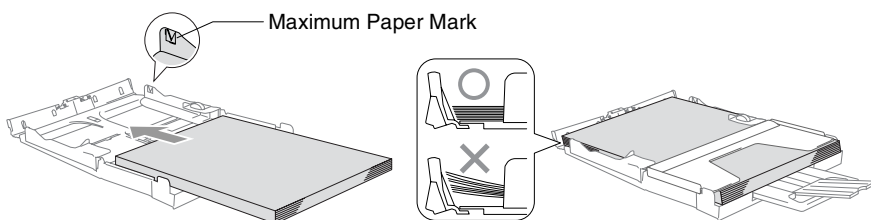

- Make sure the paper side guides touch the sides of the paper.
- Be careful that you do not push the paper in too far; it may lift at the back of the tray and cause feed problems.

- 6** Put the output paper tray back on and push the paper tray firmly back into the machine.

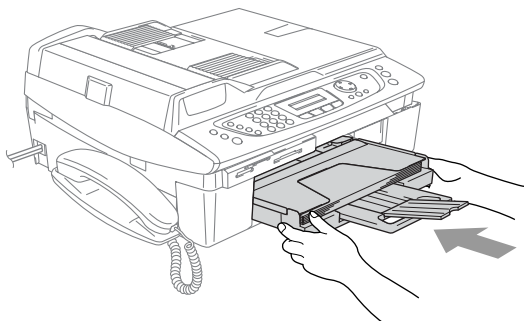

To load envelopes

- Use envelopes that weigh from 75-95 g/m².
- Some envelopes require margin settings in the application. Make sure you do a test print first.
- ⊘ To prevent possible damage to the feeding mechanism, do not use the types of envelopes shown below.

DO NOT USE ENVELOPES:

- that are of a baggy construction
- that are embossed (have raised writing on them)
- that have clasps on them
- that are not sharply creased
- that are preprinted on the inside

■ Glue

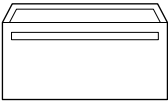

■ Rounded flap

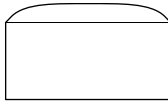

■ Double flap

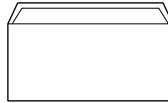

■ Triangular flap

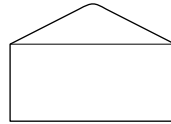

How to load envelopes

- 1 Before loading, press the corners and sides of the envelopes to make them as flat as possible.

-  If the envelopes are 'double-feeding,' put one envelope in the paper tray at a time.

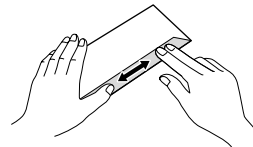
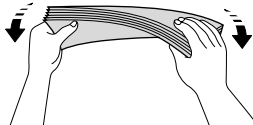
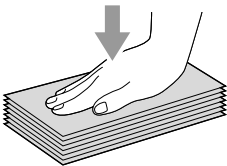

- 2 Insert the envelopes into the paper tray with the address side down and the leading edge (top of the envelopes) in first. Slide the paper side guide to fit the width of the envelopes.

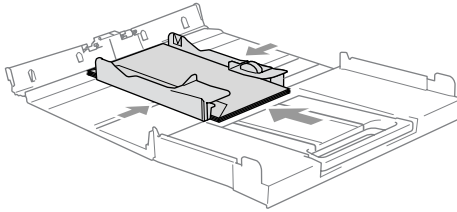

If you have problems when printing on envelopes, try the following suggestions:

- 1 Open the envelope flap.
- 2 Make sure the open flap is either to the side of the envelope or to the back edge of the envelope when printing.
- 3 Adjust the size and margin in your application.

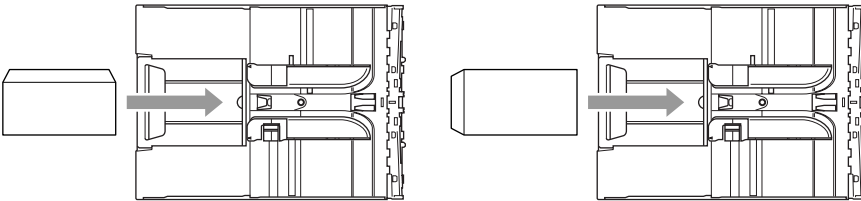

To load post cards

- 1 Raise the paper stop and insert the post cards into the paper tray. Slide the paper side guide to fit the width of the post cards.

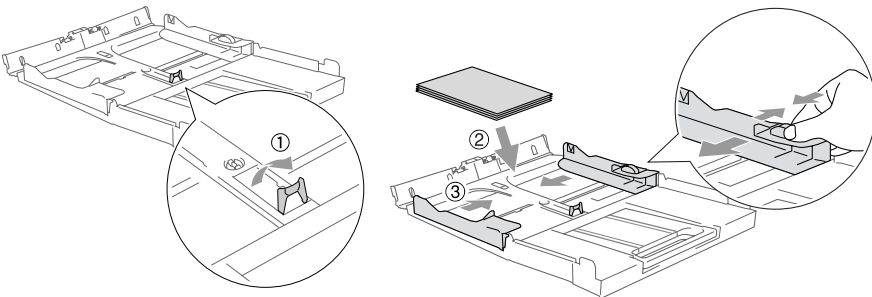

About fax machines

Custom features

Do you have Voice Mail on the phone line?

If you have Voice Mail on the phone line where you will install your new machine, *there is a strong possibility that Voice Mail and the machine may conflict with each other while receiving incoming calls.*

Why should there be problems?

Since both the machine and Voice Mail will pick up the call, after the number of rings you have set, each of them has the ability to keep the other from receiving calls.

For example, if your Voice Mail is set to answer after two rings and your machine is set to answer after four, your Voice Mail will stop your machine from receiving faxes.

If you set Voice Mail and the Brother machine to answer after the same number of rings, there is no way of knowing which one will answer first. It is important to remember that neither Voice Mail nor the machine can pass the call back to the other after the call has been answered.

How can you avoid possible problems?

A very good way to avoid problems like the one mentioned, *is to get a second phone number on your present phone line.*

Many people with Voice Mail choose an alternative service, which is called “Distinctive Ring”, and they are very satisfied with it.

(See *Distinctive Ring* on page A-1.)

Another way to avoid possible problems is to replace your Voice Mail with an answering machine. Your Brother machine is designed to work with an answering machine or TAD (telephone answering device).

(See *Connecting an external telephone answering device (TAD)* on page A-11.)

Fax tones and handshake

When someone is sending a fax, the machine sends fax calling tones (CNG tones). These are quiet, intermittent beeps every 4-seconds. You'll hear them after you dial and press **Black Start** or **Color Start** and they will continue for about 60 seconds after dialing. During that time, the sending machine must begin the "handshake", or connection, with the receiving machine.

Each time you use automatic procedures to send a fax, you are sending CNG tones over the phone line. You will soon learn to listen for these quiet beeps each time you answer a phone on your fax line, so you will know if you are receiving a fax message.

The receiving fax responds with fax receiving tones, which are loud, chirping sounds. A receiving fax chirps for about 40 seconds over the phone line, and the LCD shows *Receiving*.

If your machine is set to the Fax Only mode, it will answer every call automatically with fax receiving tones. If the other person hangs up, your machine will continue to send the "chirps" for about 40 seconds, and the LCD continues to show *Receiving*. To cancel receiving, press **Stop/Exit**.

The fax 'handshake' is the time in which the sending machine's CNG tones and the receiving machine's "chirps" overlap. This must be for at least 2 to 4 seconds, so both machines can understand how each is sending and receiving the fax. The handshake cannot begin until the call is answered, and the CNG tones only last for about 60 seconds after the number is dialed. So it is important for the receiving machine to answer the call in as few rings as possible.



When you have an external Telephone Answering Device (TAD) on your fax line, your TAD will decide the number of rings before the call is answered.

ECM (Error Correction Mode)

The Error Correction Mode (ECM) is a way for the machine to check a fax transmission while it is in progress. If the machine detects errors during fax transmission, it resends the pages of the fax that had an error. ECM transmissions are only possible between fax machines that both have this feature. If they do, you may send and receive fax messages that are continuously being checked by the machine. Your machine must have enough memory for this feature to work.

2 Getting started

Initial Setup

Setting the Date and Time

When the machine is not in use it will display the date and time. If you set up the Station ID the date and time displayed by your machine will be printed on every fax you send. If there is a power failure, you may have to reset the date and time. No other settings will be affected.

- 1 Press **Menu/Set**, **0**, **2**.
- 2 Enter the last two digits of the year.
Press **Menu/Set**.
- 3 Enter two digits for the month.
Press **Menu/Set**.
(For example, enter 09 for September, or 10 for October.)
- 4 Enter two digits for the day.
Press **Menu/Set**. (For example, enter 06 for 6th.)
- 5 Enter the time in 24-Hour format.
Press **Menu/Set**. (For example, enter 15:25 for 3:25 P.M.)
- 6 Press **Stop/Exit**.
The LCD now shows the date and time whenever the machine is in Fax mode.

Initial Setup
2.Date/Time

Setting Tone and Pulse dialing mode

- 1 Press **Menu/Set**, **0**, **4**.
- 2 Press **▲** or **▼** to select `Pulse` (or `Tone`).
Press **Menu/Set**.
- 3 Press **Stop/Exit**.

Initial Setup
4.Tone/Pulse

Setting the Station ID

You should store your name or company name and fax number so they print on all fax pages you send.

1 Press **Menu/Set, 0, 3.**

| |
|-------------------------------|
| Initial Setup 3.Station ID |
|-------------------------------|

2 Enter your fax number
(up to 20 digits).

Press **Menu/Set.**



You cannot enter a hyphen. To enter a space press ► once between numbers.

3 Use the dial pad to enter your name (up to 20 characters).
(See *Entering Text* on page B-12.)

Press **Menu/Set.**

4 Press **Stop/Exit.**



If the Station ID has already been programmed, the LCD will ask you to press **1** to make a change or **2** to exit without changing.

NOTICE (For USA)

The Telephone Consumer Protection Act of 1991 makes it unlawful for any person to use a computer or electronic device to send any message via a telephone fax machine unless such messages clearly contain, in a margin at the top or bottom of each transmitted page, or on the first page of the transmission, the date and time it is sent and an identification of the business or other entity or other individual sending the message and the telephone number of the sending machines or such business, other entity or individual.

To program this information into your machine, see *Setting the Date and Time* on page 2-1 and *Setting the Station ID* on page 2-2.

General Setup

Setting the Mode Timer (MFC-620CN only)

The machine has four temporary mode keys on the control panel: PhotoCapture, Copy, Fax and Scan. You can change the number of seconds or minutes the machine takes after the last Copy, Scan or PhotoCapture operation before it returns to Fax mode. If you select **Off**, the machine stays in the mode you used last.

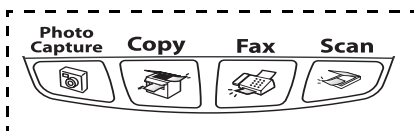

- 1 Press **Menu/Set**, **1**, **1**.
- 2 Press **▲** or **▼** to select
0 Sec, 30 Secs, 1 Min, 2 Mins,
5 Mins or **Off**.
Press **Menu/Set**.
- 3 Press **Stop/Exit**.

General Setup
1.Mode Timer

Setting the Mode Timer (FAX-2440C only)

The machine has two temporary mode keys on the control panel: Fax and Copy. You can change the number of seconds or minutes the machine takes after the last Copy operation before it returns to Fax mode. If you select **Off**, the machine stays in the mode you used last.

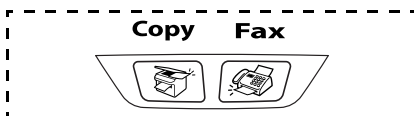

- 1 Press **Menu/Set**, **1**, **1**.
- 2 Press **▲** or **▼** to select
0 Sec, 30 Secs, 1 Min, 2 Mins,
5 Mins or **Off**.
Press **Menu/Set**.
- 3 Press **Stop/Exit**.

General Setup
1.Mode Timer

Setting the Paper Type

To get the best print quality, set the machine for the type of paper you are using.

1 Press **Menu/Set**, **1**, **2**.

2 Press **▲** or **▼** to select

Plain, Inkjet, Glossy or
Transparency.

Press **Menu/Set**.

3 Press **Stop/Exit**.

General Setup
2. Paper Type



The machine ejects paper with printed surfaces face up onto the paper tray in the front of the machine. When you use transparencies or glossy paper, remove each sheet immediately to prevent smudging or paper jams.

Setting the Paper Size

You can use five sizes of paper for printing copies: Letter, Legal, A4, A5, and 4" x 6" and three sizes for printing faxes: Letter, Legal and A4. When you change the type of paper you load in the machine, you will need to change the setting for Paper Size at the same time so your machine can fit an incoming fax on the page.

1 Press **Menu/Set**, **1**, **3**.

2 Press **▲** or **▼** to select

Letter, Legal, A4, A5 or 4" x 6".

Press **Menu/Set**.

3 Press **Stop/Exit**.

General Setup
3. Paper Size

Setting the Ring Volume

You can turn the ring Off or you can select the ring volume level.

1 Press **Menu/Set, 1, 4, 1.**



Volume
1.Ring

2 Press **▲** or **▼** to select
Low, Med, High or Off.

Press **Menu/Set.**

3 Press **Stop/Exit.**

—OR—

You can adjust the ring volume when your machine is idle (not being used). In Fax mode , press  or  to adjust the volume level. Every time you press these keys, the machine will ring so you can hear the active setting as the LCD shows it. The volume changes with each key press. The new setting will stay until you change it again.

Setting the Beeper Volume

You can change the beeper volume. The default (factory) setting is Low. When the beeper is on, the machine will beep when you press a key, make a mistake or after you send or receive a fax.

1 Press **Menu/Set, 1, 4, 2.**

Volume
2.Beeper

2 Press **▲** or **▼** to select your option.
(Low, Med, High or Off)

Press **Menu/Set.**

3 Press **Stop/Exit.**

Setting the Speaker Volume

You can adjust the speaker volume.

1 Press **Menu/Set**, **1**, **4**, **3**.

2 Press **▲** or **▼** to select

Low, Med, High or Off.



Press **Menu/Set**.

3 Press **Stop/Exit**.

| |
|---------------------|
| Volume 3.Speaker |
|---------------------|



—OR—

In Fax mode , you can adjust the speaker volume by pressing **Speaker Phone**, and then selecting a speaker volume level.

Press  or  to adjust the volume level. The LCD shows the setting you are choosing. Each key press changes the volume to the next setting. The new setting will remain until you change it again.



■ You can adjust the speaker volume while you are listening to your OGM (Outgoing Message) and ICMs (Incoming Messages).

■ If you turn Incoming Recording Monitor to OFF (**Menu/Set**, **2**, **7**, **3**) the Speaker for screening calls will be disabled and you won't hear callers leaving messages. The volume for other operations can still be controlled using  or .



Setting the Handset Volume

- 1 Press **Menu/Set, 1, 4, 4.**
- 2 Press ▼ to select **High** or **Low.**
Press **Menu/Set.**
- 3 Press **Stop/Exit.**

| |
|---------------------|
| Volume 4.Handset |
|---------------------|

—OR—



You can adjust the handset volume any time you are talking on the telephone. There are two handset volume levels, **Low** and **High**. The default setting is **Low**.

Press  or  to adjust the volume level. The LCD shows the setting you are choosing. The new setting will remain until you change it again.



Choosing the Handset Volume (For Volume Amplify)

Before you begin to use the machine, you must decide if you need to set the handset volume to `Volume Amplify:On` for a user who is hearing-impaired. The AMPLIFY volume level complies with FCC standards.



`Volume Amplify:Off`

This default setting is appropriate if *none* of the users are hearing-impaired. During a conversation, users can press  or  on the control panel to adjust the volume to `Low` or `High`. When the handset is replaced, the handset volume will remain until you change it again.



`Volume Amplify:On—Temporary`

This setting is appropriate if *some* of the users are hearing-impaired. During a conversation, users can press  or  on the control panel to adjust the volume to `Low`, `High` or `Volume Amplify`. When the handset is replaced, the handset volume returns to the default setting of `Low`.

`Volume Amplify:On—Permanent`

Choose `Volume Amplify:On—Permanent` if *all* of the users are hearing-impaired. During a conversation, users can press  or  on the control panel to adjust the volume to `Low`, `High` or `Volume Amplify`. When the handset is replaced, the handset volume returns to the default setting of `Volume Amplify`.



When you press  or  on the control panel to adjust the volume, the LCD shows the setting you are choosing. Each key press changes the volume to the next setting.



WARNING

It is important that you do NOT choose `Permanent` unless ALL the users are hearing-impaired. Otherwise, the default setting of `Volume Amplify` may damage the hearing of some users.

Setting Volume Amplify

Please carefully read *Choosing the Handset Volume* on page 2-8 before you do the following steps:

1 Press **Menu/Set**, **1**, **4**, **5**.

| |
|----------------------------|
| Volume 5.Volume Amplify |
|----------------------------|

2 If *none* of the users are hearing-impaired, press ▲ or ▼ to select **Off**, and then press **Menu/Set** and go to Step 4.

—OR—

If *some* or *all* of the users are hearing-impaired, select **On**, and then press **Menu/Set**.

3 If all the users are hearing-impaired, press ▲ or ▼ to select **Permanent**, and then press **Menu/Set**.

—OR—

If only *some* of the users are hearing-impaired, select **Temporary**, and then press **Menu/Set**.

4 Press **Stop/Exit**.

Turning on Automatic Daylight Savings Time

You can set the machine to change automatically for Daylight Savings Time. It will reset itself forward one hour in the Spring and backward one hour in the Fall. Make sure you have set the correct day and time in the `Date/Time` setting.

- 1 Press **Menu/Set**, **1**, **5**.
- 2 Press **▲** or **▼** to select `On` (or `Off`).
Press **Menu/Set**.
- 3 Press **Stop/Exit**.

| |
|----------------------------------|
| General Setup 5.Auto Daylight |
|----------------------------------|

Setting the LCD Contrast



You can adjust the LCD contrast for a sharper and more vivid display. If you are having difficulty reading the LCD from your position, try changing the contrast setting for improved viewing.

- 1 Press **Menu/Set**, **1**, **7**.
- 2 Press **▲** or **▼** to select `Light` or `Dark`.
Press **Menu/Set**.
- 3 Press **Stop/Exit**.

| |
|---------------------------------|
| General Setup 7.LCD Contrast |
|---------------------------------|

3 Setup Send

How to enter Fax mode

Before sending faxes, make sure  (**Fax**) is illuminated in green. If not, press  (**Fax**) to enter Fax mode. The default setting is Fax.

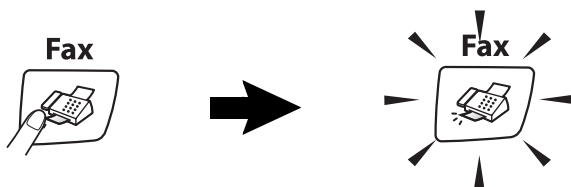

How to dial

You can dial in any of the following different ways.

Manual dialing

Press all of the digits of the phone or fax number.

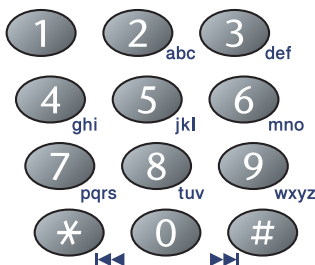

One-Touch dialing (FAX-2440C only)

Press the One-Touch Key of the location you want to call. (See *Storing One-Touch Dial numbers (FAX-2440C only)* on page 5-1.)

To dial One-Touch numbers 4 to 6, hold down **Shift** as you press the One-Touch Key.

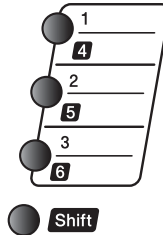

Speed-Dialing

Press **Search/Speed Dial**, **#**, and then the two digit Speed-Dial number. (See *Storing Speed-Dial numbers* on page 5-2.)

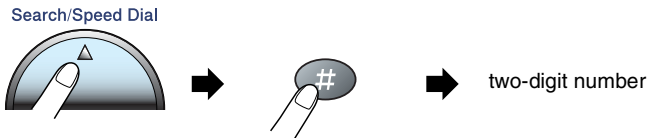

 If the LCD shows **Not Registered** when you enter the Speed-Dial number, a number has not been stored for it.

Search

You can search for names you have stored in the One-Touch (FAX-2440C only) and Speed-Dial memories. Press **Search/Speed Dial** and the navigation keys to search. (See *Storing One-Touch Dial numbers (FAX-2440C only)* on page 5-1 and *Storing Speed-Dial numbers* on page 5-2.)

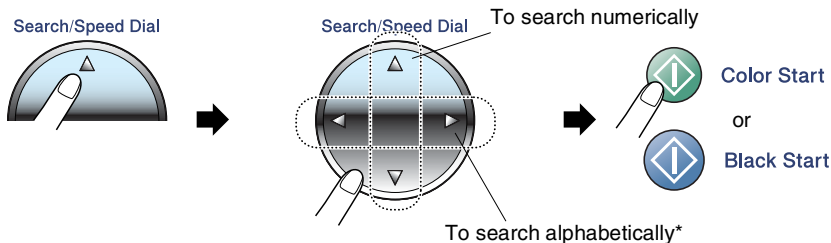

* To search alphabetically, you can use the dial pad to enter the first letter of the name you are looking for.

Manual and automatic fax Redial

If you are sending a fax manually and the line is busy, press **Redial/Pause**, and then press **Black Start** or **Color Start** to try again. If you want to make a second call to the last number dialed, you can save time by pressing **Redial/Pause** and **Black Start** or **Color Start**.

Redial/Pause only works if you dialed from the control panel. *If you are sending a fax automatically* and the line is busy, the machine will automatically redial one time after five minutes.

How to Fax (B&W and Color)

Color fax transmission

Your machine can send a color fax to machines that support this feature.

However, color faxes cannot be stored in the memory. When you send a color fax, the machine will send it in real time (even if **Real Time TX** is set to **Off**).



Delayed fax and Polling Transmit features are not available in color.

Faxing from the ADF

Put the document face down in the ADF. To cancel, press **Stop/Exit**.

- 1** If it is not illuminated in green, press  (**Fax**).
- 2** Load your document.
- 3** Dial the fax number.
- 4** Press **Black Start** or **Color Start**.
 - The machine starts scanning the document.



If the memory is full and you are faxing a single page, it will be sent in real time.

Faxing from the scanner glass

You can use the scanner glass to fax pages of a book or one page at a time. The documents can be up to letter size. To cancel, press **Stop/Exit**.

- 1** If it is not illuminated in green, press  (**Fax**).
- 2** Load your document on the scanner glass.
- 3** Dial the fax number.

Press **Black Start** or **Color Start**.

- If you press **Black Start**, the machine starts scanning the first page.
- If you press **Color Start**, the machine starts sending.

- 4** To send a single page, press **2** (or press **Black Start** again).

Next Page?
1.Yes 2.No(Dial)

The machine starts sending the document.

—OR—

To send more than one page, press **1** and go to Step 5.

- 5** Place the next page on the scanner glass.

Set Next Page
Then Press Set

Press **Menu/Set**.

The machine starts scanning. (Repeat Steps 4 and 5 for each additional page.)



- If the memory is full and you are faxing a single page, it will be sent in real time.
- You cannot send multiple pages for color faxes.

Automatic transmission

This is the easiest way to send a fax.

- ⊘ Do not pick up the handset or press **Speaker Phone** to listen for a dial tone.
- 1 If it is not illuminated in green, press  (**Fax**).
- 2 Load your document.
- 3 Dial the fax number you want to call. (See *How to dial* on page 3-1.)
- 4 Press **Black Start** or **Color Start**.

Manual transmission

Manual transmission lets you hear the dialing, ringing and fax-receiving tones while sending a fax.

- 1 If it is not illuminated in green, press  (**Fax**).
- 2 Load your document.
- 3 Pick up the handset of the machine and listen for a dial tone.
—OR—
Press **Speaker Phone** and listen for a dial tone.
- 4 Dial the fax number you want to call.
- 5 When you hear the fax tone, press **Black Start** or **Color Start**.
- 6 If you picked up the handset replace it.

Sending a fax at the end of a conversation

At the end of a conversation you can send a fax to the other party before you both hang up.

- 1 Ask the other party to wait for fax tones (beeps) and then to press **Start** or **Send** key before hanging up.
- 2 If it is not illuminated in green, press  (**Fax**).
- 3 Load your document.
- 4 Press **Black Start** or **Color Start**.

Out of Memory message

If you get an **Out of Memory** message while scanning the first page of a fax, press **Stop/Exit** to cancel the fax. If you get an **Out of Memory** message while scanning a subsequent page, you will have the option to press **Black Start** to send the pages scanned so far, or to press **Stop/Exit** to cancel the operation.



If the memory is full and you are faxing a single page, it will be sent in real time.

Basic sending operations

Sending faxes using multiple settings

When you send a fax you can choose any combination of these settings: contrast, resolution, overseas mode, delayed fax timer, polling transmission or real time transmission.

- 1 If it is not illuminated in green, press  (**Fax**).

After each setting is accepted, the LCD will ask if you want to enter more settings:

- 2 Press **1** to select more settings. The LCD will return to the Setup Send menu.

Other Settings
1.Yes 2.No

—OR—

Press **2** if you have finished choosing settings and go to the next step.

Contrast

If your document is very light or very dark, you may want to change the contrast.

Use **Light** to send a light document.

Use **Dark** to send a dark document.

- 1 If it is not illuminated in green, press  (**Fax**).

- 2 Load your document.

- 3 Press **Menu/Set**, **2**, **2**, **1**.

- 4 Press **▲** or **▼** to select **Auto**, **Light** or **Dark**.

Setup Send
1.Contrast

Press **Menu/Set**.

Fax Resolution

You can use the **Fax Resolution** key to change the setting temporarily (for this fax only). In Fax mode  , press **Fax Resolution** and ▲ or ▼ to select the setting you want, and then press **Menu/Set**.

—OR—

You can change the default setting:

- 1 If it is not illuminated in green, press  (**Fax**).
- 2 Load your document.
- 3 Press **Menu/Set**, **2**, **2**, **2**.
- 4 Press ▲ or ▼ to select the resolution you want.

| |
|--------------------------------|
| Setup Send 2.Fax Resolution |
|--------------------------------|

Press **Menu/Set**.

| | |
|----------|--|
| Standard | Suitable for most typed documents. |
| Fine | Good for small print and transmits a little slower than Standard resolution. |
| S.Fine | Good for small print or artwork and transmits slower than Fine resolution. |
| Photo | Use when the document has varying shades of gray or is a photograph. This has the slowest transmission time. |

Dual Access (Not available for color faxes)

You can dial a number, and begin scanning the fax into memory—even when the machine is sending from memory or receiving faxes. The LCD shows the new job number and available memory.



Your machine normally uses Dual Access. However, to send a color fax, the machine will send the document in real time (even if `Real Time TX is Off`).

The number of pages you can scan into the memory will vary depending on the data that is printed on them.



If you get an `Out of Memory` message while scanning the first page of a fax, press **Stop/Exit** to cancel scanning. If you get an `Out of Memory` message while scanning a subsequent page, you can press **Black Start** to send the pages scanned so far, or press **Stop/Exit** to cancel the operation.

Real Time Transmission

When you are sending a fax, the machine will scan the documents into the memory before sending. Then, as soon as the phone line is free, the machine will start dialing and sending.

If the memory becomes full, the machine will send the document in real time (even if `Real Time TX` is set to `Off`).

Sometimes, you may want to send an important document immediately, without waiting for memory transmission. You can set `Real Time TX` to `On` for all documents or for the next fax only.

If you want to fax multiple pages from the scanner glass, `Real Time Transmission` should be set to `Off`.

1 If it is not illuminated in green, press  (**Fax**).

2 Load your document.

3 Press **Menu/Set**, **2**, **2**, **5**.

4 To change the default setting, press **▲** or **▼** to select `On` (or `Off`).

Setup Send
5.Real Time TX

Press **Menu/Set**.

—OR—

For the next fax transmission only, press **▲** or **▼** to select `Next Fax Only`.

Press **Menu/Set** and go to Step 5.

5 For the next fax only, press **▲** or **▼** to select `On` (or `Off`).

Press **Menu/Set**.

 In Real Time Transmission, the redial feature does not work.

 If you are sending a color Fax, the machine will send it in real time (even if `Real Time TX` is set to `Off`).

Checking job status

Check which jobs are still waiting in the memory to be sent. (If there are no jobs, the LCD shows `No Jobs Waiting`.)

- 1 Press **Menu/Set**, **2**, **6**.
- 2 If you have more than one job waiting, press **▲** or **▼** to scroll through the list.
- 3 Press **Stop/Exit**.

| |
|-------------------------|
| Fax 6.Remaining Jobs |
|-------------------------|

Canceling a fax in progress

If you want to cancel a fax, while the machine is scanning, dialing or sending it, press **Stop/Exit**.

Canceling a scheduled job

You can cancel a fax job that is stored and waiting in the memory.

- 1 Press **Menu/Set**, **2**, **6**.
Any jobs that are waiting will appear on the LCD.
- 2 If you have more than one job waiting, press **▲** or **▼** to select the job you want to cancel.
Press **Menu/Set**.
—OR—
If you only have one job waiting, go to Step 3.
- 3 Press **1** to cancel.
To cancel another job go to Step 2.
—OR—
Press **2** to exit without canceling.
- 4 Press **Stop/Exit**.

| |
|-------------------------|
| Fax 6.Remaining Jobs |
|-------------------------|

Advanced sending operations

Broadcasting (Not available for color faxes)

Broadcasting is when the same fax message is automatically sent to more than one fax number. You can include Groups, One-Touch (FAX-2440C only), Speed-Dial numbers and up to 50 manually dialed numbers in the same broadcast.

Press **Menu/Set** between each of the numbers. Use **Search/Speed Dial** to help you choose the numbers easily. (To set up Group dial numbers, see *Setting up Groups for Broadcasting (MFC-620CN only)* on page 5-5.)

After the broadcast is finished, a Broadcast Report will be printed to let you know the results.

- 1** If it is not illuminated in green, press  (**Fax**).
- 2** Load your document.
- 3** Enter a number using One-Touch (FAX-2440C only), Speed-Dial, a Group number, Search or manual dialing using the dial pad.
(Example: Group number)
- 4** When the LCD displays the fax number or name of the other party, press **Menu/Set**.
You will be asked to enter the next number.
- 5** Enter the next number.
(Example: Speed-Dial number)
- 6** When the LCD displays the fax number or name of the other party, press **Menu/Set**.
- 7** After you have entered all the fax numbers by repeating Step 5 and 6, go to Step 8 to start the broadcast.
- 8** Press **Black Start**.



- If you did not use up any of the numbers for Groups, access codes or credit card numbers, you can 'broadcast' faxes to as many as 136 (FAX-2440C) or 130 (MFC-620CN) different numbers.
- The available memory will vary depending on the types of jobs in the memory and the number of locations used for broadcasting. If you broadcast to the maximum numbers available, you will not be able to use Dual Access and Delayed fax.
- Enter the long dialing sequence numbers as you would normally, but remember that each One-Touch (FAX-2440C only) and Speed-Dial number counts as one number, so the number of locations you can store becomes limited.
- If the memory is full, press **Stop/Exit** to stop the job or if more than one page has been scanned, press **Black Start** to send the portion that is in the memory.

Overseas Mode

If you are having difficulty sending a fax overseas due to possible interference on the phone line, we recommend that you turn on the Overseas Mode. After you send a fax using this feature, the feature will turn itself off.

1 If it is not illuminated in green, press  (**Fax**).

2 Load your document.

3 Press **Menu/Set**, **2**, **2**, **7**.

4 Press **▲** or **▼** to select **On** (or **Off**).

Press **Menu/Set**.

| |
|-------------------------------|
| Setup Send 7.Overseas Mode |
|-------------------------------|

Delayed Fax (Not available for color faxes)

During the day you can store up to 50 faxes in the memory to be sent within 24 hours. These faxes will be sent at the time of day you enter in Step 4.

1 If it is not illuminated in green, press  **(Fax)**.

2 Load your document.

3 Press **Menu/Set, 2, 2, 3**.

4 Press **Menu/Set** to accept the displayed time.

Setup Send
3.Delayed Fax

—OR—

Enter the time you want the fax to be sent (in 24-hour format).

Press **Menu/Set**.

(For example, enter 19:45 for 7:45 PM.)



The number of pages you can scan into the memory depends on the amount of data that is printed on each page.

Setting up Polled Transmit (Not available for color faxes)

Polled Transmit is when you set up your machine to wait with a document so another fax machine can call and retrieve it.

1 If it is not illuminated in green, press  **(Fax)**.

2 Load your document.

3 Press **Menu/Set, 2, 2, 6**.

4 Press **▲** or **▼** to choose **On** (or **Off**).

Setup Send
6.Polled TX

Press **Menu/Set**.



The document will be stored in the machine's memory and can be retrieved from any other fax machine until you delete the fax in memory by using the Canceling a Job menu setting.

(See *Canceling a scheduled job* on page 3-12.)

Delayed Batch Transmission (Not available for color faxes)

Before sending the delayed faxes, your machine will help you economize by sorting all the faxes in the memory by destination and scheduled time. All delayed faxes that are scheduled to be sent at the same time to the same fax number will be sent as one fax to save transmission time.

1 If it is not illuminated in green, press  **(Fax)**.

2 Press **Menu/Set, 2, 2, 4**.

3 Press **▲** or **▼** to select **On** (or **Off**).

Setup Send
4.Batch TX

Press **Menu/Set**.

4 Press **Stop/Exit**.



The document will be stored in the machine's memory and can be retrieved from any other fax machine until you delete the fax from memory by using the Canceling a job menu setting.

(See *Canceling a scheduled job* on page 3-12.)

Faxing A4 size documents from the scanner glass

When documents are A4 size, you need to set Scan Glass Size to A4; if you do not, the bottom portion of the faxes will be missing.

1 Press **Menu/Set, 2, 2, 0**.

2 Press **▲** or **▼** to select **A4** (or **Letter**).

Press **Menu/Set**.

3 Press **Stop/Exit**.

4 Setup Receive

Basic receiving operations

Choosing the Receive Mode

There are four different Receive Modes for your machine. You can choose the mode that best suits your needs. (See *Message Center mode* on page 7-1 to set up the MC:Msg Ctr mode.)

| LCD | How it works | When to use it |
|---|---|--|
| Fax Only (automatic receive) | The machine automatically answers every call as a fax. | For dedicated fax lines. |
| Fax/Tel (fax and telephone) | The machine controls the line and automatically answers every call. If the call is a fax it will receive the fax. If the call is not a fax it will ring (pseudo/double ring) for you to pick up the call. | Use this mode if you expect to receive lots of fax messages and few telephone calls. You cannot have an answering machine on the same line, even if it is on a separate wall jack on the same line. You cannot use the telephone company's Voice Mail in this mode. |
| Manual (manual receive) (with Distinctive Ring) | You control the phone line and must answer every call yourself. | Use this mode if you do not receive many fax messages, have an external TAD connected to the machine, use Distinctive Ring, or if you are using a computer modem on the same phone line. If you answer and hear fax tones, wait until the machine takes over the call, then hang up. (See <i>Easy Receive</i> on page 4-6.) —OR— Make sure Easy Receive is set to On. (See <i>Easy Receive</i> on page 4-6.) |
| MC:Msg Ctr  ON | The built-in digital Message Center answers voice calls and automatically receives faxes. | Use this mode to record voice messages in the machine's memory. (For details, see <i>Message Center mode</i> on page 7-1.) |

To select or change your Receive Mode

- 1 If it is not illuminated in green, press  (**Fax**).
- 2 Press **Menu/Set, 0, 1**.
- 3 Press **▲** or **▼** to select **Fax Only**,
Fax/Tel, or **Manual**.
Press **Menu/Set**.
- 4 Press **Stop/Exit**.

Initial Setup
1.Receive Mode

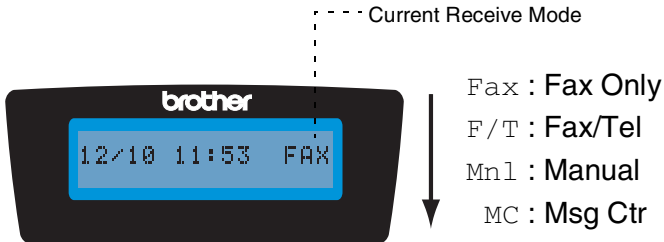

Press and hold until it
lights.

If the Message Center Mode is On, it
overrides your Receive Mode setting.
The screen shows **MC:Msg Ctr**



OFF

If the Message Center Mode is Off, the
Receive Mode returns to your own
setting. (See *Message Center* on
page 7-1.)

Setting the Ring Delay

The Ring Delay sets the number of times the machine rings before it answers in *Fax Only*, *Fax/Tel* and *MC:Msg Ctr* modes. If you have extension phones on the same line as the machine or subscribe to the telephone company's Distinctive Ring service, keep the Ring Delay setting of 4.

(See *Easy Receive* on page 4-6 and *Operation from extension telephones* on page A-7.)

1 If it is not illuminated in green, press  (**Fax**).

2 Press **Menu/Set**, **2**, **1**, **1**.

3 Press **▲** or **▼** to select Ring Delay.

Setup Receive
Ring Delay

Press **Menu/Set**.

4 Press **▲** or **▼** to select how many times the line rings before the machine answers (00-04).

Press **Menu/Set**.

(If you select 00, the line won't ring at all.)

5 Press **Stop/Exit**.



Toll Saver must be **Off** to use the Ring Delay setting.
(See *Setting Toll Saver (Msg Ctr mode)* on page 4-4.)

Setting Toll Saver (Msg Ctr mode)

When you set the toll saver feature, the machine answers after four rings if you do not have voice or fax messages and after two rings if you do have voice or fax messages. This way, when you call the machine for remote retrieval and let it ring three times, you know you have no messages and can hang up to avoid a toll charge.



- When Toll Saver is **On**, it overrides your Ring Delay setting. (See *Setting the Ring Delay* on page 4-3.)
- The Toll Saver feature is available only when the Message Center is set to **On**.
- If you are using Distinctive Ring, do **NOT** use the Toll Saver feature.

1 If it is not illuminated in green, press  (**Fax**).

2 Press **Menu/Set, 2, 1, 1**.

3 Press **▲** or **▼** to select **Toll Saver**.
Press **Menu/Set**.

Setup Receive
Toll Saver

4 Press **▲** or **▼** to select **On** (or **Off**).
Press **Menu/Set**.

5 Press **Stop/Exit**.

Setting the F/T Ring Time (Fax/Tel mode only)

If you set the Receive Mode to Fax/Tel, you'll need to decide how long the machine will signal you with its special pseudo/double-ring when you have a *voice* call. (If it's a fax call, the machine prints the fax.)

This pseudo/double-ring happens after the initial ringing from the phone company. Only the machine rings and no other phones on the same line will ring with the special pseudo/double-ring. However, you can still answer the call on any telephone. (See *For Fax/Tel mode when power key is On* on page A-8.)

1 If it is not illuminated in green, press  **(Fax)**.

2 Press **Menu/Set, 2, 1, 2**.

3 Press **▲** or **▼** to select how long the machine will ring to alert you that you have a voice call (20, 30, 40 or 70 seconds).



Setup Receive
2.F/T Ring Time

Press **Menu/Set**.

4 Press **Stop/Exit**.

 Even if the caller hangs up during the pseudo/double-ringing, the machine will continue to ring for the set time.

Setting the Fax/Tel Announcement

For the Fax/Tel receive mode, you can set up the machine to play an outgoing announcement for callers when no one is there to answer calls. (See *Record Fax/Tel Outgoing Announcement (F/T OGM)* on page 7-8.)

Easy Receive

When you use this feature, you don't have to press **Black Start**, **Color Start**, or the Fax Receive Code *51 when you answer a fax call and hear calling beeps. Just hold the handset and wait a few seconds. Selecting **On** allows the machine to receive fax calls automatically, even if you lift the machine's handset or the handset of an extension or external phone. When you see **Receiving** on the LCD or when you hear "chirps" through the handset of an extension phone connected to another wall jack, just replace the handset and your machine will do the rest. **Semi** lets the machine receive the fax only if you've answered it at the machine.



- If you've set the feature to **On**, but your machine does not automatically connect a fax call when you lift an external or extension phone handset, press the Fax Receive code *51. At the machine, press **Black Start** or **Color Start**.
- If you send faxes from a computer on the same phone line and the machine intercepts them, set Easy Receive to **Off**.
- Selecting **Off** means you'll have to activate the machine yourself by pressing **Black Start** or **Color Start** on the machine.

—OR—

Press *51 on the external or extension phone if you are not at your machine. (See *Operation from extension telephones* on page A-7.)

1 If it is not illuminated in green, press  (**Fax**).

2 Press **Menu/Set, 2, 1, 3**.

3 Use **▲** or **▼** to select **On** (**Semi** or **Off**).

Setup Receive
3.Easy Receive

Press **Menu/Set**.

4 Press **Stop/Exit**.

Printing a reduced incoming fax (Auto Reduction)

If you choose **On**, the machine automatically reduces an incoming fax to fit on one page of Letter, Legal or A4 size paper. The machine calculates the reduction ratio by using the page size of the document and your Paper Size setting (**Menu/Set, 1, 3**).

1 If it is not illuminated in green, press  (**Fax**).

2 Press **Menu/Set, 2, 1, 5**.

3 Use **▲** or **▼** to select **On** (or **Off**).

Setup Receive
5.Auto Reduction

Press **Menu/Set**.

4 Press **Stop/Exit**.



■ Turn on this setting if you receive faxes that are split onto two pages. However, if the document is too long the machine may still print it on two pages.

■ If left and right margins are cut off, turn on this setting.

Receiving a fax at the end of a conversation

At the end of a conversation you can ask the other party to fax you information before you both hang up.

1 Ask the other party to place the document in their machine and to press **Start** or **Send** key.

2 When you hear the other machine's CNG tones (beeps), press **Black Start** or **Color Start**.

3 If you picked up the handset, replace it.

Printing a fax from the memory

If you have selected Fax Forwarding, Paging or Fax Storage (**Menu/Set, 2, 5, 1**), you can still print a fax from the memory when you are at your machine. (See *Setting Fax Storage* on page 6-3.)

- 1** Press **Menu/Set, 2, 5, 3**.
- 2** Press **Black Start**.

Remote Fax Opt
3.Print Fax

Polling

Polling is the process of retrieving faxes from another fax machine. You can use your machine to 'poll' other machines, or you can have someone poll your machine.

Everyone who is involved in Polling needs to set up their fax machines for Polling. When someone polls your machine to receive a fax, they pay for the call. If you poll someone's fax machine to receive a fax, you pay for the call.



Some fax machines do not respond to the Polling feature.

Setting up Polling Receive

Polling Receive is when you call another fax machine to receive a fax from it.

- 1** If it is not illuminated in green, press  (**Fax**).
- 2** Press **Menu/Set, 2, 1, 6**.
- 3** Enter the fax number you are polling.
- 4** Press **Black Start** or **Color Start**.

Setup Receive
6.Polling RX

The LCD shows *Dialing*.

Setting up Sequential Polling Receive

Your machine can ask for faxes from several fax units in a single operation (Sequential Polling Receive). Afterwards, a Sequential Polling Report will be printed.

- 1 If it is not illuminated in green, press  (**Fax**).
- 2 Press **Menu/Set, 2, 1, 6**.
- 3 Enter the fax machines you want to poll using One-Touch (FAX-2440C only), Speed-Dial, a Group or the dial pad. You must press **Menu/Set** between each fax number.
- 4 Press **Black Start** or **Color Start**. Your machine will poll each number or Group number in turn to receive a fax.

Setup Receive
6.Polling RX

5 Quick-Dial numbers and dialing options

Storing numbers for easy dialing

You can set up your machine to do following types of easy dialing: One-Touch (FAX-2440C only), Speed-Dial and Groups for Broadcasting faxes. When you dial a quick-dial number, the LCD shows the name, if you stored it, or the number.

 *If you lose electrical power, the quick-dial numbers that are in the memory will not be lost.*

Storing One-Touch Dial numbers (FAX-2440C only)

Your machine has 3 One-Touch keys where you can store 6 fax or phone numbers for automatic dialing. To access numbers **4** to **6**, hold down **Shift** as you press the One-Touch key. (See *One-Touch dialing (FAX-2440C only)* on page 3-2.)

One-Touch keys are located on the right side of the control panel.

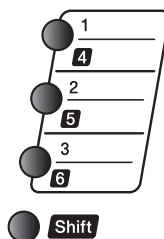

- 1 Press **Menu/Set**, **2**, **3**, **1**.
- 2 Press the One-Touch key where you want to store a number.
- 3 Enter the number (up to 20 digits).

Press **Menu/Set**.

- If you want to enter a pause in the dialing sequence (for example, to access an outside line), press **Redial/Pause** as you are entering the digits.

Each key press of **Redial/Pause** enters a 3.5 second pause when the number is dialed, displayed by a dash on the screen.



Set Quick-Dial
1.One-Touch Dial

- 4** Use the dial pad to enter the name (up to 15 characters).
Press **Menu/Set**.
(You can use the chart on page B-12 to help you enter letters.)
—OR—
Press **Menu/Set** to store the number without a name.
- 5** Go to Step 2 to store another One-Touch number.
—OR—
Press **Stop/Exit**.

Storing Speed-Dial numbers

You can store Speed-Dial numbers, so that when you dial you will only have to press a few keys (**Search/Speed Dial**, **#**, the two-digit number, and **Black Start** or **Color Start**). The machine can store 80 Speed-Dial numbers.

- 1** For MFC-620CN, press **Menu/Set, 2, 3, 1**.
For FAX-2440C, press **Menu/Set, 2, 3, 2**.
- 2** Use the dial pad to enter a two-digit Speed-Dial location number (01-80).
(For example, press **05**.)
Press **Menu/Set**.
- 3** Enter the phone or fax number (up to 20 digits).
Press **Menu/Set**.
- 4** Use the dial pad to enter the name (up to 15 characters).
Press **Menu/Set**.
(You can use the chart on page B-12 to help you enter letters.)
—OR—
Press **Menu/Set** to store the number without a name.
- 5** Go to Step 2 to store another Speed-Dial number.
—OR—
Press **Stop/Exit**.

Changing One-Touch (FAX-2440C only) and Speed-Dial numbers

If you try to store a One-Touch (FAX-2440C only) or Speed-Dial number where a number has already been stored, the LCD will show the name that has been stored there (or number) and will ask you to do one of the following:

- 1 Press **1** to change the stored number.

| |
|----------------------------|
| 05:Mike 1.Change 2.Exit |
|----------------------------|

—OR—

Press **2** to exit without making a change.

How to change the stored number or name:

- If you want to change a character, use ◀ or ▶ to position the cursor under the character you want to change, and then type over it.
- If you want to erase the whole number or whole name, press **Stop/Exit** when the cursor is under the first digit or letter. The characters above and to the right of the cursor will be deleted.

- 2 Enter a new number.

Press **Menu/Set**.

- 3 Follow the directions beginning at Step 4 in Storing One-Touch Dial numbers and Storing Speed-Dial numbers. (See page 5-1 and 5-2.)

Setting up Groups for Broadcasting (FAX-2440C only)

Groups, which can be stored on a One-Touch key or a Speed-Dial location, allow you to send the same fax message to many fax numbers by pressing only a One-Touch key and **Black Start** or **Search/Speed Dial**, #, the two-digit location and **Black Start**.

First, you will need to store each fax number as a One-Touch or Speed-Dial number. Then, you can combine them into a Group, *Each Group uses up a One-Touch key or a Speed-Dial location*. Finally, you can have up to six small Groups, or you can assign up to 85 numbers to one large Group.

(See *Storing Speed-Dial numbers* on page 5-2 and *Changing One-Touch (FAX-2440C only) and Speed-Dial numbers* on page 5-3.)

- 1 Press **Menu/Set**, **2**, **3**, **3**.
- 2 Decide where you wish to store the Group.

Set Quick-Dial
3.Setup Groups

—AND—

Press a One-Touch key.

—OR—

Press **Search/Speed Dial** and enter the two-digit location, and then press **Menu/Set**.

- 3 Use the dial pad to enter the Group number (1 to 6).

Press **Menu/Set**.

(For example, press **1** for Group 1.)

- 4 To include One-Touch or Speed-Dial numbers in the Group, enter them as follows.

For example, for One-Touch number **2**, press One-Touch key **2**. For a number in a black square, such as One-Touch key **6**, press **Shift** and One-Touch key **6**.

For Speed-Dial location 09, press **Search/Speed Dial**, and then press **09** on the dial pad. The LCD shows * 02, #09 (or * 06, #09).

- 5 Press **Menu/Set** to accept the numbers for this Group.
 - 6 Use the dial pad and the chart on page B-12 to enter a name for the Group.
Press **Menu/Set**.
(For example, NEW CLIENTS)
 - 7 Press **Stop/Exit**.
-  You can print a list of all One-Touch and Speed-Dial numbers. (See *Printing reports* on page 8-3.) Group numbers will be marked in the GROUP column.

Setting up Groups for Broadcasting (MFC-620CN only)

Groups allow you to send the same fax message to many fax numbers by pressing only a few keys (**Search/Speed Dial**, #, the two-digit number, and **Black Start**). First, you'll need to store each fax number as a Speed-Dial number. Then, you can combine them into a Group. Each Group uses up a Speed-Dial number. You can have up to six Groups, or you can assign up to 79 numbers to one large Group.

(See *Storing Speed-Dial numbers* on page 5-2 and *Broadcasting (Not available for color faxes)* on page 3-13.)

- 1 Press **Menu/Set**, **2**, **3**, **2**.
- 2 Use the dial pad to enter the two-digit Speed-Dial number where you want to store the Group.
Press **Menu/Set**.
(For example, press **07** and **Menu/Set**.)

Set Quick-Dial
2.Setup Groups

Setup Groups
Speed-Dial? #

- 3** Use the dial pad to enter the Group number (1 to 6).

```
Setup Groups
Setup Group:G01
```

Press **Menu/Set**.

(For example, press **1** for Group 1.)



The Group number must be between 1 and 6.

- 4** To include Speed-Dial numbers in the Group, press them as follows:

```
Setup Groups
G01:#05#09
```

For example, for Speed-Dial numbers 05 and 09. Press **Search/Speed Dial, 05, Search/Speed Dial, 09**. The LCD shows: #05#09.

- 5** Press **Menu/Set** to accept the Speed-Dial numbers for this Group.

- 6** Use the dial pad and the chart on page B-12 to enter a name for the Group.

Press **Menu/Set**.

(For example, type NEW CLIENTS).

- 7** Press **Stop/Exit**.



You can print a list of all the Speed-Dial numbers. Group numbers will be marked in the GROUP column.

(See *Printing reports* on page 8-3.)

Dialing options



There are following ways to dial. (See *How to dial* on page 3-1.)

Access codes and credit card numbers (MFC-620CN only)

Sometimes you may want to choose from several long distance carriers when you make a call. Rates may vary depending on the time and destination. To take advantage of low rates, you can store the access codes or long-distance carriers and credit card numbers as Speed-Dial numbers. You can store these long dialing sequences by dividing them and setting them up as separate Speed-Dial numbers in any combination. You can even include manual dialing using the dial pad. (See *Storing Speed-Dial numbers* on page 5-2.)

For example, perhaps you have stored '555' on Speed-Dial #03 and '7000' on Speed-Dial #02. If you press **Search/Speed Dial, #03, Search/Speed Dial, #02, and Black Start or Color Start**, you will dial '555-7000'.

To temporarily change a number, you can substitute part of the number with manual dialing using the dial pad.

For example, to change the number to 555-7001 you could press **Search/Speed Dial, #03** and then press **7001** using the dialing pad.



If you must wait for another dial tone or signal at any point in the dialing sequence, store a pause in the number by pressing **Redial/Pause**. Each key press adds a 3.5-second delay.

Access codes and credit card numbers (FAX-2440C only)

Sometimes you may want to choose from several long distance carriers when you make a call. Rates may vary depending on the time and destination. To take advantage of low rates, you can store the access codes or long-distance carriers and credit card numbers as One-Touch and Speed-Dial numbers. You can store these long dialing sequences by dividing them and setting them up as separate One-Touch and Speed-Dial numbers in any combination. You can even include manual dialing using the dial pad. (See *Storing One-Touch Dial numbers (FAX-2440C only)* on page 5-1 and *Storing Speed-Dial numbers* on page 5-2.)

For example, perhaps you have stored '555' on One-Touch key **1** and '7000' on One-Touch key **2**. If you press One-Touch key **1**, One-Touch key **2**, and **Black Start** or **Color Start**, you will dial '555-7000'.

To temporarily change a number, you can substitute part of the number with manual dialing using the dial pad.

For example, to change the number to 555-7001 you could press One-Touch key **1** and then press **7001** using the dialing pad.



If you must wait for another dial tone or signal at any point in the dialing sequence, store a pause there in the number by pressing **Redial/Pause**. Each key press adds a 3.5-second delay.

Pause

Press **Redial/Pause** to insert a 3.5-second pause between numbers. If you are dialing overseas, you can press **Redial/Pause** as many times as needed to increase the length of the pause.

Tone or Pulse

If you have a Pulse dialing service, but need to send Tone signals (for example, for telephone banking), follow the instructions below. If you have Touch Tone service, you will not need this feature to send tone signals.

- 1** Lift the handset.
- 2** Press # on the machine's control panel. Any digits dialed after this will send tone signals.

When you hang up, the machine will return to the Pulse dialing service.

Telephone (voice) operations

You can use the machine to make voice telephone calls by dialing manually or by using Search, One-Touch Dial (FAX-2440C only) or Speed-Dial memory. You can use the handset or **Speaker Phone** to make and receive calls.

When you dial a Quick-Dial number, the LCD shows the name you've stored, or if you haven't stored a name, the fax number you've stored.

How to dial

See *How to dial* on page 3-1.

Making a telephone call

- 1 Pick up the handset.
—OR—
Press **Speaker Phone**.
- 2 When you hear a dial tone, dial the number using the dial pad, One-Touch (FAX-2440C only), Speed-Dial and Search.
- 3 If you pressed **Speaker Phone**, speak clearly toward the microphone .
- 4 To hang up, replace the handset.
—OR—
Press **Speaker Phone**.

Answering calls with the Speaker Phone

When the machine rings, instead of lifting the handset, press **Speaker Phone**. Speak clearly, toward the microphone . To end the call, press **Speaker Phone**.

If you have a bad telephone line connection, the other party might hear your voice echoed during the call. Hang up and try the call again—**OR**—Pick up the handset.

Hold

- 1** Press **Hold** to put a call on Hold.
- 2** You can replace the handset without disconnecting the call.
- 3** Pick up the machine handset to release the call from Hold. Picking up an extension handset will not release the call from Hold.

6

Remote Fax Options (Not available for color faxes)



You can only use one remote fax option at a time:
Fax Forwarding—OR—Paging—OR—Fax Storage—OR—
PC FAX Receive—OR—Off.

You can change your selection at any time (**Menu/Set, 2, 5, 1**).
(See *Turning off Remote Fax Options* on page 6-4.)

Setting up Fax Forwarding

When you select Fax Forward, your machine stores the received fax in the memory. The machine will then dial the fax number you've programmed and forward the fax message.

1 Press **Menu/Set, 2, 5, 1**.

Remote Fax Opt
1.Fwd/Page/Store

2 Press **▲** or **▼** to select
Fax Forward.

Press **Menu/Set**.

The LCD will ask you to enter the fax number to which faxes will be forwarded.

3 Enter the forwarding number (up to 20 digits).

Press **Menu/Set**.

4 Press **▲** or **▼** to select **On** or **Off**.

Fax Forward
Backup Print:On

Press **Menu/Set**.



If you select **Backup Print:On**, the machine will also print the fax at your machine so you will have a copy if there is a power failure before it is forwarded.

5 Press **Stop/Exit**.

Programming your pager number

When Paging is selected, your machine dials the pager number you've programmed, and then dials your Personal Identification Number (PIN). This activates your pager so you will know that you have a voice or fax message in the memory.

1 Press **Menu/Set, 2, 5, 1**.

| |
|------------------------------------|
| Remote Fax Opt 1.Fwd/Page/Store |
|------------------------------------|

2 Press **▲** or **▼** to select **Paging**.

3 Enter your pager phone number followed by **# #** (up to 20 digits). Press **Menu/Set**.

Do not include the area code if it is the same as that of your machine.

For example, press **1 8 0 0 5 5 5 1 2 3 4 # #**.

4 If your pager needs a PIN, enter the PIN, press **#**, press **Redial/Pause**, enter your fax number followed by **# #**.

Press **Menu/Set**.

(For example, press **1 2 3 4 5 # Redial/Pause 1 8 0 0 5 5 5 1 2 1 2 # #**)

—OR—

If you do not need a PIN, press **Redial/Pause**, enter your fax number followed by **# #**.

Press **Menu/Set**.

(For example, press **Redial/Pause 1 8 0 0 5 5 5 3 4 3 4 # #**)

5 Press **Stop/Exit**.



- You cannot change a Paging number or PIN remotely. If you have set Paging, a backup copy of the received fax will automatically be printed at the machine.
- If you want to be paged for voice messages make sure you pressed the **MC On/Off** key to turn the Message Center on.

Setting Fax Storage

If you select Fax Storage, your machine stores the received fax in the memory. You will be able to retrieve fax messages from another location using the Remote Retrieval commands.

1 Press **Menu/Set, 2, 5, 1**.

Remote Fax Opt
1.Fwd/Page/Store

2 Press **▲** or **▼** to select
Fax Storage.

Press **Menu/Set**.

3 Press **Stop/Exit**.



If you have set Fax Storage, a backup copy of the received fax will automatically be printed at the machine.

Setting PC Fax Receive (MFC-620CN only)

If you select PC Fax Receive, your machine will temporarily store your received fax messages in its memory, and then automatically send the faxes to the PC. You can then use your PC to view and store these faxes.

1 Press **Menu/Set, 2, 5, 1**.

Remote Fax Opt
1.Fwd/Page/Store

2 Press **▲** or **▼** to select
PC Fax Receive.

Press **Menu/Set**.

3 Press **▲** or **▼** to select On or Off.

PC Fax Receive
Backup Print:On

Press **Menu/Set**.

4 Press **Stop/Exit**.



- Before you can set up PC Fax Receive you must install the MFL-Pro Suite software on your PC. Make sure your PC is connected and turned on. (For details see *Using Brother PC-FAX software* on page 5-1 in Software User's Guide on the CD-ROM.)
- If you select `Backup Print: On`, the machine will also print the fax at your machine so you will have a copy if there is a power failure before it is sent to the PC.
- If you get an error message and the machine cannot print the faxes in memory, you can use this setting to transfer your faxes to your PC. (For details, see *Error messages* on page 12-1.)

Turning off Remote Fax Options

If you set the Remote Fax Options to `Off` and there are faxes in your machine's memory, the LCD will give you two options.

- If you press **1**, all unprinted faxes will be printed and erased before the setting turns off. If a backup copy has already been printed it will not be printed again.
- If you press **2**, the memory will not be erased and the setting will be unchanged.

(See *Printing a fax from the memory* on page 4-8.)

Setting your Remote Access Code

The remote access code lets you access the Remote Retrieval features when you are away from your machine. Before you use the remote access and retrieval features, you have to set up your own code. The default code is inactive code (--- *).

1 Press **Menu/Set, 2, 5, 2**.

| |
|-----------------------------------|
| Remote Fax Opt 2.Remote Access |
|-----------------------------------|

2 Enter a three-digit code using numbers **0-9** or *.

Press **Menu/Set**. (The preset ‘*’ cannot be changed.)

 Do not use the same code which is set in your Fax Receive Code (***51**) or Telephone Answer Code (**#51**).
(See *Operation from extension telephones* on page A-7.)

3 Press **Stop/Exit**.

 You can change your code at any time by entering a new one. If you want to make your code inactive, press **Stop/Exit** in Step 2 to restore the inactive setting (--- *).

Remote Retrieval

You can call your machine from any touch tone telephone or fax machine, then use the Remote Access Code and remote commands to retrieve fax messages. Be sure to cut out the Remote Retrieval Access Card on the last page and keep it with you at all times.

Using your Remote Access Code

- 1** Dial your fax number from a telephone or another fax machine using touch tone.
 - 2** When your machine answers, immediately enter your Remote Access Code (3 digits followed by *).
 - 3** The machine signals if it has received messages:
 - 1 long beep — Fax messages**
 - 2 long beeps — Voice messages**
 - 3 long beeps — Fax & Voice messages**
 - No beeps — No messages**
 - 4** The machine gives two short beeps to tell you to enter a command. The machine will hang up if you wait longer than 30 seconds to enter a command. The machine will beep three times, if you enter an invalid command.
 - 5** Press **90** to reset the machine when you've finished.
 - 6** Hang up.
-  If your machine is set to **Manual** mode and you want to use the remote retrieval features, you can access your machine by waiting about 2 minutes after it starts ringing, and then entering the Remote Access Code within 30 seconds.

Remote commands

Follow the commands below to access features when you are away from the machine. When you call the machine and enter your Remote Access Code (3 digits followed by *), the system will give two short beeps and you must enter a remote command.

| Remote commands | | Operation details | |
|---|---------------------------------|---|--|
| 91 Playing Voice Messages | | After one long beep, the machine plays the ICM. | |
| | 1 Repeat or Skip Backward | Press 1 while listening to an ICM to repeat it. If you press 1 before a message, you will hear the previous message. | |
| | 2 Skip Forward | While playing the ICM, you can skip to the next message. | |
| | 9 STOP Playing | Stop playing the ICM. | |
| 93 Erase all ICM | | If you hear one long beep, the erase is accepted. If you hear three short beeps, you cannot erase because all voice messages have not been played, or there are no voice message to erase. *This code erases all recorded messages, not one at a time. | |
| 94 Play and Record OGM in Memory | | | |
| | 1 Play | 1 Msg Ctr OGM | The machine plays the selected OGM. You can stop playing OGMs by pressing 9 . |
| | | 2 F/T OGM | |
| | 2 Record | 1 Msg Ctr OGM | After one long beep, you can record the selected OGM. You will hear the message played once. You can stop recording the message by pressing 9 . |
| 2 F/T OGM | | | |

| Remote commands | Operation details | | | | | | | | |
|--|---|---|-------------------------------|---|----------|-------------------------|---------------|--|--|
| 95 Change the Fax Forwarding, Paging or Fax Storage settings <table border="1" data-bbox="204 244 527 683"> <tr> <td data-bbox="204 244 527 316">1 OFF</td> <td data-bbox="527 244 1024 316">You can select <code>off</code> after you have retrieved or erased all your messages.</td> </tr> <tr> <td data-bbox="204 316 527 355">2 Fax Forwarding</td> <td data-bbox="527 316 1024 355" rowspan="5">If you hear one long beep, the change has been accepted. If you hear three short beeps, you cannot change it because something has not been set up (for example, perhaps a Fax Forwarding or paging number had not been registered). You can register your Fax Forwarding number by entering 4. (See <i>Changing your Fax Forwarding number</i> on page 6-9.) Once you have registered the number, Fax Forwarding will work. You can select <code>off</code> after you have retrieved or erased all your messages.</td> </tr> <tr> <td data-bbox="204 355 527 395">3 Paging</td> </tr> <tr> <td data-bbox="204 395 527 435">4 Fax Forwarding number</td> </tr> <tr> <td data-bbox="204 435 527 475">6 Fax Storage</td> </tr> <tr> <td data-bbox="204 475 527 683"></td> </tr> </table> | 1 OFF | You can select <code>off</code> after you have retrieved or erased all your messages. | 2 Fax Forwarding | If you hear one long beep, the change has been accepted. If you hear three short beeps, you cannot change it because something has not been set up (for example, perhaps a Fax Forwarding or paging number had not been registered). You can register your Fax Forwarding number by entering 4. (See <i>Changing your Fax Forwarding number</i> on page 6-9.) Once you have registered the number, Fax Forwarding will work. You can select <code>off</code> after you have retrieved or erased all your messages. | 3 Paging | 4 Fax Forwarding number | 6 Fax Storage | | |
| 1 OFF | You can select <code>off</code> after you have retrieved or erased all your messages. | | | | | | | | |
| 2 Fax Forwarding | If you hear one long beep, the change has been accepted. If you hear three short beeps, you cannot change it because something has not been set up (for example, perhaps a Fax Forwarding or paging number had not been registered). You can register your Fax Forwarding number by entering 4. (See <i>Changing your Fax Forwarding number</i> on page 6-9.) Once you have registered the number, Fax Forwarding will work. You can select <code>off</code> after you have retrieved or erased all your messages. | | | | | | | | |
| 3 Paging | | | | | | | | | |
| 4 Fax Forwarding number | | | | | | | | | |
| 6 Fax Storage | | | | | | | | | |
| | | | | | | | | | |
| 96 Retrieve a fax <table border="1" data-bbox="204 722 527 895"> <tr> <td data-bbox="204 722 527 826">2 Retrieve all faxes</td> <td data-bbox="527 722 1024 826">Enter the number of a remote fax machine to receive stored fax message(s). (See page 6-9.)</td> </tr> <tr> <td data-bbox="204 826 527 895">3 Erase faxes from the memory</td> <td data-bbox="527 826 1024 895">If you hear one long beep, fax messages have been erased from the memory.</td> </tr> </table> | 2 Retrieve all faxes | Enter the number of a remote fax machine to receive stored fax message(s). (See page 6-9.) | 3 Erase faxes from the memory | If you hear one long beep, fax messages have been erased from the memory. | | | | | |
| 2 Retrieve all faxes | Enter the number of a remote fax machine to receive stored fax message(s). (See page 6-9.) | | | | | | | | |
| 3 Erase faxes from the memory | If you hear one long beep, fax messages have been erased from the memory. | | | | | | | | |
| 97 Check the receiving status <table border="1" data-bbox="204 930 527 1023"> <tr> <td data-bbox="204 930 527 978">1 Fax</td> <td data-bbox="527 895 1024 1023" rowspan="2">You can check whether your machine has received any fax or voice messages. If yes, you will hear one long beep. If no, you will hear three short beeps.</td> </tr> <tr> <td data-bbox="204 978 527 1023">2 Voice</td> </tr> </table> | 1 Fax | You can check whether your machine has received any fax or voice messages. If yes, you will hear one long beep. If no, you will hear three short beeps. | 2 Voice | | | | | | |
| 1 Fax | You can check whether your machine has received any fax or voice messages. If yes, you will hear one long beep. If no, you will hear three short beeps. | | | | | | | | |
| 2 Voice | | | | | | | | | |
| 98 Change the Receive Mode <table border="1" data-bbox="204 1058 527 1182"> <tr> <td data-bbox="204 1058 527 1106">1 Msg Ctr</td> <td data-bbox="527 1023 1024 1182" rowspan="3">If you hear one long beep, your change has been accepted.</td> </tr> <tr> <td data-bbox="204 1106 527 1153">2 Fax/Tel</td> </tr> <tr> <td data-bbox="204 1153 527 1182">3 Fax Only</td> </tr> </table> | 1 Msg Ctr | If you hear one long beep, your change has been accepted. | 2 Fax/Tel | 3 Fax Only | | | | | |
| 1 Msg Ctr | If you hear one long beep, your change has been accepted. | | | | | | | | |
| 2 Fax/Tel | | | | | | | | | |
| 3 Fax Only | | | | | | | | | |
| 90 Exit | Pressing 90 will allow you to exit Remote Retrieval. Wait for the long beep, then replace the handset. | | | | | | | | |

Retrieving fax messages

- 1 Dial your fax number.
 - 2 When your machine answers, immediately enter your Remote Access Code (3 digits followed by *). If you hear one long beep, you have messages.
 - 3 As soon as you hear two short beeps, use the dial pad to press **962**.
 - 4 Wait for the long beep, and then use the dial pad to enter the number of the remote fax machine where you want your fax messages sent to followed by ## (up to 20 digits).
-  You cannot use * and # as dial numbers. However, press # if you want to store a pause.
- 5 Hang up after you hear your machine beep. Your machine will call the other machine, which will then print your fax messages.

Changing your Fax Forwarding number

You can change the default setting of your fax forwarding number from another telephone or fax machine using touch tone.

- 1 Dial your fax number.
 - 2 When your machine answers, immediately enter your Remote Access Code (3 digits followed by *). If you hear one long beep, you have messages.
 - 3 When you hear two short beeps, use the dial pad to press **954**.
 - 4 Wait for the long beep, and then use the dial pad to enter the new number of the remote fax machine where you want your fax messages forwarded followed by ## (up to 20 digits).
-  You cannot use * and # as dial numbers. However, press # if you want to store a pause.
- 5 Hang up after you hear your machine beep.

7 Message Center

Message Center mode

Message Center mode allows you to store up to 99 incoming voice messages that are a maximum of 3 minutes each in the memory. Voice messages are stored on a “first-come, first-served” basis. You can retrieve voice messages remotely. (See *Remote Retrieval* on page 6-6.)

You must record an outgoing message in order to use the Message Center mode. (See *Recording Message Center Outgoing Message* on page 7-2.)

Setting up the Message Center

You must set up the Message Center in the following order:

- 1** Record Message Center Outgoing Message (Msg Ctr OGM). (See *Recording Message Center Outgoing Message* on page 7-2.)
- 2** Press and hold  until it lights to activate the Message Center mode. (See *Activating Message Center mode* on page 7-4 and *Message indicator* on page 7-4.)

Recording Message Center Outgoing Message

Recording the Message Center Outgoing Message (Msg Ctr OGM) is the first step you need to follow before you can turn on the Message Center. Make sure your OGM is less than 20 seconds long.

1 Press **Menu/Set, 2, 7, 1**.

The LCD prompts you to choose an OGM.

| |
|-------------------------|
| Setup Msg Ctr 1. OGM |
|-------------------------|

2 Press **▲** or **▼** to select **Msg Ctr OGM** (not **F/T OGM**).

| |
|--------------------|
| OGM Msg Ctr OGM |
|--------------------|

Press **Menu/Set**.



This is the only setting you can select if you want to turn on the Message Center.

3 Press **▲** or **▼** to select **Record OGM**.

Press **Menu/Set**.

4 Pick up the handset to record a message.

For example: Hello. We are unable to take your call at this time. Please leave a message after the signal. If you wish to send a fax, please press *** 5 1**, wait for fax tones, then press the Start button.

5 Replace the handset.

The Message Center will play your OGM.

6 Press **Stop/Exit**.

Listening to Outgoing Message (OGM)

- 1 Press **Menu/Set**, **2**, **7**, **1**.
- 2 Press **▲** or **▼** to select `Msg Ctr OGM`
(or `F/T OGM`).
Press **Menu/Set**.
- 3 Press **▲** or **▼** to select `Play OGM`.
Press **Menu/Set**.
Adjust the volume by pressing `Volume` **◀** or **▶** .
- 4 Press **Stop/Exit**.

| |
|-------------------------|
| Setup Msg Ctr 1. OGM |
|-------------------------|

Erasing Outgoing Message (OGM)

- 1 Press **Menu/Set**, **2**, **7**, **1**.
- 2 Press **▲** or **▼** to select `Msg Ctr OGM`
(not `F/T OGM`).
Press **Menu/Set**.
- 3 Press **▲** or **▼** to select `Erase OGM`.
Press **Menu/Set**.
- 4 Press **1** to erase the OGM.
—OR—
Press **2** to exit without erasing.
- 5 Press **Stop/Exit**.

| |
|-------------------------|
| Setup Msg Ctr 1. OGM |
|-------------------------|

Activating Message Center mode

Press and hold  until it lights and the LCD shows:

MC:Msg Ctr

When  light is out, the Message Center is OFF.

(See *Setting up the Message Center* on page 7-1.)

Message indicator

The  light flashes when you have *new* voice messages waiting for your review.

The LCD displays the total number of voice and fax messages stored in the Message Center memory.

Voice:03 Fax:00



Fax messages will be stored only when Fax Storage is turned on (**Menu/Set, 2, 5, 1**).

Playing voice messages

Follow the steps below to listen to voice messages:

1 Press **Play/Record**.

Adjust the Volume by pressing  or .

All messages are played in the order they were recorded. The LCD shows the number of the current message, and the total number of messages.

If Caller ID information was received, the machine beeps during the message and displays the Caller ID information for one second.

During playback, the LCD shows the time and date the message was recorded.

2 Press * (RWD) at the end of the message to repeat a message. Press # (FWD) to skip to the next message. You can press * and # repeatedly until you reach the message you want to play.

3 Press **Stop/Exit**.

Printing a fax message

Once you print a new fax message stored in memory, it is erased from the memory automatically.

1 Press **Play/Record**. After two seconds, the fax machine begins to play voice messages.

2 If the Fax Storage is on and there are fax messages in memory, the LCD shows:

3 To print the faxes, press **1**.

—OR—

Press **2** to exit without printing.

| |
|-------------------------|
| Print Fax 1.Yes 2.No |
|-------------------------|

Erasing incoming messages

You can erase voice messages individually, or all at once.

To erase voice messages individually

1 Press **Play/Record**.

The machine sounds a two-second beep and begins message playback. Each message is preceded by one long beep, and followed by two short beeps.

2 To erase a specific message, press **Erase** immediately after the two short beeps, or while the message is playing.

Erase this Msg.?
1.Yes 2.No

3 Press **1** to erase the message.

—OR—

Press **2** to cancel.

4 Press **Stop/Exit**.

To erase messages all at once

1 Press **Erase**.

2 Press **▲** or **▼** to select erasing all voice messages (**Voice:**), all document messages (**Fax**), or all voice and fax messages (**Erase All Msg.?**).

Erase All Voice?
Select ▲▼ & Set

Press **Menu/Set**.

3 Press **1** to erase.

—OR—

Press **2** to cancel.

4 Press **Stop/Exit**.

Setting Maximum Time for incoming messages

Your machine comes set to receive voice messages up to 30 seconds long. You can change this setting to 60, 120 or 180 seconds.

- 1 Press **Menu/Set**, **2**, **7**, **2**.
- 2 Press **▲** or **▼** to select the maximum time setting for incoming messages (30, 60, 120 or 180 seconds).

Press **Menu/Set**.

- 3 Press **Stop/Exit**.

Setup Msg Ctr
2.ICM Max.Time

Setting Toll Saver

See *Setting Toll Saver (Msg Ctr mode)* on page 4-4.

ICM Recording Monitor

This feature lets you turn the speaker volume for voice messages **On** or **Off**. When you turn the monitor **Off**, you will not hear messages as they come in.

- 1 Press **Menu/Set**, **2**, **7**, **3**.
- 2 Use **▲** or **▼** to select **Off** (or **On**).

Press **Menu/Set**.

- 3 Press **Stop/Exit**.

Setup Msg Ctr
3.ICM Rec.Monitr

Recording a conversation

If you are using the handset, you can record a telephone conversation by pressing **Play/Record** during the conversation. Your recording can be as long as the Incoming Message Maximum Time. The other party will hear an intermittent beep while recording. To stop recording, press **Stop/Exit**.

Record Fax/Tel Outgoing Announcement (F/T OGM)

This is the announcement played by your Brother machine (not an external TAD) when someone calls and your machine is set to Fax/Tel receive mode. *Although callers hear your announcement, they cannot leave a message.* By choosing **F/T OGM** (not **Msg Ctr OGM**) you can record the announcement using the same steps as for the Message Center outgoing message. (See *Recording Message Center Outgoing Message* on page 7-2.) You can also listen to and erase the F/T OGM the same way, by choosing **F/T OGM** (not **Msg Ctr OGM**). (See *Listening to Outgoing Message (OGM)* on page 7-3 and *Erasing Outgoing Message (OGM)* on page 7-3.)

If you need to review the steps for setting up the Fax/Tel receive mode, see Chapter 4 *Setup Receive*.

8

Printing reports

Fax settings and activity

You need to set up the Transmission Verification Report and Journal Period in the menu table.

Press **Menu/Set, 2, 4, 1.**

—OR—

Press **Menu/Set, 2, 4, 2.**

Report Setting
1.Transmission

Report Setting
2.Journal Period

Customizing the Transmission Verification Report

You can use the Transmission Report as proof that you sent a fax. This report lists the time and date of transmission and whether the transmission was successful (OK). If you select **On** or **On+Image**, the report will print for every fax you send.

If you send a lot of faxes to the same place, you may need more than the job numbers to know which faxes you must send again. Selecting **On+Image** or **Off+Image** will print a section of the fax's first page on the report to help you remember.



When the Verification Report is turned **Off** or **Off+Image**, the Report will only print if there is a transmission error, with **NG** in the **RESULT** column.

1 Press **Menu/Set, 2, 4, 1.**

2 Press **▲** or **▼** to select

Off+Image, On, On+Image or **Off.**

Press **Menu/Set.**

3 Press **Stop/Exit.**

Report Setting
1.Transmission

Setting the Journal Period

You can set the machine to print a journal at specific intervals (every 50 faxes, 6, 12 or 24 hours, 2 or 7 days). If you set the interval to *Off*, you can print the report by following the steps on the next page.

The default setting is *Every 50 Faxes*.

1 Press **Menu/Set, 2, 4, 2**.

| |
|------------------------------------|
| Report Setting 2.Journal Period |
|------------------------------------|

2 Press **▲** or **▼** to choose an interval.

Press **Menu/Set**.

(If you choose 7 days, the LCD will ask you to choose a day on which to begin the 7-day countdown.)

3 Enter the time to begin printing in 24-hour format.

Press **Menu/Set**.

(For example: enter 19:45 for 7:45 PM.)

4 Press **Stop/Exit**.



If you select 6, 12, 24 hours, 2 or 7 days, the machine will print the report at the selected time and then erase all jobs from its memory. If the machine's memory becomes full with 200 jobs before the time you selected has passed, the machine will print the Journal early and then erase all jobs from memory. If you want an extra report before it is due to print, you can print it without erasing the jobs from memory.



If you select *Every 50 Faxes*, the machine will print the Journal when the machine has stored 50 jobs.

Printing reports

Following reports are available:

- | | |
|--------------------------------------|---|
| 1.Help List | Prints the Help List so you can see at-a-glance how to quickly program your machine. |
| 2.Quick-Dial | Lists names and numbers stored in the One-Touch (FAX-2440C only) and Speed-Dial memory, in numerical order. |
| 3.Fax Journal | Lists information about the last incoming and outgoing faxes. (TX means Transmit.) (RX means Receive.) |
| 4.Transmission | Prints a Transmission Verification Report for your last transmission. |
| 5.User Settings | Lists your settings. |
| 6.Network Config (MFC-620CN only) | Lists your Network settings. |

How to print a report



- 1** For FAX-2440C, press **Menu/Set, 4**.
For MFC-620CN, press **Menu/Set, 6**.
- 2** Press **▲** or **▼** to select the report you want.
Press **Menu/Set**.
—OR—
Enter the number of the report you want to print.
For example, press **1** to print the Help List.
- 3** Press **Black Start**.

9 Making copies

Using the machine as a copier

You can use your machine as a copier, making up to 99 copies at a time.

Enter Copy mode

Before making copies, make sure that  (**Copy**) is illuminated in green. If it is not, press  (**Copy**) to enter **Copy** mode. The default setting is Fax. You can change the number of seconds or minutes that the machine stays in Copy mode. (See *Setting the Mode Timer (FAX-2440C only)* on page 2-3 or *Setting the Mode Timer (MFC-620CN only)* on page 2-3.)

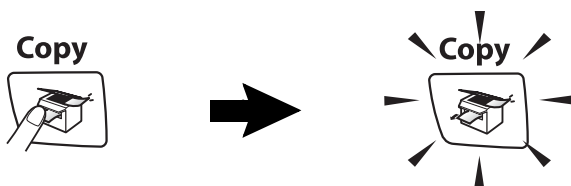

The LCD shows the default copy setting

100% Normal 01

Copy Ratio

Quality

No of Copies

Making a single copy

1 Press  (**Copy**) to illuminate it in green.

2 Load your document.

(See *Load documents* on page 1-7.)

3 Press **Black Start** or **Color Start**.

 To stop copying, press **Stop/Exit**.

Making multiple copies

1 Press  (**Copy**) to illuminate it in green.

2 Load your document.

3 Use the dial pad to enter the number of copies you want (up to 99).

4 Press **Black Start** or **Color Start**.

 To sort the copies, press the **Copy Options** key. (See *Using the Copy Options key (Temporary settings)* on page 9-3.)



Stop copying

To stop copying, press **Stop/Exit**.

Using the Copy Options key (Temporary settings)







When you want to quickly change the copy settings temporarily for the next copy, use the **Copy Options** key. You can use different combinations.



-  These settings are temporary, and the machine returns to its default settings 60 seconds after it finishes copying. However if you have set the Mode Timer to 0 or 30 seconds, the machine returns to the default settings after the number of seconds that has been set for mode timer. (See *Setting the Mode Timer (FAX-2440C only)* on page 2-3 or *Setting the Mode Timer (MFC-620CN only)* on page 2-3.)
-  You can save the copy settings you use most often by setting them as default. (See *Changing the default copy settings* on page 9-13.)

Changing the temporary copy settings

Use the **Copy Options** key to quickly set the following copy settings temporarily for the next copy.

| Press Copy Options | Menu Selections  →   select | Options  →   select | Factory Setting | Page |
|---|--|--|--------------------|------|
|  | Quality | Fast/Normal/Best | Normal | 9-5 |
| | Enlarge/Reduce | 50%/69%/78%/83%/93%/97%/100%/104%/142%/186%/198%/200%/Custom (25-400%) | 100% | 9-6 |
| | Paper Type | Plain/ Inkjet/ Glossy/ Transparency | Plain | 9-7 |
| | Paper Size | Letter/Legal/ A4/A5/ 4" (W) x 6" (H) | Letter | 9-8 |
| | Brightness | - ■■■■ + | - ■■■■ + | 9-8 |
| | Contrast | - ■■■■ + | - ■■■■ + | 9-9 |
| | Stack/Sort | Stack/Sort | Stack | 9-9 |
| | Page Layout | Off(1 in 1)/ 2 in 1 (P)/ 2 in 1 (L)/ 4 in 1 (P)/ 4 in 1 (L)/ Poster (3 x 3) | Off (1 in 1) | 9-13 |
| | No. of Copies | No. of Copies:01 (01-99) | 01 | |

After you choose your settings by pressing **Menu/Set**, the LCD shows **Set** temporarily.

Press **Black Start** or **Color Start** if you're finished choosing settings.

—OR—

Press **▲** or **▼** to select more settings.

Increasing copy speed or quality

You can select the copy quality. The default setting is *Normal*.

| | |
|--------|---|
| Normal | Recommended mode for ordinary printouts. Good copy quality with adequate copy speed. |
| Fast | Fast copy speed and lowest ink consumption. Use FAST to save time (document to be proof-read, large documents or many copies). |
| Best | Use this mode to copy precise images such as photographs. BEST uses the highest resolution and slowest speed. |

- 1 Press  (**Copy**) to illuminate it in green.
- 2 Load your document.
- 3 Use the dial pad to enter the number of copies you want (up to 99).
- 4 Press **Copy Options** and ▲ or ▼ to select *Quality*.
Press **Menu/Set**.
- 5 Press ▲ or ▼ to choose the copy quality (*Fast*, *Normal* or *Best*).
Press **Menu/Set**.
- 6 Press **Black Start** or **Color Start**.

Enlarging or reducing the image copied

You can select the following enlargement or reduction ratios.

Custom (25-400%) allows you to enter a ratio from 25% to 400%.

| | |
|--|------------------|
| Press Copy Options  and ▲ or ▼ to select Enlarge/Reduce | Custom (25-400%) |
| | 200% |
| | 198% 4"x6"→A4 |
| | 186% 4"x6"→LTR |
| | 142% A5→A4 |
| | 104% EXE→LTR |
| | 100% |
| | 97% LTR→A4 |
| | 93% A4→LTR |
| | 83% LGL→A4 |
| | 78% LGL→LTR |
| | 69% A4→A5 |
| | 50% |

- 1 Press  (**Copy**) to illuminate it in green.
- 2 Load your document.
- 3 Use the dial pad to enter the number of copies you want (up to 99).
- 4 Press **Copy Options** and ▲ or ▼ to select *Enlarge/Reduce*.
- 5 Press ▲ or ▼ to select the enlargement or reduction ratio you want.

Press **Menu/Set**.

—OR—

You can select *Custom (25-400%)* and press **Menu/Set**.

Use the dial pad to enter an enlargement or reduction ratio from 25% to 400%.

Press **Menu/Set**.

(For example, press **5 3** to enter 53%.)

6 Press **Black Start** or **Color Start**.



Special Copy Options 2in1(P), 2in1(L), 4in1(P), 4in1(L) or Poster are not available with Enlarge/Reduce.

Setting paper type

If you are copying on special paper, be sure to select the type of paper you are using so you will get the best print quality.

- 1 Press  (**Copy**) to illuminate it in green.
- 2 Load your document.
- 3 Use the dial pad to enter the number of copies you want (up to 99).
- 4 Press **Copy Options** and ▲ or ▼ to select Paper Type.
Press **Menu/Set**.
- 5 Press ▲ or ▼ to select the type of paper you are using (Plain, Inkjet, Glossy or Transparency).
Press **Menu/Set**.
- 6 Press **Black Start** or **Color Start**.



You can change the default Paper Type setting at any time. (See *Setting the Paper Type* on page 2-4.)

Setting paper size

If copying on paper other than Letter size, you will need to change the paper size setting.

 You can copy only on Letter, Legal, A4, A5 or Photo Card (4"(W) x 6"(H)) paper.

- 1 Press  (**Copy**) to illuminate it in green.
- 2 Load your document.
- 3 Use the dial pad to enter the number of copies you want (up to 99).
- 4 Press **Copy Options** and ▲ or ▼ to select *Paper Size*. Press **Menu/Set**.
- 5 Press ▲ or ▼ to select the size of paper you are using (Letter, Legal, A4, A5 or 4 " (W) x 6 " (H)). Press **Menu/Set**.
- 6 Press **Black Start** or **Color Start**.

Adjusting brightness

You can adjust the copy brightness to make copies darker or lighter.

- 1 Press  (**Copy**) to illuminate it in green.
- 2 Load your document.
- 3 Use the dial pad to enter the number of copies you want (up to 99).
- 4 Press **Copy Options** and ▲ or ▼ to select *Brightness*. Press **Menu/Set**.

- 5 Press ▲ to make a lighter copy.

—OR—

Press ▼ to make a darker copy.

Press **Menu/Set**.

- 6 Press **Black Start** or **Color Start**.



Adjusting contrast

You can adjust the copy contrast to help an image look sharper and more vivid.

- 1 Press  (**Copy**) to illuminate it in green.
- 2 Load your document.
- 3 Use the dial pad to enter the number of copies you want (up to 99).
- 4 Press **Copy Options** and ▲ or ▼ to select `Contrast`.
Press **Menu/Set**.
- 5 Press ▲ to increase the contrast.
—OR—
Press ▼ to decrease the contrast.
Press **Menu/Set**.
- 6 Press **Black Start** or **Color Start**.



Sorting copies using the ADF

You can sort multiple copies. Pages will be stacked in the order 321, 321, 321, and so on.

- 1 Press  (**Copy**) to illuminate it in green.
- 2 Load your document.
- 3 Use the dial pad to enter the number of copies you want (up to 99).
- 4 Press **Copy Options** and ▲ or ▼ to select `Stack/Sort`.
Press **Menu/Set**.
- 5 Press ▲ or ▼ to select `Sort`.
Press **Menu/Set**.
- 6 Press **Black Start** or **Color Start**.

Making N in 1 copies or a poster (Page Layout)

You can reduce the amount of copies by using the N in 1 copy feature. This allows you to copy two or four pages on one page, which allows you to save paper. It is also possible to create a poster. When you use the Poster feature your machine divides your document into sections, then enlarges the sections so you can assemble them into a poster. If you want to print a poster, use the scanner glass.



- Please make sure Paper Size is set to Letter or A4.
- You can use N in 1 copy feature with 100% copy size only.
- (P) means Portrait and (L) means Landscape.

- 1 Press  (**Copy**) to illuminate it in green.
- 2 Load your document.
- 3 Use the dial pad to enter the number of copies you want (up to 99).
- 4 Press **Copy Options** and ▲ or ▼ to select Page Layout.
Press **Menu/Set**.
- 5 Press ▲ or ▼ to select 2 in 1 (P), 2 in 1 (L), 4 in 1 (P), 4 in 1 (L), Poster (3 x 3) or Off (1 in 1).
Press **Menu/Set**.
- 6 Press **Black Start** or **Color Start** to scan the document.
- 7 If you are making a poster or placed the document in the ADF, the machine scans the page and starts printing.

If you are using the scanner glass:

8 After the machine scans the page, the LCD shows:

Next Page?
1.Yes 2.No

Press **1** to scan the next page.

9 Put the next document on the scanner glass.

Set Next Page
Then Press Set

Press **Menu/Set**.

Repeat Steps 8 and 9 for each page of the layout.

10 After all the pages of the document have been scanned, press **2** to end.



If **Glossy** has been selected in the Paper Type setting for N in 1 copies, the machine will print the images as if Plain paper had been selected.



- If you are producing multiple color copies, N in 1 copies are not available.
- N in 1 color copies are not available for FAX-2440C.
- For Poster copies, you cannot make more than one copy.

Place document face *down* in the direction shown below.

2 in 1 (P)



2 in 1 (L)

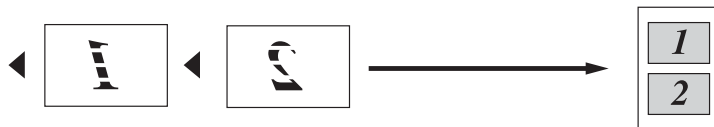

4 in 1 (P)



4 in 1 (L)



Poster (3X3)

You can make a poster size copy of a photograph.

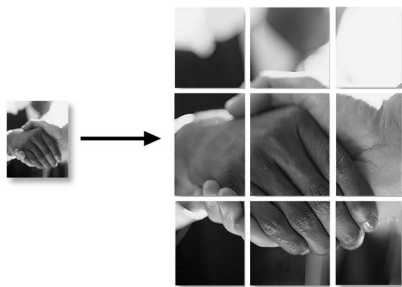

Changing the default copy settings

You can save the copy settings you use most often by setting them as default. These settings will remain until you change them again.

Increasing copy speed or quality

- 1 Press **Menu/Set**, **3**, **1**.
- 2 Press **▲** or **▼** to select **Normal**, **Best** or **Fast**.
Press **Menu/Set**.
- 3 Press **Stop/Exit**.

Copy
1.Quality

Adjusting brightness

- 1 Press **Menu/Set**, **3**, **2**.
- 2 Press **▲** to make a lighter copy.
—OR—
Press **▼** to make a darker copy.
Press **Menu/Set**.
- 3 Press **Stop/Exit**.

Copy
2.Brightness

Adjusting contrast

You can change the contrast to help an image look sharper and more vivid.

- 1 Press **Menu/Set**, **3**, **3**.
- 2 Press **▲** to increase the contrast.
—OR—
Press **▼** to decrease the contrast.
Press **Menu/Set**.
- 3 Press **Stop/Exit**.

Copy
3.Contrast

Adjusting color saturation

1 Press **Menu/Set**, **3**, **4**.

2 Press **▲** or **▼** to select **Red**, **Green** or **Blue**.

| |
|------------------------|
| Copy 4.Color Adjust |
|------------------------|

Press **Menu/Set**.

3 Press **▲** to increase the color saturation.

—OR—

Press **▼** to decrease the color saturation.

Press **Menu/Set**.

4 Return to Step 2 to select the next color.

—OR—

Press **Stop/Exit**.

Out of Memory message

If the memory becomes full while you are making copies, the LCD message will guide you through the next step.

If the **Out of Memory** message appears, press **Stop/Exit** to cancel or **Black Start** or **Color Start** to copy the scanned pages. You will need to clear some jobs from the memory before you can continue.



To gain extra memory, you can turn off Fax Storage.
(See *Setting Fax Storage* on page 6-3.)

—OR—

Print the faxes that are in the memory.

(See *Printing a fax from the memory* on page 4-8.)

When you get an **Out of Memory** message, you may be able to make copies if you first print incoming faxes in the memory to restore the memory to 100%.

Legal limitations

Color reproductions of certain documents are illegal and may result in either criminal or civil liability. This memorandum is intended to be a guide rather than a complete listing of every possible prohibition. In case of doubt, we suggest that you check with counsel as to any particular questionable documents.

The following documents issued by the United States/Canadian Government or any of its Agencies may not be copied:

- Money
- Bonds or other certificates of indebtedness
- Certificates of Deposit
- Internal Revenue Stamps (canceled or uncanceled)
- Selective Service or draft papers
- Passports
- United States/Canadian Postage Stamps (canceled or uncanceled)
- Food Stamps
- Immigration Papers
- Checks or drafts drawn by Governmental agencies
- Identifying badges or insignias

Copyrighted works cannot be copied. Sections of a copyrighted work can be copied for 'fair use.' Multiple copies would indicate improper use.

Works of art should be considered the equivalent of copyrighted works.

Licenses and Certificates of Title to motor vehicles may not be copied under certain state/provincial laws.

10 Walk-Up PhotoCapture Center™ (MFC-620CN only)

Introduction

Even if your machine is not connected to your computer, you can print photos directly from the digital camera media. Your Brother machine includes five media drives (slots) for use with popular digital camera media: CompactFlash®, SmartMedia®, Memory Stick®, SecureDigital™, and xD-Picture Card™.

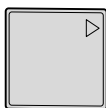

CompactFlash®



SmartMedia®



Memory Stick®



SecureDigital™



xD-Picture Card™

The PhotoCapture Center™ feature lets you print digital photos from your digital camera at high resolution to get photo quality printing.



- miniSD™ can be used with miniSD™ adapter.
- Memory Stick Duo™ can be used with Memory Stick Duo™ adapter.
- Adapters are not included with the machine. Contact a third party supplier for adapters.

PhotoCapture Center™ requirements

To avoid error conditions, please remember:

- The DPOF file on the media card must be in a valid format. (See *DPOF printing* on page 10-8.)
- The image file extension must be .JPG (Other image file extensions .JPEG, .TIF, .GIF and so on will not be recognized).
- Walk-up PhotoCapture Center™ printing must be performed separately from PhotoCapture Center™ operations using the PC. (Simultaneous operation is not available.)
- IBM Microdrive™ is not compatible with the machine.
- The machine can read up to 999 files in a media card.
- Use only Smart media cards with a 3.3v voltage rating.



When printing the INDEX or IMAGE, the PhotoCapture Center™ will print all the valid images, even if one or more images have been corrupted. A portion of the corrupted image may be printed.



Your machine is designed to read media cards that have been formatted by a digital camera.

When a digital camera formats a media card it creates a special folder into which it copies image data. If you need to modify the image data stored on a media card with your PC, we recommend that you do not modify the folder structure created by the digital camera. When saving new or modified image files to the media card we also recommend you use the same folder your digital camera uses. If the data is not saved to the same folder the machine may not be able to read the file or print the image.

Getting started

Firmly insert the card into the appropriate slot.

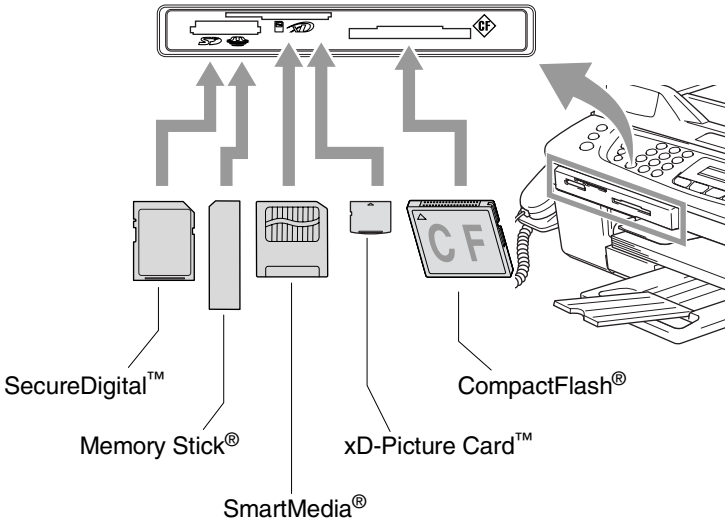

PhotoCapture key lights:

- **PhotoCapture** light is ON, the media card is inserted properly.
- **PhotoCapture** light is OFF, the media card is not properly inserted.
- **PhotoCapture** light is BLINKING, the media card is being read or written to.

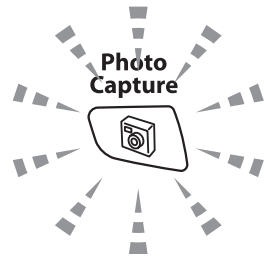

- ⚠ Do NOT unplug the power cord or remove the media card from the media drive (slot) while the machine is reading or writing to the card (the **PhotoCapture** key is blinking). **You will lose your data or damage the card.**

The machine can only read one media card at a time so do not insert more than one card.

The steps below give a brief outline of the Direct Printing feature. Please see the remaining pages of this chapter for more detailed instructions.

- 1** Insert the media card firmly into the media drive (slot).

When you insert your media card into the proper slot, the LCD shows.

C.Flash Active
Press PhotoCapture key...



The media active message will be shown for 60 seconds and then disappear. Even in that case, you can enter the PhotoCapture mode by pressing **PhotoCapture**.

- 2** Press **PhotoCapture**.

If your digital camera supports DPOF printing, see *DPOF printing* on page 10-8.

- 3** Print the index which shows thumbnails views of images stored on your media card. Your machine will give an image number to each thumbnail.

Press **▲** or **▼** to select `Print Index` and then press **Menu/Set**.

Press **Color Start** to start printing the index sheet.

(See *Printing the Index (Thumbnails)* on page 10-5.)

- 4** To print images, press **▲** or **▼** to select `Print Images` and then press **Menu/Set**.

Enter the image number and press **Menu/Set**.

Press **Color Start** to start printing.

(See *Printing images* on page 10-6.)



You can change the settings for printing images, such as the Paper Type & Paper Size, Print Size and number of copies.

(See *Printing images* on page 10-6.)

Printing the Index (Thumbnails)

The PhotoCapture Center™ assigns numbers for images (such as No.1, No.2, No.3, and so on).



▶ No. 1
DEI.JPG

01.01.2003
100KB

It does not recognize any other numbers or file names that your digital camera or PC have used to identify the pictures. You can print a thumbnail page (Index page with 6 or 5 images per line). This will show all the pictures on the media card.

- 1** Make sure you have inserted the media card.
Press **PhotoCapture**. (See page 10-3.)
- 2** Press **▲** or **▼** to select `Print Index`.
Press **Menu/Set**.
- 3** Press **▲** or **▼** to select `6 Images/Line` or `5 Images/Line`.
Press **Menu/Set**.

Index



5 Images/Line

Index

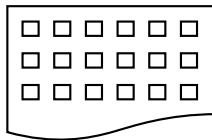

6 Images/Line

- 4** Press **Color Start** to start printing.
-  Print time for 5 Images/Line will be slower than 6 Images/Line, but the quality is better. To print an image, see *Printing images* on page 10-6.

Printing images

Before you can print an individual image, you have to know the image number.



Print the Index first.

(See *Printing the Index (Thumbnails)* on page 10-5.)

1 Make sure you have inserted the media card.

Press **PhotoCapture**. (See page 10-3.)

2 Press **▲** or **▼** to choose *Print Images*.

Press **Menu/Set**.



If your media card contains valid DPOF information, the LCD shows *DPOF Print: Yes, please go to DPOF printing* on page 10-8.

3 Use the dial pad to enter the image number that you want to print from the Index page (Thumbnails).

| |
|-------------------------------|
| Enter & Set Key No. : 1, 3 |
|-------------------------------|

Press **Menu/Set**.

Repeat this step until you have entered all the image numbers that you want to print.



You can enter all the numbers at one time by using the ***** key for a comma or the **#** key for hyphen.

(For example, Enter **1 * 3 * 6** - to print images No.1, No.3 and No.6. Enter **1 # 5** to print images No.1 to No.5).

4 After you have selected all the image numbers, press **Menu/Set** again, and go to Step 5.

—**OR**—

If you have finished choosing settings, press **Color Start**.

Paper Type & Paper Size

- 5** Press ▲ or ▼ to select the type of paper you are using, Letter Glossy, 4"x 6" Glossy, 5"x 7" Glossy, A4 Glossy, Letter Plain, A4 Plain, Letter Inkjet, A4 Inkjet or 4"x 6" Inkjet.

Press **Menu/Set**.

If you selected Letter or A4, go to Step 6.

If you selected another size, go to Step 7.

—OR—

If you have finished choosing settings, press **Color Start**.

Print Size







- 6** If you selected Letter or A4, press ▲ or ▼ to select the print size (4"x 3", 5"x 3.5", 6"x 4", 7"x 5", 8"x 6" or Max. Size).

Press **Menu/Set**, and go to Step 7.

—OR—

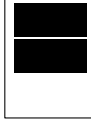
If you have finished choosing settings, press **Color Start**.

Printed Position for Letter paper

| ① 4"x 3" | ② 5"x 3.5" | ③ 6"x 4" | ④ 7"x 5" | ⑤ 8"x 6" | ⑥ Max. Size |
|--|--|--|--|--|--|
|  |  |  |  |  |  |

Number of Copies

- 7** Use the dial pad to enter the number of copies you want.

Press **Menu/Set**.

- 8** Press **Color Start** to print.

DPOF printing

DPOF stands for Digital Print Order Format.

Major Digital Camera manufacturers (Canon Inc., Eastman Kodak Company, Fuji Photo Film Co. Ltd., Matsushita Electric Industrial Co. Ltd. and Sony Corporation.) created this standard to make it easier to print images from a digital camera.

If your digital camera supports DPOF printing, you will be able to select on the Digital Camera display the images and number of copies you want to print.

When the memory card (CompactFlash®, SmartMedia®, Memory Stick®, SecureDigital™ and xD-Picture Card™) with DPOF information is put into your machine, you can print the selected image easily.

- 1 Insert your media card into the proper drive (slot).

C.Flash Active
Press PhotoCapture key...



The media active message will be shown for 60 seconds and then disappear. Even in that case, you can enter the PhotoCapture mode by pressing **PhotoCapture**.

- 2 Press **PhotoCapture**.
- 3 Press **▲** or **▼** to select `Print Images`.
Press **Menu/Set**.

- 4 If there is a DPOF file on the card, the LCD shows:

Select **▲▼** & Set
DPOF Print:Yes

- 5 Press **▲** or **▼** to select `DPOF Print:Yes`.
Press **Menu/Set**.



If you want to choose the images and their print options now, select `DPOF Print:No`.

- 6 Press **Color Start** to print.

Changing the default settings

You can save the PhotoCapture Center™ settings you use most often by setting them as default. These settings will remain until you change them again.

Increasing print speed or quality

- 1 Press **Menu/Set**, **4**, **1**.
- 2 Press **▲** or **▼** to select **Normal** or **Photo**.
Press **Menu/Set**.
- 3 Press **Stop/Exit**.

PhotoCapture
1.Print Quality

Setting the paper & size

- 1 Press **Menu/Set**, **4**, **2**.
- 2 Press **▲** or **▼** to select
Letter Glossy, **4"x 6" Glossy**,
5"x 7" Glossy, **A4 Glossy**, **Letter Plain**, **A4 Plain**,
Letter Inkjet, **A4 Inkjet** or **4"x 6" Inkjet**.
Press **Menu/Set**.
If you selected **Letter** or **A4**, press **▲** or **▼** to select the print size
(**4"x 3"**, **5"x 3.5"**, **6"x 4"**, **7"x 5"**, **8"x 6"** or
Max. Size).
Press **Menu/Set**.
- 3 Press **Stop/Exit**.

PhotoCapture
2.Paper & Size

Adjusting brightness

- 1 Press **Menu/Set**, **4**, **3**.
- 2 Press **▲** to make a lighter print.
—OR—
Press **▼** to make a darker print.
Press **Menu/Set**.
- 3 Press **Stop/Exit**.

PhotoCapture
3.Brightness

Adjusting contrast

You can choose the contrast setting. More contrast will make an image look sharper and more vivid.

- 1 Press **Menu/Set**, **4**, **4**.
- 2 Press **▲** to increase the contrast.

| |
|----------------------------|
| PhotoCapture 4.Contrast |
|----------------------------|

—OR—

Press **▼** to decrease the contrast.

Press **Menu/Set**.

- 3 Press **Stop/Exit**.

Color enhancement (True2Life®)

You can turn on the color enhancement (True2Life®) feature to print more vivid images. Printing time will be slower.

- 1 Press **Menu/Set**, **4**, **5**.
- 2 Press **▲** or **▼** to select **On**.

| |
|-----------------------------|
| PhotoCapture 5.True2Life |
|-----------------------------|

Press **Menu/Set**.

—OR—

Select **Off** and press **Menu/Set**, then go to Step 5.



If you select **On**, you can customize the **White Balance**, **Sharpness** or **Color Density**.

- 3 Press **▲** or **▼** to select **White Balance**, **Sharpness** or **Color Density**.

Press **Menu/Set**.

- 4 Press **▲** or **▼** to adjust the degree of the setting.

Press **Menu/Set**.

- 5 Press **Stop/Exit**.

■ **White Balance**

This setting adjusts the hue of the white areas of an image. Lighting, camera settings and other influences will effect the appearance of white. The white areas of a picture may be slightly pink, yellow or some other color. By using this adjustment you can correct this effect and bring the white areas back to pure white.

■ **Sharpness**

This setting enhances the detail of an image. It is similar to adjusting the fine focus on a camera. If the image is not in true focus and you cannot see the fine details of the picture, then adjust the sharpness.

■ **Color Density**

This setting adjusts the total amount of color in the image. You can increase or decrease the amount of color in an image to improve a washed out or weak picture.

Cropping

If your photo is too long or wide to fit the available space on your selected layout, part of the image will be automatically cropped.

The default setting is **On**. If you want to print the whole image, turn this setting to **Off**.

- 1 Press **Menu/Set, 4, 6**.
- 2 Press **▲** or **▼** to select **Off** (or **On**).
Press **Menu/Set**.
- 3 Press **Stop/Exit**.

Cropping:On

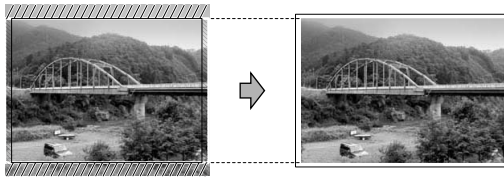

Cropping:Off

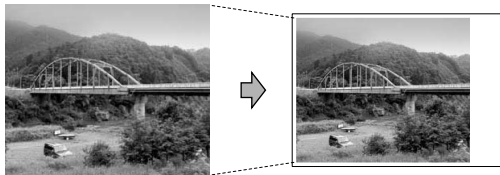

Borderless

This feature expands the printable area to the edges of the paper. Printing time will be slightly slower.

- 1 Press **Menu/Set, 4, 7**.
- 2 Press **▲** or **▼** to select **Off** (or **On**).
Press **Menu/Set**.
- 3 Press **Stop/Exit**.

Understanding the Error Messages

Once you are familiar with the types of errors that can occur while you're using the PhotoCapture Center™, you can easily identify and troubleshoot any difficulties.

When an error message appears on the LCD, the machine will beep to get your attention.

Media Error—This message will appear if you insert a media card that is either bad or not formatted, or when there is a problem with the media drive. To clear this error, take out the media card.

No File—This message will appear if you try to access a media card in the drive (slot) that does not contain a .JPG file.

Out of Memory—This message will appear if you are working with images that are too large for the machine's memory.

Using PhotoCapture Center™ from your PC

You can access the media card that is in the media drive (slot) of the machine from your PC.

(See *Using the PhotoCapture Center™ from your PC* on page 6-1 in Software User's Guide on the CD-ROM or *Using the PhotoCapture Center™ from a Macintosh®* (not available for MFC-3240C and MFC-5440CN) on page 8-45 in the Software User's Guide on the CD-ROM.)

Using PhotoCapture Center™ for scanning documents

You can scan documents and save them on a media card to quickly and easily make documents portable. (See *Scan to Card* (not available for MFC-3240C, MFC-210C and MFC-5440CN) on page 2-23 in Software User's Guide on the CD-ROM.)

11 Important information

Standard telephone and FCC Notices

These notices are in effect on models sold and used in the United States only.

This equipment is hearing-aid compatible.

When programming emergency numbers or making test calls to emergency numbers:

- Remain on the line and briefly explain to the dispatcher the reason for the call before hanging up.
- Perform these activities in the off-peak hours, such as early morning or late evening.

This equipment complies with Part 68 of the FCC rules and the requirements adopted by the ACTA. On the backside of this equipment is a label that contains, among other information, a product identifier in the format US: AAAEQ##TXXXX. If requested, this number must be provided to the telephone company.

You may safely connect this equipment to the telephone line by means of a standard modular jack, USOC RJ11C.

A plug and jack used to connect this equipment to the premises wiring and telephone network must comply with the applicable FCC Part 68 rules and requirements adopted by the ACTA. A compliant telephone cord and modular plug is provided with this product. It is designed to be connected to a compatible modular jack that is also compliant. See installation instructions for details.

The REN is used to determine the number of devices that may be connected to a telephone line. Excessive RENs on a telephone line may result in the devices not ringing in response to an incoming call. In most but not all areas, the sum of RENs should not exceed five (5.0). To be certain of the number of devices that may be connected to a line, as determined by the total RENs, contact the local telephone company. For products approved after July 23, 2001, the REN for this product is part of the product identifier that has the format US:AAAEQ##TXXXX. The digits represented by ## are the REN without a decimal point (e.g., 06 is a REN of 0.6). For earlier products, the REN is separately shown on the label.

If this equipment causes harm to the telephone network, the telephone company will notify you in advance that temporary discontinuance of service may be required. But if advance notice isn't practical, the telephone company will notify the customer as soon as possible. Also, you will be advised of your right to file a complaint with the FCC if you believe it is necessary.

The telephone company may make changes in its facilities, equipment, operations or procedures that could affect the operation of the equipment. If this happens the telephone company will provide advance notice in order for you to make necessary modifications to maintain uninterrupted service.

If trouble is experienced with this equipment, for repair or warranty information, please contact Brother Customer Service. (See *Brother numbers* on page i.) If the equipment is causing harm to the telephone network, the telephone company may request that you disconnect the equipment until the problem is resolved.

Connection to party line service is subject to state tariffs. Contact the state public utility commission, public service commission or corporation commission for information.

If your home has specially wired alarm equipment connected to the telephone line, ensure the installation of this equipment does not disable your alarm equipment. If you have questions about what will disable alarm equipment, call your telephone company or a qualified installer.

If you are not able to solve a problem with your machine, call Brother Customer Service. (See *Brother numbers* on page i.)

 **WARNING**

For protection against the risk of electrical shock, always disconnect all cables from the wall outlet before servicing, modifying or installing the equipment.

This equipment may not be used on coin service lines provided by the telephone company or connected to party lines.

Brother cannot accept any financial or other responsibilities that may be the result of your use of this information, including direct, special or consequential damages. There are no warranties extended or granted by this document.

WARNING

This machine has been certified to comply with FCC standards, which are applied to the USA only. A grounded plug should be plugged into a grounded AC power outlet after checking the rating of the local power supply for the machine to operate properly and safely.

Federal Communications Commission (FCC) Declaration of Conformity (USA only)

Responsible Party: Brother International Corporation
100 Somerset Corporate Boulevard
Bridgewater, NJ 08807-0911 USA
TEL: (908) 704-1700

declares, that the products

Product Name: FAX-2440C, MFC-620CN

comply with Part 15 of the FCC Rules. Operation is subject to the following two conditions: (1) This device may not cause harmful interference, and (2) this device must accept any interference received, including interference that may cause undesired operation.

This equipment has been tested and found to comply with the limits for a Class B digital device, pursuant to Part 15 of the FCC Rules. These limits are designed to provide reasonable protection against harmful interference in a residential installation. This equipment generates, uses, and can radiate radio frequency energy and, if not installed and used in accordance with the instructions, may cause harmful interference to radio communications. However, there is no guarantee that interference will not occur in a particular installation. If this equipment does cause harmful interference to radio or television reception, which can be determined by turning the equipment off and on, the user is encouraged to try to correct the interference by one or more of the following measures:

- Reorient or relocate the receiving antenna.
- Increase the separation between the equipment and receiver.
- Connect the equipment into an outlet on a circuit different from that to which the receiver is connected.
- Call the dealer or an experienced radio/TV technician for help.

Important

Changes or modifications not expressly approved by Brother Industries, Ltd. could void the user's authority to operate the equipment.

Industry Canada Compliance Statement (Canada only)

This Class B digital apparatus complies with Canadian ICES-003.
Cet appareil numérique de la classe B est conforme à la norme NMB-003 du Canada.

For your safety

To ensure safe operation the supplied three-pin plug must be inserted only into a standard three-pin AC power outlet that is effectively grounded through the normal household wiring.

The fact that the equipment operates satisfactorily does not imply that the power is grounded and that the installation is completely safe. For your safety, if in any doubt about the effective grounding of the power, call a qualified electrician.

LAN connection (MFC-620CN only)

Caution

Do not connect this product to a LAN connection that is subject to over-voltages.

International ENERGY STAR® Compliance Statement

The purpose of the International ENERGY STAR® Program is to promote the development and popularization of energy-efficient office equipment.

As an ENERGY STAR® Partner, Brother Industries, Ltd. has determined that this product meets the ENERGY STAR® guidelines for energy efficiency.



Important safety instructions

- 1** Read all of these instructions.
- 2** Save them for later reference.
- 3** Follow all warnings and instructions marked on the product.
- 4** Unplug this product from the wall outlet before cleaning. Do not use liquid or aerosol cleaners. Use a damp cloth for cleaning.
- 5** Do not use this product near water.
- 6** Do not place this product on an unstable cart, stand, or table. The product may fall, causing serious damage to the product.
- 7** Slots and openings in the cabinet and the back or bottom are provided for ventilation; to ensure reliable operation of the product and to protect it from overheating, these openings must not be blocked or covered. The openings should never be blocked by placing the product on a bed, sofa, rug, or other similar surface. This product should never be placed near or over a radiator or heater. This product should never be placed in a built-in installation unless proper ventilation is provided.
- 8** This product should be operated from the type of power source indicated on the label. If you are not sure of the type of power available, call your dealer or local power company.
Use only the power cord supplied with this machine.
- 9** This product is equipped with a 3-wire grounded plug, a plug having a third (grounded) pin. This plug will only fit into a grounded power outlet. This is a safety feature. If you are unable to insert the plug into the outlet, call your electrician to replace your obsolete outlet. Do not defeat the purpose of the grounded plug.
- 10** Do not allow anything to rest on the power cord. Do not place this product where people can walk on the cord.
- 11** If an extension cord is used with this product, make sure that the total ampere ratings on the products plugged into the extension cord do not exceed the extension cord ampere rating. Also, make sure that the total of all products plugged into the AC power outlet does not exceed 15 amperes (USA only).

- 12** Do not place anything in front of the machine that will block received faxes. Do not place anything in the path of received faxes.
- 13** Wait until pages have exited the machine before picking them up.
- 14** Never push objects of any kind into this product through cabinet slots, since they may touch dangerous voltage points or short out parts resulting in the risk of fire or electric shock. Never spill liquid of any kind on the product. Do not attempt to service this product yourself because opening or removing covers may expose you to dangerous voltage points and other risks and may void your warranty. Refer all servicing to a Brother Authorized Service Center. For the location of your nearest Brother Authorized Service Center, please call
In USA: 1-800-284-4357 or **In Canada:** 1-877-BROTHER.
(See *Brother numbers* on page i.)
- 15** Unplug this product from the AC power outlet and refer servicing to Authorized Service Personnel under the following conditions:
- When the power cord is damaged or frayed.
 - If liquid has been spilled into the product.
 - If the product has been exposed to rain or water.
 - If the product does not operate normally when the operating instructions are followed. Adjust only those controls that are covered by the operating instructions. Improper adjustment of other controls may result in damage and will often require extensive work by a qualified technician to restore the product to normal operation.
 - If the product has been dropped or the cabinet has been damaged.
 - If the product exhibits a distinct change in performance, indicating a need for service.
- 16** To protect your product against power surges, we recommend the use of a power protection device (Surge Protector).

Trademarks

The Brother logo is a registered trademark of Brother Industries, Ltd.

Brother is a registered trademark of Brother Industries, Ltd.

Multi-Function Link is a registered trademark of Brother International Corporation.

© 2004 Brother Industries, Ltd. All rights reserved.

Windows and Microsoft are registered trademarks of Microsoft in the U.S. and other countries.

Macintosh and TrueType are registered trademarks of Apple Computer, Inc.

PaperPort and OmniPage OCR are registered trademarks of ScanSoft, Inc.

Presto! PageManager is a registered trademark of NewSoft Technology Corporation.

Microdrive is a trademark of International Business Machine Corporation.

SmartMedia is a registered trademark of Toshiba Corporation.

CompactFlash is a registered trademark of SanDisk Corporation.

Memory Stick is a registered trademark of Sony Corporation.

SecureDigital is a trademark of Matsushita Electric Industrial Co. Ltd., SanDisk Corporation and Toshiba Corporation.

SanDisk is a licensee of the SD and miniSD trademarks.

xD-Picture Card is a trademark of Fujifilm Co. Ltd., Toshiba Corporation and Olympus Optical Co. Ltd.

Memory Stick Duo and MagicGate are trademarks of Sony Corporation.

Each company whose software title is mentioned in this manual has a Software License Agreement specific to its proprietary programs.

All other brand and product names mentioned in this User's Guide, the Software User's Guide, and the Network User's Guide (MFC-620CN only) are registered trademarks of their respective companies.

12 Troubleshooting and routine maintenance

Troubleshooting

IMPORTANT

For technical help, you must call the country where you bought the machine. Calls must be made *from within* that country.

Error messages

As with any sophisticated office product, errors may occur. If this happens, your machine identifies the problem and displays an error message. The most common error messages are shown below.

You can correct most problems by yourself. If you need additional help, the Brother Solutions Center offers latest FAQs and troubleshooting tips.

Visit us at <http://solutions.brother.com>.

| ERROR MESSAGES | | |
|-----------------|---|---|
| ERROR MESSAGE | CAUSE | ACTION |
| Comm. Error | Poor phone line quality caused a communication error. | Try the call again. If the problem continues, call the telephone company and ask them to check your phone line. |
| Connection Fail | You tried to poll a fax machine that is not in Polled Waiting mode. | Check the other fax machine's polling setup. |
| Cover is Open | The scanner cover is not closed completely. | Lift the scanner cover and then close it again. |
| Data Remaining | Print data remains in the machine's memory. | Re-start printing from your computer. |
| | Print data remains in the machine's memory. The USB cable was unplugged while the computer was sending the data to the machine. | Press Stop/Exit . The machine will cancel the job and eject the page that is being printed. |
| Disconnected | The other person or other person's fax machine stopped the call. | Try to send or receive again. |

| ERROR MESSAGES | | |
|------------------------------|---|---|
| ERROR MESSAGE | CAUSE | ACTION |
| Document Jam | The document scanned from ADF was longer than about 35.4 inches. | See <i>Using the automatic document feeder (ADF)</i> on page 1-7. |
| | The document is jammed in the machine. | See <i>Document jams</i> on page 12-5. |
| DR Mode in Use | The machine is set to Distinctive Ring mode. You can not change the Receive Mode from Manual to another mode. | Set Distinctive Ring to Off. (See <i>Turning off the Distinctive Ring</i> on page A-4.) |
| High Temperature | The print head is too warm. | Allow the machine to cool down. |
| Ink Empty | One or more of the ink cartridges is empty. The machine will stop all print operations. While memory is available, black and white faxes will be received into memory. If a sending machine has a color fax, the machine's 'handshake' will request that the fax be sent as black and white. If the sending machine has the ability to convert it, the color fax will be received into memory as a black and white fax. | Replace the ink cartridges. (See <i>Replacing the ink cartridges</i> on page 12-24.) |
| Low Temperature | The print head is too cold. | Allow the machine to warm up. |
| Media Error (MFC-620CN only) | The media card is either corrupted, improperly formatted, or there is a problem with the media card. | Re-insert the card firmly into the slot to make sure it is in the correct position. If the error remains, check the media drive by inserting another media card that you know is working. |
| Near Empty | One or more of the ink cartridges are running out of ink. If a sending machine has a color fax, the machine's 'handshake' will request that the fax be sent as black and white. If the sending machine has the ability to convert it, the color fax will be received into memory as a black and white fax. | Order a new ink cartridge. (See <i>Ordering accessories and supplies</i> on page ii.) |
| No Cartridge | An ink cartridge is not properly installed. | Take out the ink cartridge and put it in again seating it properly. (See <i>Replacing the ink cartridges</i> on page 12-24.) |
| No File (MFC-620CN only) | The media card in the media drive does not contain a .JPG file. | Reinsert the correct media card. |

| ERROR MESSAGES | | |
|------------------|--|---|
| ERROR MESSAGE | CAUSE | ACTION |
| No Paper Fed | The machine is out of paper. | Add paper, and then press Black Start or Color Start . |
| | The paper is jammed in the machine. | See <i>Printer jam or paper jam</i> on page 12-6. |
| No Response/Busy | The number you dialed does not answer or is busy. | Verify the number and try again. |
| Not Registered | You tried to access a One-Touch (FAX-2440C) or Speed-Dial number that is not programmed. | Set up the One-Touch (FAX-2440C) or Speed-Dial number. (See <i>Storing One-Touch Dial numbers (FAX-2440C only)</i> on page 5-1 and <i>Storing Speed-Dial numbers</i> on page 5-2.) |
| Out of Memory | The machine's memory is full. | (Fax sending or copy operation in process) Press Stop/Exit and wait until the other operations in progress finish and then try again. —OR— Clear the data in the memory. To gain extra memory, you can turn off Fax Storage. (See <i>Setting Fax Storage</i> on page 6-3.) —OR— Print the faxes that are in the memory. (See <i>Printing a fax from the memory</i> on page 4-8.) (Printing operation in process) Reduce print resolution. |
| Paper Jam | Paper is jammed in the machine. | (See <i>Printer jam or paper jam</i> on page 12-6.) |
| Wrong Paper Size | Paper is not the correct size. | Reload the correct size of paper (Letter, Legal or A4), and then press Black Start or Color Start . |

ERROR MESSAGES

| ERROR MESSAGE | CAUSE | ACTION |
|--|--|--|
| <p>Unable to Change</p> <p>Unable to Clean</p> <p>Unable to Init.</p> <p>Unable to Print</p> <p>Unable to Scan</p> | <p>The machine has a mechanical problem.</p> <p>—OR—</p> <p>A foreign obstacle, such as a clip or ripped paper, is in the machine.</p> | <p>Open the scanner cover and remove any foreign obstacles from inside the machine. If the error message continues, disconnect the machine from the power for several minutes then reconnect it. The machine's memory will hold faxes for several hours, so you will not lose any important messages. If the error message continues after the machine was disconnected, please follow the procedure below to transfer the faxes to another fax machine.</p> <p>Check whether the machine has faxes in memory</p> <ol style="list-style-type: none"> 1. Press Menu/Set, 9, 0, 1. 2. If the machine has no faxes, disconnect the machine from the power source for several minutes and then reconnect it. <p>—OR—</p> <p>If faxes are present, you can transfer them to another fax machine. Go to Step 3.</p> <p>—OR—</p> <p>For MFC-620CN, you can forward the remaining faxes to your PC. Please see Transfer faxes to your PC.</p> <p>Transfer faxes to another fax machine</p> <p>If you have not set up your Station ID, you cannot enter fax transfer mode.</p> <ol style="list-style-type: none"> 3. Enter the fax number to which faxes will be forwarded. 4. Press Black Start. 5. After faxes are transferred, disconnect the machine from the power source for several minutes and then reconnect it. <p>You can transfer the Fax Journal report to another fax machine by pressing Menu/Set, 9, 0, 2 in Step1.</p> <p>Transfer faxes to your PC (MFC-620CN only)</p> <p>You can move the faxes from your machine's memory to your PC.</p> <ol style="list-style-type: none"> 1. Press Menu/Set, 2, 5, 1. 2. Using ▲ or ▼, select 1. PC Fax Receive, and then press Menu/Set. The LCD will ask if you want to transfer a fax to your PC. 3. To transfer all faxes to your PC, press 1. <p>—OR—</p> <p>To keep all faxes in the machine's memory, press 2.</p> 4. After faxes are transferred, disconnect the machine from the power source for several minutes, and then reconnect it. <p>(For details see <i>Using Brother PC-FAX software</i> on page 5-1 in Software User's Guide on the CD-ROM.)</p> |

Document jams

If the document is jammed, follow the steps below.

Document is jammed in the top of the ADF unit.

- 1 Take out any paper from the ADF that is not jammed.
- 2 Open the ADF cover.
- 3 Pull the jammed document out to the right or left.

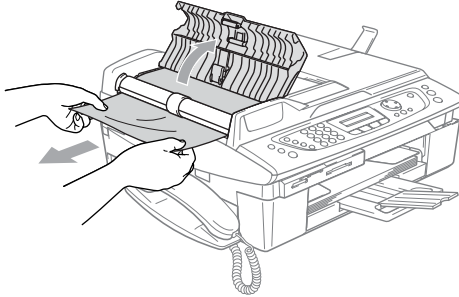

- 4 Close the ADF cover.
Press **Stop/Exit**.

Document is jammed inside the ADF unit.

- 1 Take out any paper from the ADF that is not jammed.
- 2 Lift the document cover.
- 3 Pull the jammed document out to the left.

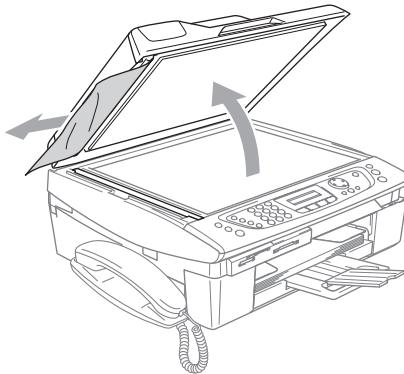

- 4 Close the document cover.
Press **Stop/Exit**.

Printer jam or paper jam

Remove the jammed paper depending on where it is jammed in the machine.

Paper is jammed inside the paper tray

- 1 Pull the paper tray out of the machine.

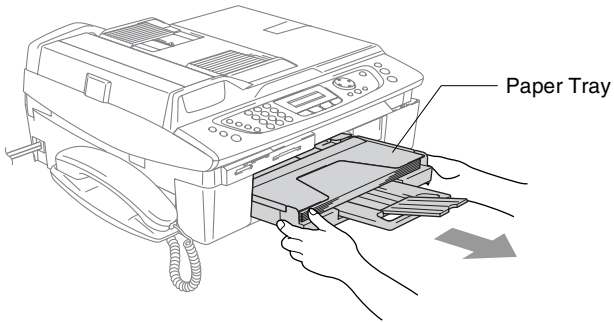

- 2 Pull out the jammed paper to remove it.

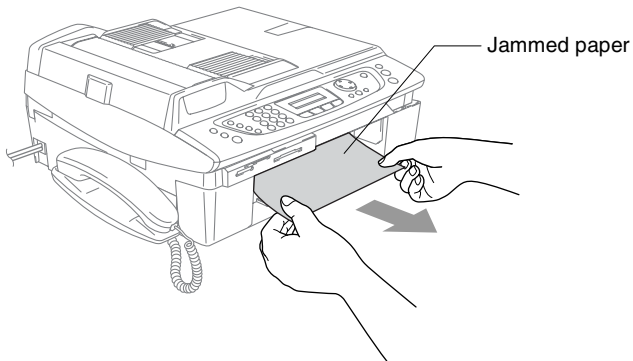

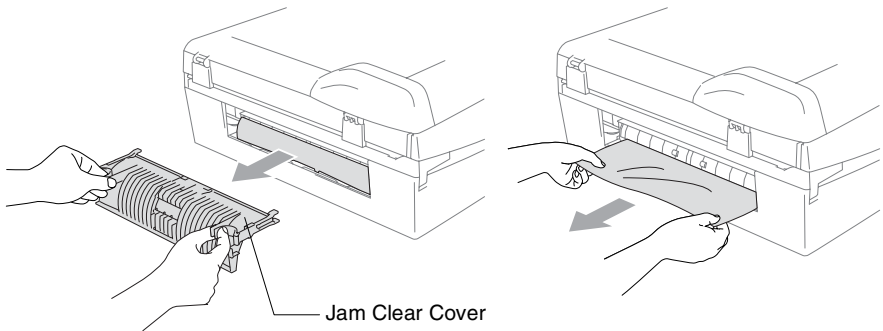

Paper is jammed inside the machine

- 1 Open the jam clear cover. Pull the jammed paper out of the machine.

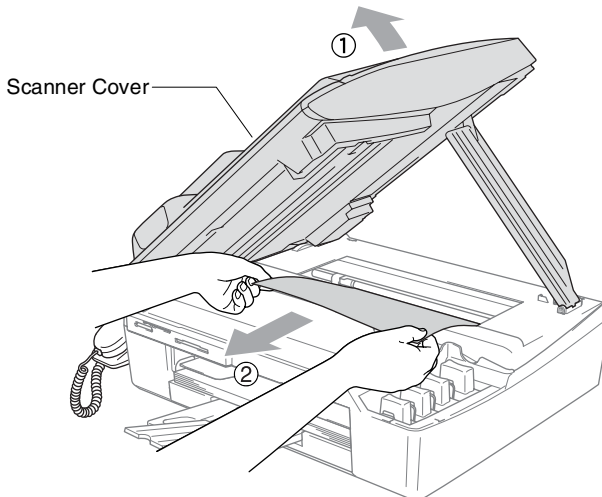

- 2 Close the jam clear cover.
- 3 If you can not pull out the jammed paper, lift the scanner cover from the right-hand side of the machine until it locks securely into the open position.
- 4 Remove the jammed paper.



-  If the paper is jammed underneath the print head, disconnect the machine from the power source so you can move the print head to take out the paper.

- 5** Lift the scanner cover to release the lock. Gently push the scanner cover support down and close the scanner cover.

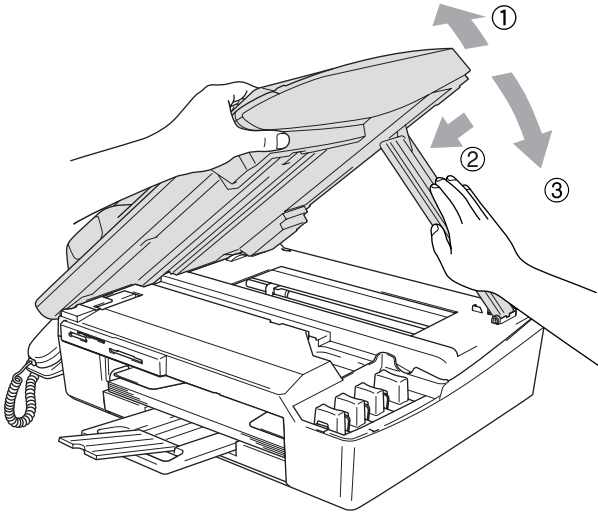

If you are having difficulty with your machine

If you think there is a problem with your machine, check the chart below and follow the troubleshooting tips.

The Brother Solutions Center offers the latest FAQs and troubleshooting tips.

Visit us at <http://solutions.brother.com>.

| DIFFICULTY | SUGGESTIONS |
|--|--|
| Printing | |
| No printout | Check the interface cable connection on both the machine and your computer. |
| | Check the machine is plugged in and On/Off key turned On. |
| | One or more ink cartridges are empty. (See <i>Replacing the ink cartridges</i> on page 12-24.) |
| | Check to see if the LCD is showing an error message. (See <i>Error messages</i> on page 12-1.) |
| Poor quality print. | Check the print quality. (See <i>Checking the print quality</i> on page 12-15.) |
| | Make sure the Printer Driver or Paper Type setting in the menu matches the type of paper you are using. (See <i>Media Type</i> on page 1-8 in Software User's Guide on the CD-ROM and <i>Setting the Paper Type</i> on page 2-4.) |
| | Make sure your ink cartridges are fresh. Cartridges remain fresh for up to two years if kept in their original packaging, after that the ink may become clogged. Cartridge expiration dates are printed on the package. |
| | Try using the recommended types of paper. (See <i>About paper</i> on page 1-10.) |
| | The recommended environment for your machine is between 68°F to 91°F. |
| White horizontal lines appear in text or graphics. | Clean the print head. (See <i>Cleaning the print head</i> on page 12-14.) |
| | Try using the recommended types of paper. (See <i>About paper</i> on page 1-10.) |
| | If horizontal bands appear when using plain paper, use the 'Enhanced Normal Printing' mode to help avoid banding on some types of plain paper. In the printer driver 'Basic' tab, click 'Settings,' and check 'Enhanced Normal Printing.' If you continue to have horizontal bands, change the Media Type selection to 'Slow Drying Paper' in the printer driver 'Basic' tab to help enhance the print quality. |
| The machine prints blank pages. | Clean the print head. (See <i>Cleaning the print head</i> on page 12-14.) |
| Characters and lines are stacked. | Check the printing alignment. (See <i>Checking the printing alignment</i> on page 12-17.) |
| Printed text or images are skewed. | Make sure the paper is loaded properly in the paper tray and the paper side guide is adjusted correctly. (See <i>How to load paper, envelopes and post cards</i> on page 1-15.) |

| DIFFICULTY | SUGGESTIONS |
|---|--|
| Printing (Continued) | |
| Smudged stain at the top center of the printed page. | Make sure the paper is not too thick or not curled. (See <i>About paper</i> on page 1-10.) |
| Printing appears dirty or ink seems to run. | Make sure you are using the proper types of paper. (See <i>About paper</i> on page 1-10.) Don't handle the paper until the ink is dry. |
| Stains appear on the reverse side or at the bottom of the page. | Make sure the Printer Platen is not dirty with ink. (See <i>Cleaning the machine printer platen</i> on page 12-23.) |
| | Make sure you are using the paper support flap. (See <i>How to load paper, envelopes and post cards</i> on page 1-15.) |
| There are some dense lines. | Check 'Reverse Order' in the Basic tab of the printer driver. |
| The printouts are wrinkled. | In the printer driver 'Basic' tab, click the 'Settings', and uncheck the 'Bi-Directional Printing'. |
| Cannot perform '2 in 1 or 4 in 1' printing. | Check that the paper size setting in the application and in the printer driver are the same. |
| Print speed is too slow. | Changing the printer driver setting may improve the print speed. Highest resolution needs longer data processing, transfer and printing time. Try the other settings of quality in the printer driver 'Basic' tab. Also, click the 'Settings' tab, and make sure you uncheck the True2Life®. |
| | Borderless printing is slower than normal printing. If you want to print more quickly, set the Borderless feature off. (See <i>Media Type</i> on page 1-8 in Software User's Guide on the CD-ROM.) |
| True2Life® is not working properly. | If the image data is not full color in your application (Such as 256 color), True2Life® will not work. Please use at least 24 bit color data with the True2Life® feature. |
| Machine feeds multiple pages | Make sure the paper is loaded properly in the paper tray. (See <i>How to load paper, envelopes and post cards</i> on page 1-15.) |
| | Check that more than two types of paper are not loaded in the paper tray at any one time. |
| Printed pages are not stacked neatly. | Make sure you are using the paper support flap. (See <i>How to load paper, envelopes and post cards</i> on page 1-15.) |
| Machine does not print from Paint Brush. | Try setting the Display setting to '256 colors.' |
| Machine does not print from Adobe Illustrator. | Try to reduce the print resolution. |
| Printing Received Faxes | |
| Condensed print and white streaks across the page or the top and bottom of sentences are cut off. | This can be caused by static or interference on the telephone line. You can make a copy using the Black Start key to see if the same problem occurs. If the copy looks good then the problem is probably the phone line and not your machine. |
| Vertical black lines when receiving. | The sender's scanner may be dirty. Ask the sender to make a copy to see if the problem is with the sending machine. Try receiving from another fax machine. |

| DIFFICULTY | SUGGESTIONS |
|--|--|
| Printing Received Faxes (Continued) | |
| Received color fax prints only in black and white. | Replace the color ink cartridges that are empty or nearly empty, and then ask the other person to send the color fax again. (See <i>Replacing the ink cartridges</i> on page 12-24.) Check that Fax Storage is set to OFF. (See <i>Setting Fax Storage</i> on page 6-3.) |
| Left and Right margins are cut off or a single page is printed on two pages. | Turn on Auto Reduction. (See <i>Printing a reduced incoming fax (Auto Reduction)</i> on page 4-7.) |
| Phone Line or Connections | |
| Dialing does not work. (No dial tone) | Check the machine is plugged in. |
| | Check for a dial tone. If possible, call your machine to hear it answer. If there is still no answer, check the telephone line cord connection and make sure all telephone connections are secured. If there is no ringing when you call your machine, ask your telephone company to check the line. |
| | Change Tone/Pulse setting. (See <i>Setting Tone and Pulse dialing mode</i> on page 2-1.) |
| Receiving Faxes | |
| Cannot receive a fax | Make sure the machine is in the correct receiving mode for your setup. (See <i>Basic receiving operations</i> on page 4-1.) |
| | If you frequently encounter interference on the phone line, try changing the menu setting of Compatibility to <i>Basic</i> . (See <i>Compatibility</i> on page 12-13.) |
| Sending Faxes | |
| Cannot send a fax | Make sure that the Fax  key is illuminated. (See <i>How to enter Fax mode</i> on page 3-1.) |
| | Ask the other party to check that receiving machine has paper. |
| | Print the Transmission Verification Report and check for an error. (See <i>Printing reports</i> on page 8-3.) |
| Transmission Verification Report says 'Result:NG' or 'Result:ERROR'. | There is probably temporary noise or static on the line. Try sending the fax again. If you send a PC FAX message and get 'Result:NG' on the Transmission Verification Report, your machine may be out of memory. |
| | If you frequently get transmission error with possible interference on the phone line, try to change the menu setting of Compatibility to <i>Basic</i> . (See <i>Compatibility</i> on page 12-13.) |
| Poor sending quality. | Try changing your resolution to <i>Fine</i> or <i>S.Fine</i> . Make a copy to check your machine's scanner operation. |
| Vertical black lines when sending. | If the copy you made shows the same problem, your scanner is dirty. (See <i>Cleaning the scanner</i> on page 12-22.) |

| DIFFICULTY | SUGGESTIONS |
|---|---|
| Handling Incoming Calls | |
| The machine 'Hears' Voice as CNG Tone. | If your machine is set to Easy Receive ON, it is more sensitive to sounds. Your machine may mistakenly interpret certain voices or music on the line as a calling fax machine and respond with fax receiving tones. Deactivate the fax by pressing Stop/Exit . Try avoiding this problem by turning Easy Receive to Off. (See on page 4-5.) |
| Transferring a Fax Call to the machine. | If you answered at the machine, press Black Start and hang up immediately. If you answered on an extension phone, press your Fax Receive Code (default setting is (✕) 51). When your machine answers, hang up. |
| Custom features on a single line. | If you have Call Waiting, Call Waiting/Caller ID, Ring Master, Voice Mail, an alarm system or any other custom feature on a single phone line with your machine, it may create a problem sending or receiving faxes. For example: If you are sending or receiving a fax message while a custom feature signal comes through on the line, the signal can temporarily interrupt or disrupt the faxes. Brother's ECM feature should help overcome this problem. This condition is related to the telephone system industry and is common to all devices that send and receive data on a single, shared line with custom features. If avoiding a slight interruption is crucial to your business, we recommend a separate phone line with no custom features. |
| Copying Difficulties | |
| Cannot make a copy | Make sure that the Copy  key is illuminated. (See <i>Enter Copy mode</i> on page 9-1.) |
| Vertical streaks appear in copies | Sometimes you may see vertical streaks on copies. Clean the scanner. (See <i>Cleaning the scanner</i> on page 12-22.) |
| Poor copy results | Try using the scanner glass. (See <i>Using the scanner glass</i> on page 1-9.) |
| Scanning Difficulties (MFC-620CN only) | |
| TWAIN/WIA errors appear while scanning. | Make sure the Brother TWAIN/WIA driver is selected as the primary source. In PaperPort®, click Scan in the File menu and select the Brother TWAIN/WIA driver. |
| Poor scanning results | Try using the scanner glass. (See <i>Using the scanner glass</i> on page 1-9.) |
| Software Difficulties (MFC-620CN only) | |
| Cannot install software or print | Run the MFL-Pro Suite Repair and Install program on the CD-ROM. This program will repair and reinstall the software. |
| 'Device Busy' | Make sure the machine is not showing an error message on the LCD. |
| 'Connect Failure' | If the machine is not connected to your PC and you have loaded the Brother software, the PC will show 'MFC Connect Failure' each time you restart Windows®. You can ignore this message or you can turn it off as follows. Double-click "\\tool\warnOff.REG" from the supplied CD-ROM. To turn it back on, double-click "\\tool\WarnOn.REG" from the supplied CD-ROM. The Scan key on the machine's control panel will not work unless you restart your PC with the machine connected. |

| DIFFICULTY | SUGGESTIONS |
|---|---|
| PhotoCapture Center™ Difficulties (MFC-620CN only) | |
| Removable Disk does not work properly. | a) Have you installed the Windows® 2000 update? If not, do the following: <ol style="list-style-type: none"> 1. Disconnect the USB cable. 2. Install the Windows® 2000 update. Please see the Quick Setup Guide. After the installation the PC will be automatically restarted. 3. Wait about 1 minute after you reboot the PC, and then connect the USB cable. b) Take out the media card and put it back in again. c) If you have tried "Eject" from within Windows®, you must take out the media card before you continue. d) If an error message appears when you try to eject the media card, it means the card is being accessed. Wait a while and then try again. e) If all of the above do not work, please turn off your PC and machine, and then turn them on again. (You will have to unplug the power cord of the machine to turn it off.) |
| Cannot access Removable Disk from Desktop icon. | Make sure you have inserted the media card into the media slot. |
| Network Difficulties (MFC-620CN only) | |
| I cannot print over the Network | Make sure that your machine is powered on and is On Line and in Ready mode. Print Network Configuration list. (See <i>Printing reports</i> on page 8-1.) Then the current settings of the network are printed. Reconnect the LAN cable to the hub to verify that the cabling and network connections are good. If possible, try connecting the machine to a different port on your hub using a different cable. If the connections are good, the machine shows LAN Active for 2 seconds. |

Compatibility

If you are having difficulty sending or receiving a fax due to possible interference on the phone line, we recommend that you adjust the Equalization for compatibility with your phone line. The machine adjusts the modem speed for fax operations.

1 Press **Menu/Set**, **2**, **0**, **1**.

2 Press **▲** or **▼** to select **Normal** (or **Basic**).

Press **Menu/Set**.

3 Press **Stop/Exit**.



■ **Basic** reduces the modem speed to 9600 bps. Unless interference is a recurring problem on your phone line, you may prefer to use it only when needed.

■ **Normal** sets the modem speed at 14400 bps. (Default)

Miscellaneous
 1. Compatibility

How to improve print quality

Cleaning the print head

To ensure good print quality, the machine will regularly clean the print head. You can start the cleaning process manually if needed.

Clean the print head and ink cartridges if you get a horizontal line in the text or graphics on your printed pages. You can clean Black only or three colors at a time (Cyan/Yellow/Magenta), or all four colors at once.

Cleaning the print head consumes ink. Cleaning too often uses ink unnecessarily.

Caution

Do NOT touch the print head. Touching the print head may cause permanent damage and may void the print head's warranty.

- 1** Press **Ink**.
- 2** Press **▲** or **▼** to select **Cleaning**.
Press **Menu/Set**.
- 3** Press **▲** or **▼** to select **Black, Color** or **All**.
Press **Menu/Set**.

The machine will clean the print head. When cleaning is finished, the machine will go back to standby mode automatically.



If you clean the print head at least five times and the print has not improved, call Brother Customer Service (see *Brother numbers* on page i).

Checking the print quality

If faded or streaked colors and text appears on your output, some of the nozzles may be clogged. You can check this by printing the Print Quality Check Sheet and looking at the nozzle check pattern.

- 1** Press **Ink**.
- 2** Press **▲** or **▼** to select `Test Print`.
Press **Menu/Set**.
- 3** Press **▲** or **▼** to select `Print Quality`.
Press **Menu/Set**.
- 4** Press **Color Start**.

The machine begins printing the Print Quality Check Sheet.

- 5** Check the sheet to see if the quality is OK by following these steps.

Color block quality check

The LCD shows:

Is Quality OK?
1.Yes 2.No

- 6** Check the quality of the four color blocks on the sheet.
- 7** If all lines are clear and visible, press **1** (Yes), and go to Step 10.
—OR—

If you can see missing short lines as shown below, press **2** (No).

OK

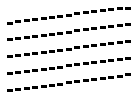

Poor

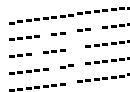

The LCD will ask you if the print quality is OK for black and three colors.

Black OK?
1.Yes 2.No

- 8** Press **2** (No) for Black or three colors with a problem.

The LCD shows:

Start Cleaning?
1.Yes 2.No

Press **1** (Yes).

The machine will start cleaning the print head.

- 9** After cleaning is finished, press **Color Start**. The machine will start printing the Print Quality Check Sheet again and then return to Step 5.

- 10** Press **Stop/Exit**.

If you still see missing ink in this Print Quality Check Sheet, repeat the cleaning and test print procedures at least five times. If ink is still missing after the fifth cleaning and test print, replace the ink cartridge for the clogged color. (Perhaps the ink cartridge was in your machine over six months or the expiration date written on the cartridge package has passed. Or, the ink may not have been stored properly before use.)

After replacing the ink cartridge, check it by printing another Print Quality Check Sheet. If the problem still exists, repeat the cleaning and test print procedures at least five times for the new ink cartridge. If ink is still missing, call Brother Customer Service (see *Brother numbers* on page i).

! Caution

Do NOT touch the print head. Touching the print head may cause permanent damage and may void the print head's warranty.



When a print head nozzle is clogged the printed sample looks like this.



After the print head nozzle is cleaned, the horizontal lines are gone.

Checking the printing alignment

You should rarely need to adjust the printing alignment however, if after transporting the machine your printed text becomes blurred or images become faded then adjustment may need to be made.

- 1** Press **Ink**.
- 2** Press **▲** or **▼** to select `Test Print`.
Press **Menu/Set**.
- 3** Press **▲** or **▼** to select `Alignment`.
Press **Menu/Set**.
- 4** Press **Black Start** or **Color Start**.

The machine begins printing the Alignment Check Sheet.

The LCD shows:

Is Alignment OK?
1.Yes 2.No

- 5** Check the 600 dpi and 1200 dpi test prints to see if number 5 most closely matches number 0. If the number 5 sample of both the 600 dpi and 1200 dpi are the best matches, press **1** (Yes) to finish Alignment Check, and go to Step 8.

—OR—

If another test print number is a better match for either 600 dpi or 1200 dpi, press **2** (No) to select it.

- 6** For 600 dpi, press the number of the test print that most closely matches the number 0 sample (1-8).
- 7** For 1200 dpi, press the number of the test print that most closely matches the number 0 sample (1-8).
- 8** Press **Stop/Exit**.

600dpi Adjust
Select Best # 5

1200dpi Adjust
Select Best # 5

Checking the ink volume

You can check the ink that is left in the cartridge.

- 1 Press **Ink**.
- 2 Press **▲** or **▼** to select **Ink Volume**.
Press **Menu/Set**.

- 3 Press **▲** or **▼** to select the color you want to check.

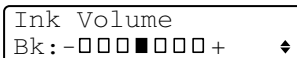

The LCD shows the ink volume.

- 4 Press **Stop/Exit**.



(MFC-620CN only) You can check the ink volume from your computer. (See *MFC Remote Setup (not available for MFC-210C)* on page 4-1 in Software User's Guide on the CD-ROM or *MFC Remote Setup (Mac OS® X 10.2.4 or greater) (not available for MFC-210C)* on page 8-43 in Software User's Guide on the CD-ROM.)

Packing and shipping the machine

Whenever you transport the machine, use the packing materials that came with your machine. If you do not pack the machine properly, you could void your warranty.

! Caution

It is important to allow the machine to 'park' the print head after a print job. Listen carefully to the machine before disconnecting it from the power source to ensure that all mechanical noise has stopped. Not allowing the machine to complete this parking process may lead to print problems and possible damage to the print head.

- 1 Lift the scanner cover from the right-hand side of the machine until it locks securely into the open position.
- 2 Remove all the ink cartridges and attach the protective parts. (See *Replacing the ink cartridges* on page 12-24.)

When attaching the protective parts, make sure it clips into place as shown in the diagram.

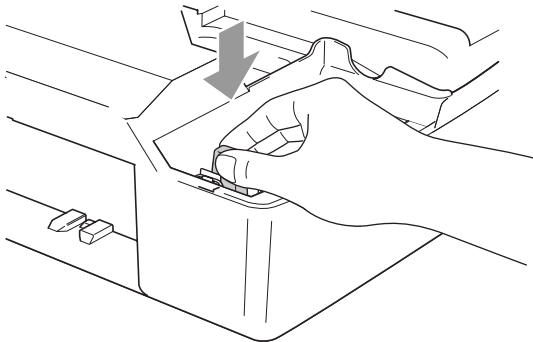

! Caution

If you are not able to find the protective parts, do NOT remove the ink cartridges before shipping. It is essential that the machine be shipped with either the protective parts or the ink cartridges in position. Shipping without them will cause damage to your machine and may void your warranty.

- 3** Lift the scanner cover to release the lock. Gently push the scanner cover support down and close the scanner cover.

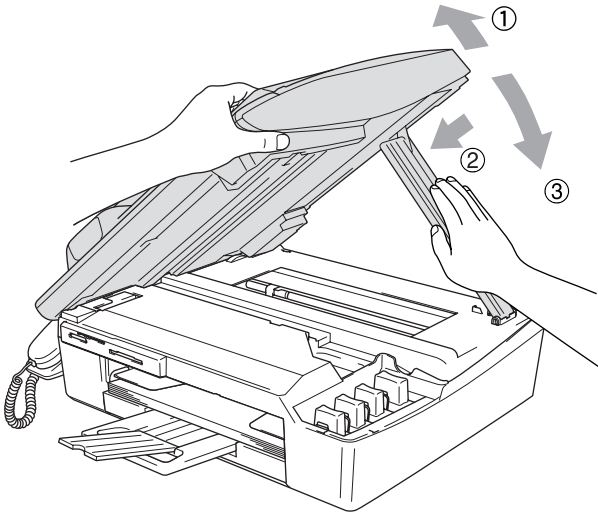

- 4** Unplug the machine from the telephone wall jack and remove the telephone line cord from machine.
- 5** Unplug the machine from the AC power outlet.
- 6** Unplug the USB cable or LAN cable from the machine, if it is connected.
- 7** If your machine has a handset, remove it and the handset curled cord.
-  If you are packing the machine for the Brother Exchange Service, keep these items and return only the machine.
- 8** Wrap the machine in the bag and place it in the original carton with the original packing material.

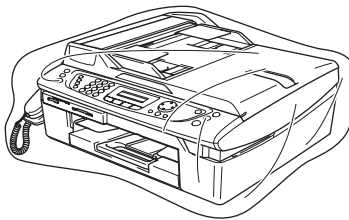

- 9** Pack the printed materials in the original carton as shown below. Do not pack the used ink cartridges in the carton.

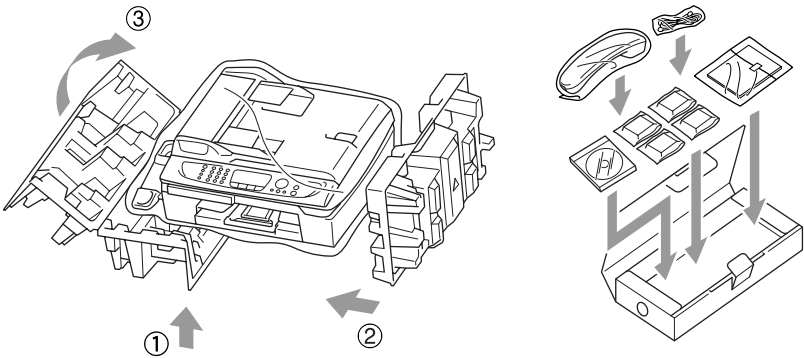

-  If you are returning your machine to Brother as part of the Exchange Service, pack *only* the machine. Keep all separate parts and printed materials to use with your “Exchange” machine.

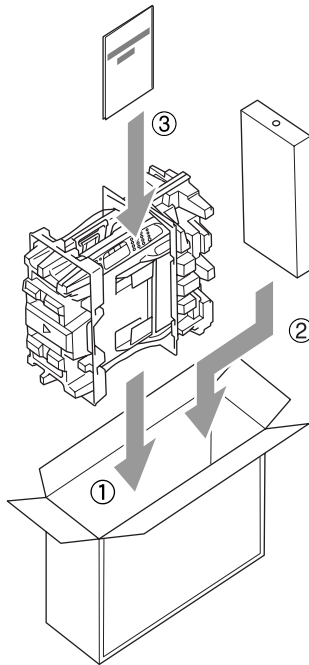

- 10** Close the carton.

Routine maintenance

Cleaning the scanner

Unplug the machine and lift the document cover. Clean the scanner glass with isopropyl alcohol on a soft lint-free cloth.

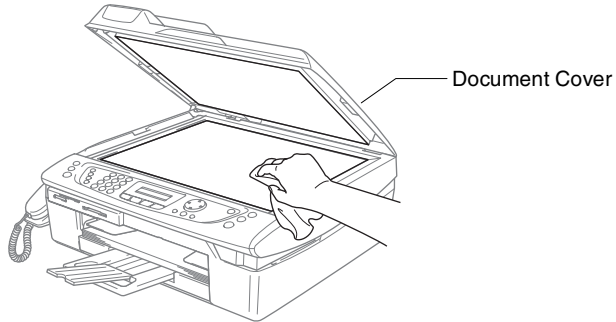

Clean the white bar and the glass strip under the film with isopropyl alcohol on a lint-free cloth.

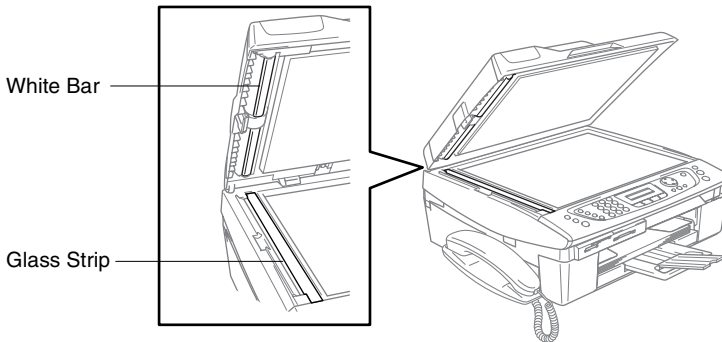

Cleaning the machine printer platen

- Be careful not to touch the paper feed star wheels or encoder film.
- Be sure to unplug the machine from the AC power outlet before cleaning the printer platen.
- If ink is scattered on or around the printer platen be sure to wipe it off with a soft, dry, lint-free cloth.

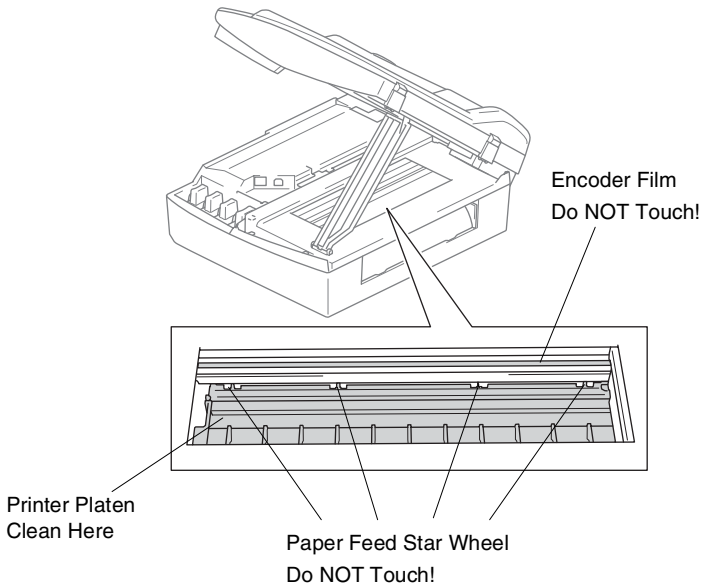

Replacing the ink cartridges

Your machine is equipped with an ink dot counter. The ink dot counter automatically monitors the level of ink in each of the 4 cartridges. When the machine detects an ink cartridge is running out of ink, the machine will notify you with a message on the LCD.

The LCD will inform you which ink cartridge is low or needs replacing. Be sure to follow the LCD prompts to replace the ink cartridges in the correct order.

Even though the machine informs you that an ink cartridge is empty, there will be a small amount of ink remaining in the ink cartridge. It is necessary to keep some ink in the ink cartridge to prevent air from drying out and damaging the print head assembly.

- 1** Lift the scanner cover from the right-hand side of the machine until it locks securely into the open position.

If one or more ink cartridges are empty, for example Black, the LCD shows `Ink Empty Black and Cover is Open`.

- 2** Pull the ink cartridge hook toward you and remove the ink cartridge for the color shown on the LCD.

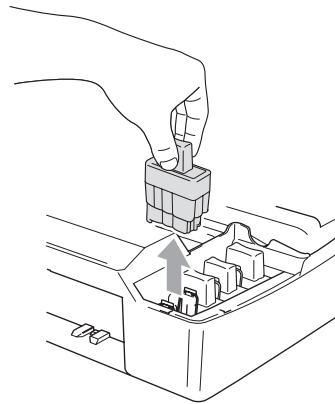
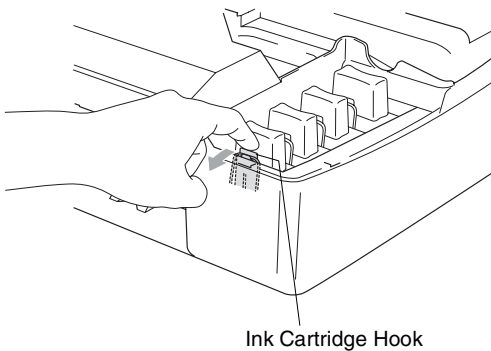

- 3** Open the new ink cartridge bag for the color shown on the LCD, and then take out the ink cartridge.

4 Remove the cartridge covers.

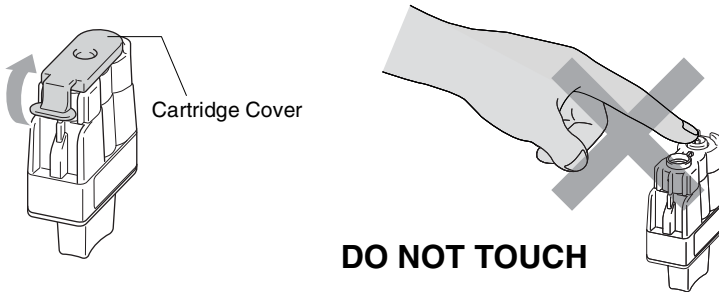

⊘ Do not touch the area shown in the illustration above.

 If the cartridge cover comes off when you open the bag the cartridge will not be damaged.

5 Each color has its own correct position. Keep the ink cartridge in an upright position when you insert it into slot. Press down on the ink cartridge until the hook snaps over it.

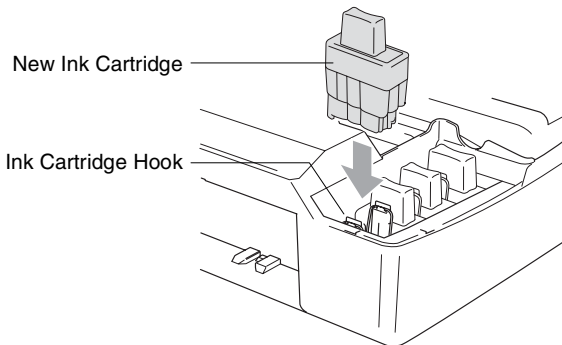

6 Lift the scanner cover to release the lock. Gently push the scanner cover support down and close the scanner cover.

7 If you replaced an ink cartridge while `Near Empty` was displayed on the LCD, the LCD may ask you to verify that it was a brand new one. Example: `Did You Change Blck? 1.Yes 2.No`. For each *new* cartridge you installed, press **1** on the dial pad to automatically reset the ink dot counter for that color. If the ink cartridge you installed is not a brand new one, please be sure to select **2**.



If you wait until `Ink Empty` message is displayed on the LCD, the machine will automatically reset the ink dot counter.



If the `Install` message is on the display after you have installed ink cartridges, check that the ink cartridges are installed properly.



WARNING

If ink gets in your eyes, irrigate them with water immediately and call a doctor if you are concerned.

 **Caution**

- Do not remove ink cartridges if you do not need to replace them. If you do so, it may reduce the ink quantity and the machine will not know the quantity of ink left in the cartridge.
- Do not touch the cartridge insertion slots. If you do so, the ink may stain your skin.
- If ink stains your skin or clothing, wash with soap or detergent immediately.
- If you install an ink cartridge in the wrong color position, you must clean the print head several times before you start printing (after correcting the cartridge installation) because the colors were mixed.
- Once you open an ink cartridge, install it in the machine and use it up within six months of installation. Use unopened ink cartridges by the expiration date written on the cartridge package.
- Do not dismantle or tamper with the ink cartridge, this can cause the ink to leak out of the cartridge.
- Brother strongly recommends that you do not refill the ink cartridges provided with your machine. We also strongly recommend that you continue to use only Genuine Brother Brand replacement ink cartridges. Using or attempting to use potentially incompatible inks and/or cartridges in your machine may cause damage to the machine itself and/or it may result in unsatisfactory print quality. Our warranty coverage does not apply to any problem that was caused by the use of unauthorized third party ink and/or cartridges. To protect your investment and guarantee your print quality please continue to replace consumed ink cartridges with only Genuine Brother Branded Supplies.

A Appendix A

Setting up telephone services

Your machine supports the Caller ID and Distinctive Ring subscriber telephone services that some telephone companies offer.



If you have Voice Mail, Call Waiting, Call Waiting/Caller ID, RingMaster, an answering service, an alarm system or other custom features on your telephone line, it may affect the way your machine works. (See *Custom features* on page 1-19 and *Custom features on a single line.* on page 12-12.)

If you have Voice Mail on your phone line, please read the following carefully.

Distinctive Ring

Brother uses the term 'Distinctive Ring' but different telephone companies have other names for this service such as SmartRing, RingMaster, Teen-Ring, Indent-a-Call or Indent-a-Ring.

What does your telephone company's 'Distinctive Ring' do?

Your telephone company's Distinctive Ring service allows you to have more than one number on the same phone line. **If you need more than one phone number, it is cheaper than paying for an extra line.** Each phone number has its own distinctive ring pattern, so you will know which phone number is ringing. This is one way you can have a separate phone number for your machine.



Please call your telephone company for availability and rates.

What does Brother's 'Distinctive Ring' do?

The Brother machine has a Distinctive Ring feature that allows you to use your machine to take full advantage of the telephone company's Distinctive Ring service. The new phone number on your line can just receive faxes.



You must pay for your telephone company's Distinctive Ring service before you program the machine to work with it.

Do you have Voice Mail?

If you have Voice Mail on the phone line that you will install your new machine on, *there is a strong possibility that Voice Mail and the machine will conflict with each other while receiving incoming calls.* **However, the Distinctive Ring feature allows you to use more than one number on your line, so both Voice Mail and the machine can work together without any problems.** If each one has a separate phone number, neither will interfere with the other's operations.





If you decide to get the Distinctive Ring service from the telephone company, you will need to follow the directions below to 'register' the new Distinctive Ring pattern they give you. This is so your machine can recognize its incoming calls.



You can change or cancel the Distinctive Ring pattern at any time. You can switch it off temporarily, and turn it back on later. When you get a new fax number, make sure you reset this feature.

Before you choose the ring pattern to register

You can only register one Distinctive Ring pattern with the machine. Some ring patterns cannot be registered. The ring patterns below are supported by your Brother machine. Register the one your telephone company gives you.

| Ring Pattern | Rings | |
|--------------|----------------------------|---|
| 1 | long-long |  |
| 2 | short-long-short |  |
| 3 | short-short-long |  |
| 4 | very long (normal pattern) |  |



If the ring pattern you received is not on this chart, **please call your telephone company and ask for one that is shown.**

- The machine will only answer calls to its registered number.
- The first two rings are silent on the machine. This is because the fax must «listen» to the ring pattern (to compare it to the pattern that was 'registered'). (Other telephones on the same line will ring.)
- If you program the machine properly, it will recognize the registered ring pattern of the 'fax number' within 2 ring patterns and then answer with a fax tone. When the 'voice number' is called, the machine will not answer.

Registering the Distinctive Ring pattern

Very important!

After you have set the Distinctive Ring feature to ON, the receive mode is set to `Manual` automatically. Unless you have a TAD or Voice Mail set up on the Distinctive Ring number, `Manual` mode means you must answer all the calls yourself. You can not change the receive mode to another mode while the Distinctive Ring is set to on.

- 1 Press **Menu/Set**, **2, 0, 2**.
- 2 Press **▲** or **▼** to select `Set`.

| |
|--------------------------------|
| Miscellaneous 2.Distinctive |
|--------------------------------|

- 3 Press **▲** or **▼** to select the stored ring pattern you want to use.
Press **Menu/Set**.

(You will hear each pattern as you scroll through the four patterns. Make sure you choose the pattern that the telephone company gave you.)

- 4 Press **Stop/Exit**. Distinctive Ring is now set to on.

Turning off the Distinctive Ring

- 1 Press **Menu/Set**, **2, 0, 2**.
- 2 Press **▲** or **▼** to select `Off`.

| |
|--------------------------------|
| Miscellaneous 2.Distinctive |
|--------------------------------|

- 3 Press **Stop/Exit**.

 If you turn off Distinctive Ring, the machine will stay in `Manual` receive mode. You will need to set the Receive Mode again. (See *To select or change your Receive Mode* on page 4-2.)

Caller ID



The Caller ID feature lets you use the Caller ID subscriber service offered by many local telephone companies. This service displays the telephone number, or name if it is available, of your caller as the line rings.

After a few rings, the LCD shows the telephone number of your caller (and name, if available). Once you pick up the handset, the Caller ID information disappears from the LCD, but the call information remains stored in the Caller ID memory.

- You will see the first 16 characters of the number (or name).
- `Out of Area` display means call originated outside your Caller ID service area.
- `Private Call` display means the caller has intentionally blocked transmission of information.

You can print a list of Caller ID information received by your machine. (See *Printing Caller ID List* on page A-6.)

Caller ID service varies with different carriers. Call your local telephone company to determine the kind of service available in your area.

Viewing Caller ID List

Caller ID memory stores information for up to thirty calls. When the thirty-first call comes in, information about the first call is erased. You can scroll through Caller ID information to review those calls made to your machine.

- 1 Press **Menu/Set**, **2**, **0**, **3**.
- 2 Press **▲** or **▼** to select `Display#`.
Press **Menu/Set**.

| |
|------------------------------|
| Miscellaneous 3.Caller ID |
|------------------------------|

If the name was not received, it will not be displayed.

- 3 Press **▲** or **▼** to scroll through the Caller ID memory to select the Caller ID you want to view, and then press **Menu/Set**. The LCD shows the caller's name or number and the date and time of the call.
- 4 Press **◀** to return to the Caller ID listing.
—OR—
Press **Stop/Exit**.

Printing Caller ID List

- 1 Press **Menu/Set**, **2**, **0**, **3**.
- 2 Press **▲** or **▼** to select `Print Report`.
Press **Menu/Set**.
- 3 Press **Black Start** or **Color Start**.
- 4 After printing has finished, press **Stop/Exit**.

| |
|------------------------------|
| Miscellaneous 3.Caller ID |
|------------------------------|

Advanced receiving operations

Operation from extension telephones

If you answer a fax call on an extension telephone, or an external telephone in the EXT. jack of the machine, you can make your machine take the call by using the Fax Receive Code. When you press the Fax Receive Code *51, the machine starts to receive a fax. (See *Easy Receive* on page 4-6.)

If the machine answers a voice call and pseudo/double-rings for you to take over, use the Telephone Answer Code #51 to take the call at an extension phone. (See *Setting the F/T Ring Time (Fax/Tel mode only)* on page 4-5.)

If you answer a call and no one is on the line, you should assume that you're receiving a manual fax.

- Press *51 and wait for the chirp or until the machine's LCD displays *Receiving*, and then hang up.

Your caller will have to press **Start** to send the fax.

For Fax/Tel mode when power key is On

When the machine is in Fax/Tel mode, it will use the F/T Ring Time (pseudo/double-ringing) to alert you to pick up a voice call.

If you're at the machine, you can lift the handset or press **Speaker Phone** to answer. If you're at an extension phone, you'll need to lift the handset during the F/T Ring Time and then press **#51** between the pseudo/double rings. If no one is on the line, or if someone wants to send you a fax, send the call back to the machine by pressing * **51**.

Fax/Tel mode when power key is Off

You can change the default setting of the **On/Off** key to Fax Receive:On so that you can receive faxes when the power key is off. (See *On/Off Setting* on page 1-6.) Fax/Tel mode will work in the following ways.

When the machine is in Fax/Tel mode and pseudo/double-rings to alert you to pick up a voice call, you can only answer by picking up the machine's handset.

If you answer *before* the machine answers with pseudo/double-ringing, you can pick up the call at an external or extension phone.

Using a cordless external handset

If your cordless telephone is connected to the EXT. jack on the machine and you typically carry the cordless handset elsewhere, it is easier to answer calls during the Ring Delay.

Changing the remote codes

Remote Codes might not work with some telephone systems. The preset Fax Receive Code is *51. The preset Telephone Answer Code is #51.



If you are always disconnected when accessing your external TAD remotely, try changing the Fax Receive Code and Telephone Answer Code to another three-digit code (such as ### and 999).

1 If it is not illuminated in green, press  (Fax).

2 Press **Menu/Set**, **2**, **1**, **4**.

3 Press **▲** or **▼** to select On (or Off).

Press **Menu/Set**.

4 Enter the new Fax Receive Code.

Press **Menu/Set**.

5 Enter the new Telephone Answer Code.

Press **Menu/Set**.

6 Press **Stop/Exit**.



Setup Receive
4.Remote Code

Connecting an external device to your machine

Connecting an external telephone

You can connect a separate telephone (or telephone answering device) directly to your machine as shown in the diagram below.

Connect the telephone line cord to the jack labeled EXT. in the left of the machine.

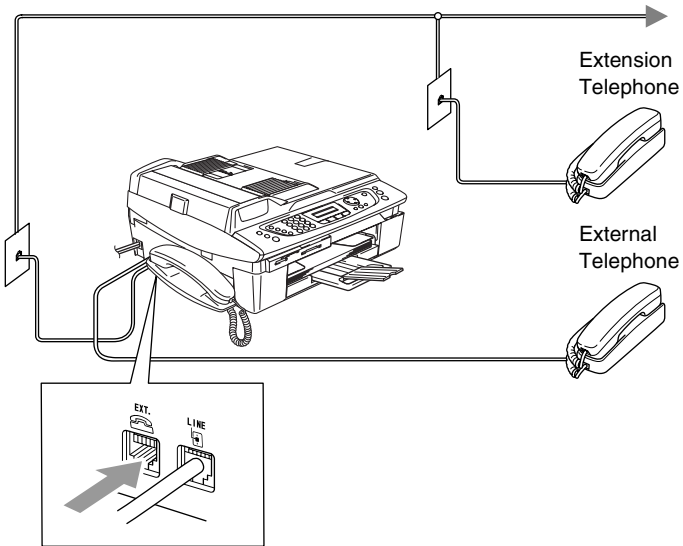

When you are using a TAD, the LCD shows `Ext. Tel in Use.`

Connecting an external telephone answering device (TAD)

Sequence

You may choose to connect an additional answering device. However, when you have an **external** TAD on the same telephone line as the machine, the TAD answers all calls and the machine “listens” for fax calling (CNG) tones. If it hears them, the machine takes over the call and receives the fax. If it does not hear CNG tones, the machine lets the TAD continue playing your outgoing message so your caller can leave you a voice message.

The TAD must answer within four rings (the recommended setting is two rings). The machine cannot hear CNG tones until the TAD has answered the call, and with four rings there are only 8 to 10 seconds of CNG tones left for the fax “handshake”. Make sure you carefully follow the instructions in this guide for recording your outgoing message. We do not recommend using the toll saver feature on your external answering machine if it exceeds five rings.



If you do not receive all your faxes, reduce the Ring Delay setting on your external TAD.



If You Subscribe to your Telephone Company’s Distinctive Ring Service:

You may connect an external TAD to a separate wall jack only if you subscribe to your telephone company’s Distinctive Ring service, have registered the distinctive ring pattern on your machine, and use that number as a fax number. The recommended setting is at least four rings on the external TAD when you have the telephone company’s Distinctive Ring Service. You cannot use the Toll Saver setting.



If You Do Not Subscribe to Distinctive Ring Service:

You must plug your TAD into the EXT. jack of your machine. If your TAD is plugged into a wall jack, both your machine and the TAD will try to control the phone line. (See illustration below.)



Unless you are using Distinctive Ring, do not connect a TAD elsewhere on the same phone line.

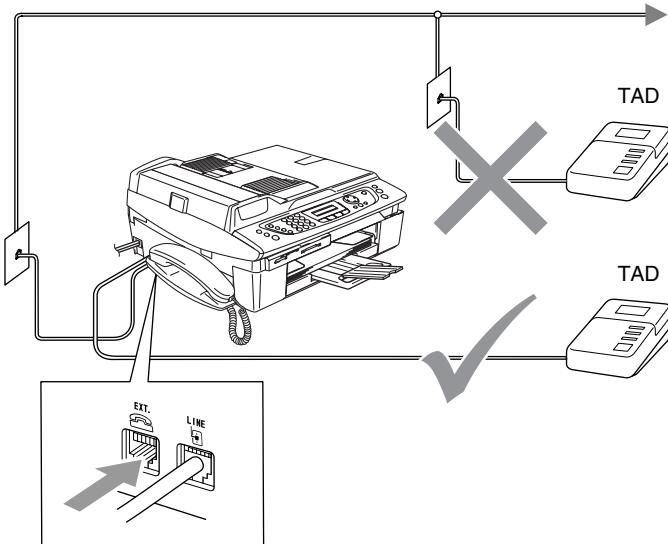

When you are using a TAD, the LCD shows `Ext. Tel in Use.`

Connections

The external TAD must be plugged into the back of the machine, into the jack labeled EXT. Your machine cannot work properly if you plug the TAD into a wall jack (unless you are using Distinctive Ring).

- 1** Plug the telephone line cord from the telephone wall jack into the back of the machine, in the jack labeled LINE.
- 2** Plug the telephone line cord from your external TAD into the back of the machine, in the jack labeled EXT. (Make sure this cord is connected to the TAD at the TAD's telephone *line* jack, and not its telephone jack.)
- 3** Set your external TAD to four rings or less. (The machine's Ring Delay setting does not apply.)
- 4** Record the outgoing message on your external TAD.
- 5** Set the TAD to answer calls.
- 6** Set the Receive Mode to *Manual*.
(See *Choosing the Receive Mode* on page 4-1.)

Recording outgoing message (OGM) on an external TAD

Timing is important in recording this message. The message sets up the ways to handle both manual and automatic fax reception.

- 1** Record 5 seconds of silence at the beginning of your message. (This allows your machine time to listen for the fax CNG tones of automatic transmissions before they stop.)
- 2** Limit your speaking to 20 seconds.
- 3** End your 20-second message by giving your Fax Receive Code for people sending manual faxes. For example:
*"After the beep, leave a message or send a fax by pressing * 51 and Start."*



We recommend beginning your OGM with an initial 5-second silence because the machine cannot hear fax tones over a resonant or loud voice. You may try omitting this pause, but if your machine has trouble receiving, then you must re-record the OGM to include it.

Special line considerations

Roll over phone lines

A roll over phone system is a group of two or more separate telephone lines that pass incoming calls to each other if they are busy. The calls are usually passed down or “rolled over” to the next available phone line in a preset order.

Your machine can work in a roll over system as long as it is the last number in the sequence, so the call cannot roll away. Do not put the machine on any of the other numbers; when the other lines are busy and a second fax call is received, the fax call would be transferred to a line that does not have a fax machine. **Your machine will work best on a dedicated line.**

Two-line phone system

A two-line phone system is nothing more than two separate phone numbers on the same wall outlet. The two phone numbers can be on separate jacks (RJ11) or combined into one jack (RJ14). Your machine must be plugged into an RJ11 jack. RJ11 and RJ14 jacks may be equal in size and appearance and both may contain four wires (black, red, green, yellow). To test the type of jack, plug in a two-line phone and see if it can access both lines. If it can, you must separate the line for your machine. (See on page 4-5.)

Converting telephone wall outlets

There are three ways to convert to an RJ11 jack. The first two ways may require assistance from the telephone company. You can change the wall outlets from one RJ14 jack to two RJ11 jacks. Or, you can have an RJ11 wall outlet installed and slave or jump one of the phone numbers to it.

The third way is the easiest: Buy a triplex adapter. You can plug a triplex adapter into an RJ14 outlet. It separates the wires into two separate RJ11 jacks (Line 1, Line 2) and a third RJ14 jack (Lines 1 and 2). If your machine is on Line 1, plug the machine into L1 of the triplex adapter. If your machine is on Line 2, plug it into L2 of the triple adapter.

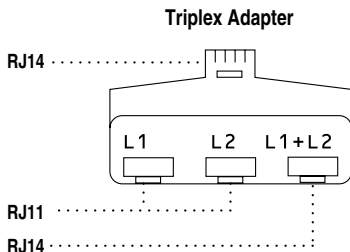

Installing machine, external two-line TAD and two-line telephone

When you are installing an external two-line telephone answering device (TAD) and a two-line telephone, your machine must be isolated on one line at both the wall jack and at the TAD. The most common connection is to put the machine on Line 2, which is explained in the following steps. The back of the two-line TAD must have two telephone jacks: one labeled L1 or L1/L2, and the other labeled L2. You will need at least three telephone line cords, the one that came with your machine and two for your external two-line TAD. You will need a fourth line cord if you add a two-line telephone.

- 1** Place the two-line TAD and the two-line telephone next to your machine.
- 2** Plug one end of the telephone line cord for your machine into the L2 jack of the triplex adapter. Plug the other end into the LINE jack on the back of the machine.
- 3** Plug one end of the first telephone line cord for your TAD into the L1 jack of the triplex adapter. Plug the other end into the L1 or L1/L2 jack of the two-line TAD.
- 4** Plug one end of the second telephone line cord for your TAD into the L2 jack of the two-line TAD. Plug the other end into the EXT. jack on the left side of the machine.

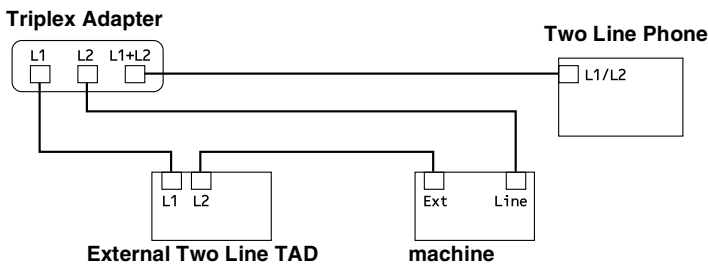

You can keep two-line telephones on other wall outlets as always. There are two ways to add a two-line telephone to the machine's wall outlet. You can plug the telephone line cord from the two-line telephone into the L1+L2 jack of the triplex adapter. Or, you can plug the two-line telephone into the TEL jack of the two-line TAD.

Multi-line connections (PBX)

Most offices use a central telephone system. While it is often relatively simple to connect the machine to a key system or a PBX (Private Branch Exchange), we suggest that you contact the company that installed your telephone system and ask them to connect the machine for you. It is advisable to have a separate line for the machine.

If the machine is to be connected to a multi-line system, ask your installer to connect the unit to the last line on the system. This prevents the unit from being activated each time a telephone call is received.

If you are installing the machine to work with a PBX

- 1** It is not guaranteed that the unit will operate properly under all circumstances with a PBX. Any cases of difficulty should be reported first to the company that handles your PBX.
- 2** If all incoming calls will be answered by a switchboard operator, it is recommended that the Receive Mode be set to *Manual*. All incoming calls should initially be regarded as telephone calls.

Custom features on your phone line

If you have Voice Mail, Call Waiting, Call Waiting/Caller ID, RingMaster, an answering service, an alarm system or other custom feature on one phone line it may create a problem with the operation of your machine. (See *Custom features* on page 1-19 and *Custom features on a single line* on page 12-12.)

B Appendix B

On-screen programming

Your machine is designed to be easy to use with LCD on-screen programming using the navigation keys. User-friendly programming helps you take full advantage of all the menu selections your machine has to offer.

Since your programming is done on the LCD, we have created step-by-step on-screen instructions to help you program your machine. All you need to do is follow the instructions as they guide you through the menu selections and programming options.

Menu table

You can probably program your machine without the User's Guide if you use the Menu table that begins on page B-3. These pages will help you understand the menu selections and options that are found in the machine's programs.



You can program your machine by pressing **Menu/Set**, followed by the menu numbers.

For example to set `Fax Resolution` to `Fine`:





Press **Menu/Set**, **2**, **2**, **2** and **▲** or **▼** to select `Fine`.

Press **Menu/Set**.

Memory storage

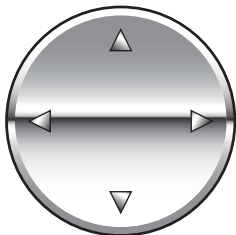
If there is a power failure, you will not lose your menu settings because they are stored permanently. Temporary settings (such as Contrast, Overseas Mode, and so on) will be lost. You may also have to reset the date and time.

Navigation keys

| | | |
|---|--|--|
|  |  Menu/Set | Access the menu Go to the next menu level Accept an option |
| |  | Scroll through the current menu level |
| |  | Go back to the previous menu level |
| |  Stop/Exit | Exit the menu |

You can access the menu mode by pressing **Menu/Set**.
When you enter the menu, the LCD scrolls.

Press **1** for General Setup menu

—OR—

Select ▲▼ & Set
1.General Setup

Press **2** for Fax menu

—OR—

Select ▲▼ & Set
2.Fax

Press **3** for Copy menu

⋮

Select ▲▼ & Set
3.Copy

Press **0** for Initial Setup

Select ▲▼ & Set
0.Initial Setup

You can scroll more quickly through each menu level by pressing the arrow for the direction you want: ▲ or ▼.

Select an option by pressing **Menu/Set** when that option appears on the LCD.

The LCD will then show the next menu level.

Press ▲ or ▼ to scroll to your next menu selection.

Press **Menu/Set**.

When you finish setting an option, the LCD shows *Accepted*.

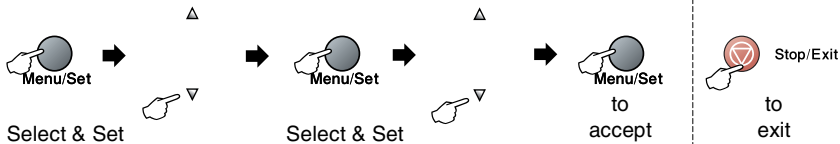

| Main Menu | Submenu | Menu Selections | Options | Descriptions | Page | |
|-----------------|--------------|------------------|---|---|--|-----|
| 1.General Setup | 1.Mode Timer | — | 5 Mins 2 Mins 1 Min 30 Secs 0 Sec Off | Sets the time to return to Fax mode. | 2-3 | |
| | 2.Paper Type | — | Plain Inkjet Glossy Transparency | Sets the type of paper in the paper tray. | 2-4 | |
| | 3.Paper Size | — | Letter Legal A4 A5 4"x6" | Sets the size of the paper in the paper tray. | 2-4 | |
| | 4.Volume | 1.Ring | | High Med Low Off | Adjusts the ring volume. | 2-5 |
| | | 2.Beeper | | High Med Low Off | Adjusts the volume level of the beeper. | 2-5 |
| | | 3.Speaker | | High Med Low Off | Adjusts the speaker volume. | 2-6 |
| | | 4.Handset | | High Low | Adjusts handset volume. | 2-7 |
| | | 5.Volume Amplify | | On (Permanent/ Temporary) Off | For the hearing-impaired, you can set the volume to the Volume Amplify:On setting on a permanent or temporary basis. | 2-9 |

 The factory settings are shown in Bold.

| Main Menu | Submenu | Menu Selections | Options | Descriptions | Page |
|--------------------------------|---------------------------------------|------------------|---|---|------|
| 1.General Setup (Continued) | 5.Auto Daylight | — | On Off | Changes for Daylight Savings Time automatically. | 2-10 |
| | 6.On/Off Setting | — | Fax Receive:On Fax Receive:Off | Customizes the On/Off key to receive faxes even in OFF mode. | 2-10 |
| | 7.LCD Contrast | — | Light Dark | Adjust the contrast of LCD. | 2-10 |
| 2.Fax | 1.Setup Receive (In Fax mode only) | 1.Ring Delay | Ring Delay 04 03 02 01 00 | Sets the number of rings before the machine answers in Fax Only, Fax/Tel or MC:Msg Ctr mode. | 4-3 |
| | | | Toll Saver On Off | Cost saving feature: the machine rings 2 times if there are messages and 4 times if there are no messages, so you can hang up and not pay for the call. | 4-4 |
| | | 2.F/T Ring Time | 70 Sec 40 Sec 30 Sec 20 Sec | Sets the pseudo/double-ring time in Fax/Tel mode. | 4-5 |
| | | 3.Easy Receive | On Semi Off | Receives fax messages without pressing the Black Start or Color Start key. | 4-5 |
| | | 4.Remote Code | On (* 51, #51) Off | You can answer all calls at an extension or external phone and use codes to turn the machine on or off. You can personalize these codes. | A-9 |
| | | 5.Auto Reduction | On Off | Reduces the size of incoming faxes. | 4-7 |
| | | 6.Polling RX | — | Sets up your machine to poll another fax machine. | 4-8 |



The factory settings are shown in Bold.

| Main Menu | Submenu | Menu Selections | Options | Descriptions | Page |
|----------------------|------------------------------------|------------------|--|--|------|
| 2.Fax (Continued) | 2.Setup Send (In Fax mode only) | 1.Contrast | Auto Light Dark | Changes the lightness or darkness of faxes you send. | 3-8 |
| | | 2.Fax Resolution | Standard Fine S.Fine Photo | Sets the default resolution for outgoing faxes. | 3-9 |
| | | 3.Delayed Fax | — | Set the time of day in 24 hour format that the delayed faxes will be sent. | 3-15 |
| | | 4.Batch TX | On Off | Combines delayed faxes to the same fax number at the same time of day into one transmission. | 3-16 |
| | | 5.Real Time TX | Off On Next Fax Only | You can send a fax without using the memory. | 3-11 |
| | | 6.Polled TX | On Off | Sets up your machine with an document to be retrieved by another fax machine. | 3-15 |
| | | 7.Overseas Mode | On Off | If you are having difficulty sending faxes overseas, set this to On. | 3-14 |
| | | 0.Scan Size | Letter A4 | Adjust the scan area of the scanner glass to the size of the document. | 3-16 |



The factory settings are shown in Bold.

| Main Menu | Submenu | Menu Selections | Options | Descriptions | Page |
|----------------------|---------------------|--|---|---|------------|
| 2.Fax (Continued) | 3.Set Quick-Dial | 1.One-Touch Dial (FAX-2440C only) | | Stores One-Touch Dial numbers, so you can dial by pressing one key (and Start). | 5-1 |
| | | 1.Speed-Dial (MFC-620CN) 2.Speed-Dial (FAX-2440C) | — | Stores Speed-Dial numbers, so you can dial by pressing only a few keys (and Start). | 5-2 |
| | | 2.Setup Groups (MFC-620CN) 3.Setup Groups (FAX-2440C) | — | Sets up a Group number for Broadcasting. | 5-5 |
| | 4.Report Setting | 1.Transmission | On On+Image Off Off+Image | Initial setup for Transmission Verification Report and Fax Journal Report. | 8-1 |
| | | 2.Journal Period | Every 7 Days Every 2 Days Every 24 Hours Every 12 Hours Every 6 Hours Every 50 Faxes Off | | 8-2 |
| | 5.Remote Fax Opt | 1.Fwd/Page/ Store | Off Fax Forward Paging Fax Storage PC Fax Receive (MFC-620CN only) | Sets the machine to forward fax messages, to call your pager, to store incoming faxes in the memory (so you can retrieve them while you are away from your machine), or to send faxes to your PC. | 6-1 6-2 |
| | | | 2.Remote Access | | ---* |
| | | 3.Print Fax (Backup Print) | — | Prints incoming faxes stored in the memory. | 4-8 6-3 |
| | 6.Remaining Jobs | — | — | Checks which jobs are in the memory and lets you cancel selected jobs. | 3-12 |



The factory settings are shown in Bold.

| Main Menu | Submenu | Menu Selections | Options | Descriptions | Page |
|----------------------|--------------------|-----------------------|--|---|-------|
| 2.Fax (Continued) | 7.Setup Msg Ctr | 1. OGM | Msg Ctr OGM F/T OGM | Play/Record or erase the outgoing message. | 7-2 |
| | | 2. ICM Max. Time | 180 120 60 30 | Select the maximum length of incoming messages. | 7-7 |
| | | 3. ICM Rec. Monitr | On Off | Allows you to turn the speaker volume for voice messages as they come in On or Off. | 7-7 |
| | 0.Miscellaneous | 1.Compatibility | Normal Basic | Adjust the transmission that are having problem. | 12-13 |
| | | 2.Distinctive | Off Set (On) | Uses the Telephone Company's Distinctive Ring subscriber service to register the ring pattern with the machine. | A-1 |
| | | 3.Caller ID | Display# Print Report | View or print a list of the last 30 Caller IDs stored in the memory. | A-5 |
| 3.Copy | 1.Quality | | Best Normal Fast | Selects the Copy resolution for your type of document. | 9-13 |
| | 2.Brightness | — | - □□□□ + - □□□□ + - □□□□ + - □□□□ + - ■□□□ + | Adjusts the brightness. | 9-13 |
| | 3.Contrast | — | - □□□□ + - □□□□ + - □□□□ + - □□□□ + - ■□□□ + | Adjusts the contrast for copies. | 9-13 |



The factory settings are shown in Bold.

| Main Menu | Submenu | Menu Selections | Options | Descriptions | Page |
|------------------------------------|-------------------|-----------------|--|--|-------|
| 3.Copy (Continued) | 4.Color Adjust | 1.Red | R:- 0000■ + R:- 0000■ + R:- 0000■ + R:- 0■000 + R:- ■0000 + | Adjusts the amount of Red in copies. | 9-14 |
| | | 2.Green | G:- 0000■ + G:- 0000■ + G:- 0000■ + G:- 0■000 + G:- ■0000 + | Adjusts the amount of Green in copies. | |
| | | 3.Blue | B:- 0000■ + B:- 0000■ + B:- 0000■ + B:- 0■000 + B:- ■0000 + | Adjusts the amount of Blue in copies. | |
| 4.PhotoCapture (MFC-620CN only) | 1.Print Quality | — | Normal Photo | Selects the print quality. | 10-9 |
| | 2.Paper & Size | — | Letter Glossy 4"x 6" Glossy 5"x 7" Glossy A4 Glossy Letter Plain A4 Plain Letter Inkjet A4 Inkjet 4"x 6" Inkjet | Selects the paper and print size. | 10-9 |
| | 3.Brightness | — | - 0000■ + - 0000■ + - 0000■ + - 0000■ + - ■0000 + | Adjusts the brightness. | 10-9 |
| | 4.Contrast | — | - 0000■ + - 0000■ + - 0000■ + - 0000■ + - ■0000 + | Adjusts the contrast. | 10-10 |



The factory settings are shown in Bold.

| Main Menu | Submenu | Menu Selections | Options | Descriptions | Page |
|--|------------------|-------------------------------|---|--|--------|
| 4.PhotoCapture (MFC-620CN only) (Continued) | 5.True2Life | True2Life:On True2Life:Off | 1.White Balance - ooooo + - oooou + - ooouo + - ouooo + - uoooo + | Adjusts the hue of the white areas. | 10-10 |
| | | | 2.Sharpness - ooooo + - oooou + - ooouo + - ouooo + - uoooo + | Enhances the detail of the image. | |
| | | | 3.Color Density - ooooo + - oooou + - ooouo + - ouooo + - uoooo + | Adjusts the total amount of color in the image. | |
| | 6.Cropping | — | Cropping:On Cropping:Off | Crops the image around the margin to fit the paper size or print size. Turn this feature Off if you want to print whole images or prevent unwanted cropping. | 10-12 |
| 7.Borderless | — | On Off | Expands the printable area to fit the edges of the paper | 10-12 | |
| 8.Scan to Card | 1.Quality | | B/W 200x100 dpi B/W 200 dpi Color 150 dpi Color 300 dpi Color 600 dpi | Selects the Scan resolution for your type of document. | 2-25*1 |
| | 2.B/W File Type | | TIFF PDF | Selects the default file format for black and white scanning. | 2-25*1 |
| | 3.ColorFile Type | | PDF JPEG | Selects the default file format for color scanning. | 2-25*1 |



The factory settings are shown in Bold.

*1 See the complete Software User's Guide on the CD-ROM.

| Main Menu | Submenu | Menu Selections | Options | Descriptions | Page |
|------------------------------|--------------------|------------------|---|---|---|
| 5.LAN (MFC-620CN only) | 1.Setup TCP/IP | 1.BOOT Method | Auto Static RARP BOOTP DHCP | You can choose the BOOT method that best suits you needs. | See Network User's Guide on the CD-ROM |
| | | 2.IP Address | [000-255]. [000-255]. [000-255]. [000-255] | Enter the IP address. | |
| | | 3.Subnet Mask | [000-255]. [000-255]. [000-255]. [000-255] | Enter the Subnet mask. | |
| | | 4.Gateway | [000-255]. [000-255]. [000-255]. [000-255] | Enter the Gateway address. | |
| | | 5.Host Name | BRN_XXXXXX | Enter the Host name. | |
| | | 6.WINS Config | Auto Static | You can choose the WINS configuration mode. | |
| | | 7.WINS Server | (Primary) 000.000.000.000 | Specifies the IP address of the primary or secondary server. | |
| | | 8.DNS Server | (Primary) 000.000.000.000 | Specifies the IP address of the primary or secondary server. | |
| | | 9.APIPA | On Off | Automatically allocates the IP address from the link-local address range. | |
| | 2.Setup Misc. | 1.Ethernet | Auto 100B-FD 100B-HD 10B-FD 10B-HD | Selects Ethernet link mode. | |
| | | 2.Time Zone | GMT-05:00 | Sets the time zone for your country. | |
| | 0.Factory Reset | — | — | Restore all network settings to factory default. | |



The factory settings are shown in Bold.

| Main Menu | Submenu | Menu Selections | Options | Descriptions | Page |
|--|-----------------------------------|-----------------|--------------------------------------|--|-----------------------|
| 4.Print Reports (FAX-2440C only) 6.Print Reports (MFC-620CN only) | 1.Help List | — | — | You can print these lists and reports. | 8-3 |
| | 2.Quick-Dial | — | — | | |
| | 3.Fax Journal | — | — | | |
| | 4.Transmission | — | — | | |
| | 5.User Settings | — | — | | |
| | 6.Network Config (MFC-620CN only) | — | — | | |
| 0.Initial Setup | 1.Receive Mode | — | Fax Only Fax/Tel Manual | You can choose the receive mode that best suits your needs. | 4-1 |
| | 2.Date/Time | — | — | Puts the date and time on the LCD and in headings of faxes you send. | 2-1 |
| | 3.Station ID | — | Fax: Name: | Program your name and fax number to appear on each page you fax. | 2-2 |
| | 4.Tone/Pulse | — | Tone Pulse | Selects the dialing mode. | 2-1 |
| | 0.Local Language (Canada only) | — | English French | Allows you to change the LCD Language for your country. | See Quick Setup Guide |



The factory settings are shown in Bold.

Entering Text

When you are setting certain menu selections, such as the Station ID, you may need to type text into the machine. Most number keys have three or four letters printed above them. The keys for **0**, **#** and ***** do not have printed letters because they are used for special characters.

By pressing the appropriate number key repeatedly, you can access the character you want.

| Press Key | one time | two times | three times | four times |
|-----------|----------|-----------|-------------|------------|
| 2 | A | B | C | 2 |
| 3 | D | E | F | 3 |
| 4 | G | H | I | 4 |
| 5 | J | K | L | 5 |
| 6 | M | N | O | 6 |
| 7 | P | Q | R | S |
| 8 | T | U | V | 8 |
| 9 | W | X | Y | Z |

Inserting spaces

To enter a space in the fax number, press ► once between numbers. To enter a space in the name, press ► twice between characters.

Making corrections

If you entered a letter incorrectly and want to change it, press ◀ to move the cursor under the incorrect character. Then press **Stop/Exit**. All letters above and to the right of the cursor will be deleted. Re-enter the correct character. You can also back up and type over incorrect letters.

Repeating letters

If you need to enter a character that is on the same key as the previous character, press ► to move the cursor to the right before you press the key again.

Special characters and symbols

Press *****, **#** or **0**, and then press **◀** or **▶** to move the cursor under the special character or symbol you want. Then press **Menu/Set** to select it.

Press ***** for (space) ! " # \$ % & ' () * + , - . / €

Press **#** for : ; < = > ? @ [] ^ _

Press **0** for É À È Ê Î Ç Ë Ö 0

G Glossary

ADF (automatic document feeder) The document can be placed in the ADF and scanned one page at a time automatically.

Auto Reduction Reduces the size of incoming faxes.

Automatic fax transmission Sending a fax without picking up the handset or pressing **Speaker Phone**.

Automatic Redial A feature that enables your machine to redial the last fax number after five minutes if the fax did not go through because the line was busy.

Backup Print Your machine prints a copy of every fax that is received and stored in memory. This is a safety feature so you will not lose messages during a power failure.

Batch Transmission (Black and white faxes only) As a cost saving feature, all delayed faxes to the same fax number will be sent as one transmission.

Beeper Volume Volume setting for the beep when you press a key or make an error.

Brightness Changing the Brightness makes the whole image lighter or darker.

Broadcasting The ability to send the same fax message to more than one location.

Caller ID A service purchased from the telephone company that lets you see the number (or name) of the party calling you.

Cancel Job Cancels a programmed job, like Delayed Fax or Polling.

CNG tones The special tones (beeps) sent by fax machines during automatic transmission to tell the receiving machine that a fax machine is calling.

Coding method Method of coding the information contained in the document. All fax machines must use a minimum standard of Modified Huffman (MH). Your machine is capable of greater compression methods, Modified Read (MR), Modified Modified Read (MMR) and JPEG, if the receiving machine has the same capability.

Communication error (or Comm. Error) An error during fax sending or receiving, usually caused by line noise or static.

Compatibility group The ability of one fax unit to communicate with another. Compatibility is assured between ITU-T Groups.

Contrast Setting to compensate for dark or light documents, by making faxes or copies of dark documents lighter and light documents darker.

Delayed Fax Sends your fax at a specified later time that day.

Distinctive Ring A subscriber service purchased from the telephone company that gives you another phone number on an existing phone line. The Brother machine uses the new number to simulate a dedicated fax line.

Dual Access Your machine can scan outgoing faxes or scheduled jobs into memory at the same time it is sending a fax or receiving or printing an incoming fax.

Easy Receive Enables your machine to respond to CNG tones if you interrupt a fax call by answering it.

ECM (Error Correction Mode) Detects errors during fax transmission and resends the pages of the fax that had an error.

Extension phone A telephone on the fax number that is plugged into a separate wall jack.

External phone A telephone that is plugged into the EXT jack of your machine.

F/T Ring Time The length of time that the Brother machine rings (when the Receive Mode setting is Fax/Tel) to notify you to pick up a voice call that it answered.

Fax Forwarding Sends a fax received into the memory to another pre-programmed fax number.

Fax Receive Code Press this code (✖ **5 1**) when you answer a fax call on an extension or external phone.

Fax Storage You can store faxes in memory.

Fax tones The signals sent by sending and receiving fax machines while communicating information.

Fax/Tel You can receive faxes and telephone calls. Do not use this mode if you are using a telephone answering device (TAD).

Fine resolution Resolution is 203 x 196 dpi. It is used for small print and graphs.

Gray scale The shades of gray available for copying and faxing photographs.

Group number A combination of One-Touch (FAX-2440C only) and Speed-Dial numbers that are stored on a One-Touch key or in a Speed-Dial location for Broadcasting.

Help list A printout of the complete Menu table that you can use to program your machine when you do not have the User's Guide with you.

Fax Journal Lists information about the last 200 incoming and outgoing faxes. TX means Transmit. RX means Receive.

Journal Period The pre-programmed time period between automatically printed Fax Journal Reports. You can print the Fax Journal on demand without interrupting the cycle.

LCD (liquid crystal display) The display screen on the machine that shows interactive messages during On-Screen Programming and shows the date and time when the machine is idle.

Manual fax When you lift the handset of the machine (FAX-2440C only) or press **Speaker Phone** so you can hear the receiving fax machine answer before you press **Black Start** or **Color Start** to begin transmission.

Menu mode Programming mode for changing your machine's settings.

OCR (optical character recognition) (MFC-620CN only) The bundled ScanSoft® OmniPage® software application converts an image of text to text you can edit.

- One-Touch (FAX-2440C only)** Keys on the machine's control panel where you can store numbers for easy dialing. You can store a second number on each key if you press **Shift** and the One-Touch Key together.
- Out of Paper Reception** Receives faxes into the machine's memory when the machine is out of paper.
- Overseas Mode** Makes temporary changes to the fax tones to accommodate noise and static on overseas phone lines.
- Paging** This feature enables your machine to call your pager when a fax is received into its memory. The machine will also page for voice messages.
- Pause** Allows you to place a 3.5 second delay in the dialing sequence stored on One-Touch keys (FAX-2440C) and Speed-Dial numbers. Press **Redial/Pause** as many times as needed for longer pauses.
- PhotoCapture Center™ (MFC-620CN only)** Allows you to print digital photos from your digital camera at high resolution for photo quality printing.
- Photo resolution** A resolution setting that uses varying shades of gray for the best representation of photographs.
- Polling** The process of a fax machine calling another fax machine to retrieve waiting fax messages.
- Pulse** A form of rotary dialing on a telephone line.
- Quick Dial List** A listing of names and numbers stored in One-Touch (FAX-2440C only) and Speed-Dial memory, in numerical order.
- Real Time Transmission** When memory is full, you can send faxes in real time.
- Remaining jobs** You can check which jobs are waiting in memory and cancel jobs individually.
- Remote Access Code** Your own four-digit code (--- ✳) that allows you to call and access your machine from a remote location.
- Remote Retrieval Access** The ability to access your machine remotely from a touch tone phone.

Resolution The number of vertical and horizontal lines per inch.
See: Standard, Fine, Super Fine and Photo.

Ring Delay The number of rings before the machine answers in
Fax Only, Fax/Tel and MC:Msg Ctr mode.

Ring Volume Volume setting for the machine's ring.

Scanning (MFC-620CN only) The process of sending an
electronic image of a paper document into your computer.

Scan to Card (MFC-620CN only) You can scan a black and white
or color document into a Media Card. Black and white images will
be in TIFF or PDF file format and color images may be in PDF or
JPEG file format.

Search An electronic, alphabetical listing of stored One-Touch
(FAX-2440C), Speed-Dial and Group numbers.

Speed-Dial A pre-programmed number for easy dialing. You must
press the **Search/Speed Dial**, #, and the two digit code, and
Black Start or **Color Start** to start the dialing process.

Standard resolution 203 x 97 dpi. It is used for regular size text
and quickest transmission.

Station ID The stored information that appears on the top of faxed
pages. It includes the sender's name and fax number.

Super Fine resolution 392 x 203 dpi. Best for very small print and
line art.

TAD (telephone answering device) You can connect an external
device or answering machine to the EXT. jack of your machine.

Telephone Answer Code (Fax/Tel mode only) When the
machine answers a voice call, it pseudo/double-rings. You can
pick up at an extension phone by pressing this code (**# 5 1**).

Temporary settings You can select certain options for each fax
transmission and copy without changing the default settings.

Tone A form of dialing on the telephone line used for Touch Tone
telephones.

Transmission The process of sending faxes over the phone lines
from your machine to the receiving fax machine.

Transmission Verification Report A listing for each transmission, that shows its date, time and number.

True2Life® (MFC-620CN only) Adjusts the color in the image for better print quality by improving sharpness, white balance and color density.

User Settings A printed report that shows the current settings of the machine.

S Specifications

Product description

General

| | |
|--|--|
| Memory Capacity | 8 MB (FAX-2440C) 16 MB (MFC-620CN) |
| Automatic Document Feeder (ADF) | Up to 10 pages |
| Paper Tray | 100 Sheets (20 lb) |
| Printer Type | Ink Jet |
| Print Method | Piezo with 74 × 5 nozzles |
| LCD (Liquid Crystal Display) | 16 characters × 1 line (FAX-2440C) 16 characters × 2 lines (MFC-620CN), Back light |
| Power Source | 100 - 120V AC 50/60Hz |
| Power Consumption | (FAX-2440C) Off Mode: 3 Wh or less Standby: 8 Wh or less Operating: 25 Wh or less (MFC-620CN) Off Mode: 3.5 Wh or less Standby: 9.5 Wh or less Operating: 27 Wh or less |

Dimensions

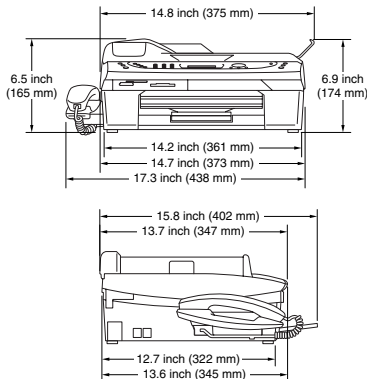

| | |
|--------------------|---|
| Weight | 13 lb |
| Noise | Operating: 42.5 to 51 dB* * It depends on printing conditions |
| Temperature | Operating: 50°F - 95°F Best Print Quality: 68°F - 91°F |
| Humidity | Operating: 20 to 80% (without condensation) Best Print Quality: 20 to 80% (without condensation) |

Print media

Paper Input

Paper Tray

- Paper type:
Plain paper, inkjet paper (coated paper), glossy paper*², transparencies*^{1*2} and envelopes
- Paper size:
Letter, Legal*³, Executive, A4, A5, A6, JIS_B5, envelopes (commercial No.10, DL, C5, Monarch, JE4), Photo card, Index card and Post card.
For more details, see *Paper weight, thickness and capacity* on page 1-13.
- Maximum paper tray capacity: Approx. 100 sheets of 20 lb plain paper

Paper Output

Up to 25 sheets of Letter plain paper (Face up print delivery to the output paper tray)*²

*¹ Use only transparencies recommended for inkjet printing.

*² For glossy paper or transparencies, we recommend removing printed pages from the output paper tray immediately after they exit the machine to avoid smudging.

*³ Legal paper cannot be stacked on the output paper tray.

Copy

Color/Black

Color/Black

Document Size

ADF Width: 5.8" to 8.5"

ADF Height: 5.8" to 14"

Scanner Glass Width: 8.5 in.

Scanner Glass Height: 11.7 in.

Copy Speed

Mono

Up to 17 pages/minute (Letter paper)*

Color

Up to 11 pages/minute (Letter paper)*

* Does not include the time it takes to feed the paper.

Based on Brother standard pattern. (Fast mode/Stack Copy)

Copy speeds vary with the complexity of the document.

Multiple Copies

Stacks/Sorts up to 99 pages

Enlarge/Reduce

25% to 400% (in increments of 1%)

Resolution

Up to 600 x 1200 dpi copy resolution for plain, inkjet or glossy paper and up to 1200 x 1200 dpi for OHP/transparency

PhotoCapture Center™ (MFC-620CN only)

Available Media

CompactFlash® Version 1.0
(Type I only)
(Microdrive™ is not compatible)
(Compact I/O card such as Compact LAN card
and Compact Modem card are not supported.)
SmartMedia® (3.3V)
(Not available for use with ID)
Memory Stick®
(Not available for music data with MagicGate™)
Secure Digital™
xD-Picture Card™

File Extension

(Media Format)
(Image Format)

DPOF, EXIF, DCF
Photo Print: JPEG*
Scan to Card: JPEG, PDF (Color)
TIFF, PDF (Black)

* Progressive JPEG format is not supported.

Color Enhancement

True2Life

Number of Files

Up to 999 files in the media card

Folder

File must be in the 3rd folder level of the Media Card.

Borderless

Letter, A4, Photo Card

Fax

| | |
|--|---|
| Compatibility | ITU-T Group 3 |
| Coding System | MH/MR/MMR/JPEG |
| Modem Speed | Automatic Fallback 14400 bps |
| Document Size | ADF Width: 5.8" to 8.5" ADF Height: 5.8" to 14" Scanner Glass Width: 8.5 in. Scanner Glass Height: 11.7 in. |
| Scanning Width | 8.2 in. |
| Printing Width | 8.03 in. |
| Gray Scale | 256 levels |
| Polling Types | Standard, Sequential: (Black only) |
| Contrast Control | Automatic/Light/Dark (manual setting) |
| Resolution | <ul style="list-style-type: none">• Horizontal 203 dot/inch (8 dot/mm)• Vertical Standard -<ul style="list-style-type: none">98 line/inch (Black)196 line/inch (Color)Fine - 196 line/inch (Black/Color)Photo - 196 line/inch (Black)Superfine - 392 line/inch (Black) |
| One-Touch Dial (FAX-2440C only) | 6 (3 x 2) |
| Speed-Dial | 80 stations |
| Broadcasting | 130 stations (MFC-620CN) 136 stations (FAX-2440C) |
| Automatic Redial | 1 time after 5 minutes |
| Auto Answer | 0, 1, 2, 3 or 4 rings |
| Communication Source | Public switched telephone network. |

| | |
|-------------------------------|---|
| Memory Transmission | Up to 480* ¹ /400* ² pages (MFC-620CN only) Up to 300* ¹ /250* ² pages (FAX-2440C) |
| Out of Paper Reception | Up to 480* ¹ /400* ² pages (MFC-620CN only) Up to 300* ¹ /250* ² pages (FAX-2440C) |

*1 "Pages" refers to the "Brother Standard Chart No. 1" (a typical business letter, Standard resolution, MMR code). Specifications and printed materials are subject to change without prior notice.

*2 "Pages" refers to the "ITU-T Test Chart #1" (a typical business letter, Standard resolution, MMR code). Specifications and printed materials are subject to change without prior notice.

Scanner (MFC-620CN only)

| | |
|-------------------------|---|
| Color/Monochrome | Color/Monochrome |
| TWAIN Compliant | Yes (Windows [®] 98/98SE/Me/2000 Professional/XP) Mac OS [®] 8.6-9.2/Mac OS [®] X 10.2.4 or greater |
| WIA Compliant | Yes (Windows [®] XP) |
| Color Depth | 36 bit color Processing (Input) 24 bit color Processing (Output) |
| Resolution | Up to 19200 × 19200 dpi (interpolated)* Up to 600 × 2400 dpi (optical) * Maximum 1200 x 1200 dpi scanning with Windows [®] XP (resolution up to 19200 x 19200 dpi can be selected by using the Brother scanner utility) |
| Scanning Speed | Color: up to 5.58 sec. Mono: up to 3.54 sec. Letter size in 100 × 100 dpi |
| Document Size | ADF Width: 5.8" to 8.5" ADF Height: 5.8" to 14" Scanner Glass Width: Max. 8.5" Scanner Glass Height: Max. 11.7" |
| Scanning Width | 8.26 in. |
| Gray Scale | 256 levels |



Mac OS[®] X scanning is supported in Mac OS[®] X 10.2.4 or greater.

Printer



For FAX-2440C, you can download the Brother Printer Driver from the Brother Solutions Center. Visit us at:

<http://solutions.brother.com>

| | |
|-------------------------|--|
| Printer Driver | Windows® 98/98SE/Me/2000 Professional and XP driver supporting Brother Native Compression mode and bi-directional capability Apple® Macintosh® QuickDraw® Driver For Mac OS® 8.6-9.2/Mac OS® X 10.2.4 or greater |
| Resolution | Up to 1200 x 6000 dots per inch (dpi)* 1200 x 1200 dots per inch (dpi) 600 x 600 dots per inch (dpi) 600 x 150 dots per inch (dpi) <small>* Output image quality varies based upon many factors including but not limited to input image resolution and quality and print media.</small> |
| Print Speed | up to 20 pages/minute (Mono)* up to 15 pages/minute (Color)* <small>* Based on Brother standard pattern. Letter size in draft mode. Does not include the time it takes to feed the paper.</small> |
| Printing Width | 8.03 inches (8.25 inches)* <small>* When you set the Borderless feature to On.</small> |
| Disk-Based Fonts | 35 TrueType |
| Borderless | Letter, A4, A6, Photo Card, Index Card, Post Card |

Interfaces

USB

A Full-Speed USB 2.0 cable that is no longer than 6 feet (2.0m).*

LAN cable (MFC-620CN only)

Ethernet UTP cable category 5 or greater.

* Your machine has a Full-Speed USB 2.0 interface. This interface is compatible with Hi-Speed USB 2.0; however, the maximum data transfer rate will be 12 Mbits/s. The machine can also be connected to a computer that has a USB 1.1 interface.

Computer requirements

| Minimum System Requirements | | | | | | |
|---|---|---|-------------|-----------------|---------------------------|------------------|
| Computer Platform & Operating System Version | | Processor Minimum Speed | Minimum RAM | Recommended RAM | Available Hard Disk Space | |
| | | | | | for Drivers | for Applications |
| Windows® *1 Operating System | 98, 98SE | Pentium II or equivalent | 32 MB | 64 MB | 90 MB | 130 MB |
| | Me | | 64 MB | 128 MB | | |
| | 2000 Professional | | 128 MB | 256 MB | 150 MB | 220 MB |
| | XP*2 | | | | | |
| Apple® Macintosh® Operating System | Mac OS® 8.6 (Printing and PC-FAX Send*3 Only) | All base models meet minimum Requirements | | 64 MB | 80 MB | 200 MB |
| | Mac OS® 9.X (Printing, Scanning*4, PhotoCapture Center™ and PC-FAX Send*3 Only)*5 | | | | | |
| | Mac OS® X 10.2.4 or greater | | 128 MB | 160 MB | | |
| NOTE: All registered trademarks referenced herein are the property of their respective companies. | | | | | | |
| For the latest drivers, go to the Brother Solutions Center at http://solutions.brother.com/ | | | | | | |

*1 Microsoft® Internet Explorer 5 or greater.

*2 Maximum 1200 x 1200 dpi scanning with Windows® XP. (Resolutions up to 19200 x 19200 dpi can be selected using the Brother Utility.)

*3 PC Fax Supports black and white faxing only.

*4 Dedicated "Scan" key and direct Network Scanning (MFC-620CN only) supported in Mac® Operating Systems Mac OS® X 10.2.4 or greater.

*5 Scanning and PhotoCapture Center™ are supported only for MFC-620CN.

Consumable items

Ink

The machine uses individual Black, Yellow, Cyan and Magenta ink cartridges that are separate from the print head assembly.

Service Life of Ink Cartridge

Standard Black - Approximately 500 pages at 5% coverage

High Yield Black - Approximately 900 pages at 5% coverage (FAX-2440C only)

Yellow, Cyan and Magenta - Approximately 400 pages at 5% coverage

The above figures are based upon the following assumptions:

- Continuous printing at a resolution of 600 x 600 dpi in normal mode after installing new ink cartridge;
- The printing frequency;
- The number of pages printed;
- Periodic, automatic, print head assembly cleaning (Your machine will clean the print head assembly periodically. This process will use a small amount of ink) ; and,
- Ink remaining in cartridge identified as “empty” (It is necessary to leave a small amount of ink in the ink cartridge to prevent air from drying out and damaging the print head assembly).

Network (LAN) (MFC-620CN only)

LAN You can connect your machine to a network for Network Printing, Network Scanning and PC Fax Send. Also included is Brother BRAdmin Professional Network Management software.

Support for Windows® 98/98SE/Me/2000/XP
Mac OS® 8.6 - 9.2, Mac OS® X 10.2.4 or greater*
Ethernet 10/100 BASE-TX Auto Negotiation

Protocols TCP/IP
RARP, BOOTP, DHCP, APIPA, NetBIOS, WINS
LPR/LPD, Port9100, SSDP, mDNS, FTP

* Network Printing and PC-FAX are available for Mac OS® 8.6-9.2, Mac OS® 10.2.4 or greater.

* Mac OS® 8.6-9.2 (Quick Draw over TCP/IP)

* Mac OS® X 10.2.4 or greater (mDNS)

* Network Scanning and Remote Setup are available for Mac OS® 10.2.4 or greater.

* Media drive is not available for Mac OS® 8.6

Included Utilities:

BRAdmin Professional (Windows®)



BRAdmin Professional is not supported in Mac OS®.

Optional External Wireless Print/Scan Server (NC-2200w) (MFC-620CN only)

NC-2200w External Wireless Print/Scan Server (Optional)

Connecting the optional External Wireless Print/Scan Server (NC-2200w) to your machine will allow you to print and scan over a wireless network.

Network types

IEEE 802.11b wireless LAN

Support for

Windows® 98/98SE/Me/2000/XP
Mac OS® X 10.2.4 or greater

Protocols

TCP/IP
ARP, RARP, BOOTP, DHCP, APIPA (Auto IP),
WINS/NetBIOS, DNS, LPR/LPD, Port9100,
SMB Print, IPP, RawPort, mDNS, TELNET, SNMP,
HTTP



You can assign the scan key to one networked computer only.

Index

A

- Access codes, storing and dialing 5-7, 5-8
- Accessories and supplies ii
- ADF (automatic document feeder) 1-7, 3-4
- ADF cover 12-5
- Answering machine (TAD) ... A-11
 - connecting A-13
- Automatic
 - fax receive 4-1
 - Easy Receive 4-6
 - fax redial 3-3
 - transmission 3-6

B

- Broadcasting 3-13
 - setting up Groups for ... 5-4, 5-5
- Brother
 - accessories and supplies ii
 - Brother numbers i
 - Customer Service i
 - fax back system ii
 - Frequently asked questions (FAQs) i
 - product support i
 - Warranties iii, iv, vi

C

- Caller ID A-5
 - print list A-6
 - view list A-6
- Canceling
 - Fax Forwarding 6-7
 - fax jobs in memory 3-12
 - jobs awaiting redial 3-12
 - Paging 6-7

- Cleaning
 - print head 12-14
 - printer platen 12-23
 - scanner 12-22
- CNG tones 1-20
- Connecting
 - external TAD A-11
 - external telephone A-10
 - two-line external TAD or telephone A-16
- Consumable items S-10
- Control Center
 - See Software User's Guide on the CD-ROM.
- Control panel overview 1-2
- Copy
 - brightness 9-8
 - color adjustment 9-14
 - contrast 9-13
 - default settings 9-13
 - Enlarge/Reduce 9-4, 9-6
 - enter Copy mode 9-1
 - keys 9-3
 - multiple 9-2
 - Out of Memory 9-14
 - Page Layout 9-10
 - paper 9-7
 - Quality key 9-5
 - quality setting 9-13
 - single 9-2
 - Sort (ADF only) 9-9
 - temporary settings 9-3
 - using ADF 9-2
- Copy Options key (copying)
 - Brightness 9-8
 - Paper Size 9-8
 - Paper Type 9-7
- Cordless phone A-9

Credit card numbers5-7, 5-8
Custom telephone features
on a single line 12-12, A-17

D

Date and Time2-1
Delayed Batch
Transmission3-16
Dialing
a pause5-8
access codes and credit
card numbers5-7, 5-8
automatic fax redial3-3
automatic transmission3-6
Groups3-13
manual3-1
Speed-Dial3-2
Distinctive RingA-1
setting ring patternA-4
turning offA-4
Dual Access3-10

E

Easy Receive4-6
ECM (Error Correction
Mode)1-21
Envelopes1-14
Equalization12-13
Error messages on LCD ...12-1
Comm. Error12-1
Ink Empty12-2
Near Empty12-2
No Paper Fed12-3
Not Registered3-2, 12-3
Out of Memory12-3
while scanning
a document9-14
Unable to Change12-4
Extension telephone,
usingA-7

External telephone,
connectingA-10

F

Fax codes
changing6-5, A-9
Fax Receive Code4-6, A-7
Remote Access Code6-5
Telephone Answer Code ...A-7
Fax Forwarding
changing remotely6-7, 6-9
programming a number ...6-1
Fax Storage6-3
printing from memory4-8
turning on6-3
Fax, from PC
See Software User's Guide on
the CD-ROM.....
Fax, stand-alone
receiving4-1
at end of conversation ...4-7
compatibility12-13
difficulties12-10
Easy Receive4-6
Fax Forwarding6-7
from extension phone ...A-7
Paging6-2
Polling Receive4-8
reducing to fit on paper ...4-7
retrieving from a remote
site6-9
Ring Delay, setting4-3
Sequential Polling4-9
sending3-1
at end of conversation ...3-7
automatic3-6
Broadcasting3-13
canceling from
memory3-12
color fax3-4

compatibility 12-13
 contrast 3-8
 enter Fax mode 3-1
 from memory
 (Dual Access) 3-3, 3-10
 from scanner glass 3-5
 manual 3-6
 overseas 3-14
 Real Time
 Transmission 3-11
 resolution 3-9
 Fax/Tel mode 4-1
 Announcement 7-2
 answering at extension
 phones A-7
 double-ringing
 (voice calls) 4-5
 F/T Ring Time 4-5
 Fax Receive Code A-7
 Ring Delay 4-3
 Telephone Answer Code ... A-7
 FCC notices 11-1

G

Gray scale S-5, S-6
 Groups for
 Broadcasting 5-4, 5-5

H

Hearing aid compatible 2-8
 HELP
 LCD messages B-1
 using navigation keys ... B-2
 Menu Table B-1, B-3
 Hold 5-11

I

Ink cartridges
 checking ink volume 12-18
 replacing 12-24

Ink Dot Counter 12-24

J

Jacks
 convert to RJ11 jack
 triplex adapter A-14
 EXT
 external telephone A-11
 TAD (answering
 machine) A-11
 Jams
 document 12-5
 paper 12-5

L

LCD (liquid crystal
 display) B-1, B-2
 contrast 2-10
 Help List 8-3

M

Maintenance, routine 12-22
 Manual
 dialing 3-1, 5-10
 receive 4-1
 transmission 3-6
 Memory Storage B-1
 Menu Selection Table B-1
 Message Center mode 7-1
 erasing messages 7-6
 playing voice messages ... 7-5
 printing faxes from
 memory 7-5
 recording a conversation ... 7-8
 recording Fax/Tel
 announcement
 (F/T OGM) 7-8
 recording outgoing message
 (Msg Ctr OGM) 7-2
 setting up 7-1, 7-4

Mode, entering
 Copy9-1
 Fax3-1
 Scan 1-3
 Multi-line connections
 (PBX)A-17

N

Network
 Printing
 See Software User's Guide
 on the CD-ROM.....
 Scanning
 See Software User's Guide
 on the CD-ROM.....

O

One-Touch numbers
 storing5-1
 Out of Area (Caller ID)A-5
 Outgoing Message
 (Msg Ctr OGM) 7-2

P

Paging 6-2
 programming your pager
 number 6-1
 Paper 1-10, S-2
 document size3-4
 Size2-4
 size of document 1-7
 Type2-4

PaperPort®
 See Software User's Guide on
 the CD-ROM.....

Phone line
 connectionsA-13
 difficulties 12-11
 multi-line (PBX)A-17
 roll over linesA-14
 two-line phone system ...A-14

PhotoCapture Center™
 Borderless10-12
 CompactFlash®10-1
 Cropping10-12
 Default Settings 10-9
 DPOF printing 10-8
 from PC

See Software User's Guide
 on the CD-ROM.....

Memory Stick®10-1
 Printing images 10-6
 Printing Index 10-5
 Secure Digital™10-1
 SmartMedia®10-1
 specifications S-4
 xD-Picture Card™ 10-1

Polling4-8

Power failure B-1

Print
 area1-14
 difficulties 12-9, 12-10
 drivers S-7
 fax from memory4-8
 improving quality12-14
 paper jams 12-6
 report8-3
 resolution S-7
 specifications S-7

Programming your
 machineB-1, B-2

Q

Quality key (copying)9-3

Quick-Dial5-1

Access codes and
 credit card numbers
 setting up 5-7, 5-8

Broadcasting3-13
 using Groups3-13

| | |
|-----------------------|----------|
| Group dial | |
| changing | 5-3 |
| setting up Groups for | |
| Broadcasting | 5-4, 5-5 |
| One-Touch dial | |
| setting up | 5-1 |
| using | 3-2 |
| Search | 3-3 |
| Speed-Dial | |
| changing | 5-3 |
| setting up | 5-2 |
| using | 3-2 |

R

| | |
|------------------------------|----------|
| Receive Mode | |
| Fax/Tel | 4-1 |
| MC Msg. Ctr | 4-1 |
| Redial/Pause | 3-3 |
| Reducing | |
| copies | 9-4, 9-6 |
| incoming faxes | 4-7 |
| Remote Retrieval | 6-6 |
| access code | 6-5, 6-6 |
| commands | 6-7 |
| getting your faxes | 6-9 |
| See Software User's Guide on | |
| the CD-ROM. | |
| Reports | 8-1 |
| Caller ID List | A-6 |
| Fax Journal | 8-3 |
| Journal Period | 8-2 |
| Help List | 8-3 |
| how to print | 8-3 |
| Network Configuration | 8-3 |
| Quick-Dial List | 8-3 |
| Transmission | |
| Verification | 8-1, 8-3 |
| User Settings | 8-3 |

| | |
|----------------------------|-----|
| Resolution | |
| copy | S-3 |
| fax (Standard, Fine, | |
| SuperFine, Photo) | S-5 |
| print | S-7 |
| scan | S-6 |
| setting for next fax | 3-9 |
| Ring Delay, setting | 4-3 |

S

| | |
|------------------------------|-----------|
| Safety Instructions | vii, 11-6 |
| Scanning | |
| See Software User's Guide on | |
| the CD-ROM. | |
| Setup | |
| Date and Time | 2-1 |
| Station ID (fax header) | |
| entering text | 2-2 |
| Shipping the machine | 12-19 |
| Speed-Dial | |
| changing | 5-3 |
| dialing | 3-2 |
| storing | 5-2 |

T

| | |
|--------------------------------|-----------------|
| TAD (telephone answering | |
| device), external | |
| | 4-1, A-11, A-16 |
| connecting | A-11, A-13 |
| receive mode | 4-1 |
| recording OGM | A-13 |
| with two-line jack | A-16 |
| Temporary copy settings | 9-3 |
| Text, entering | B-12 |
| special characters | B-13 |
| Tone signals on Pulse line ... | 5-9 |
| Troubleshooting | 12-1 |
| checking ink volume | 12-18 |
| document jam | 12-5 |
| error messages on LCD ... | 12-1 |

| | |
|------------------------------|-------|
| if you are having difficulty | |
| copying | 12-12 |
| incoming calls | 12-12 |
| Network | 12-13 |
| phone line | 12-13 |
| phone line difficulties ... | 12-11 |
| PhotoCapture Center™ | 12-13 |
| printing | 12-9 |
| printing or receiving | |
| faxes | 12-10 |
| Printing Receiving | |
| Faxes | 12-10 |
| receiving faxes | 12-11 |
| scanning | 12-12 |
| sending faxes | 12-11 |
| software | 12-12 |
| paper jam | 12-6 |
| print quality | 12-14 |
| True2Life® | |
| PhotoCapture Center™ ... | 10-10 |
| Two-line phone system | A-14 |

U

| | |
|-----------------------|------|
| Unable to Clean | 12-4 |
| Unable to Init. | 12-4 |
| Unable to Print | 12-4 |
| Unable to Scan | 12-4 |

V

| | |
|-------------------------|-----|
| Volume, setting | 2-5 |
| beeper | 2-5 |
| handset | 2-8 |
| Volume Amplify (for | |
| hearing-impaired) | 2-9 |
| ring | 2-5 |
| speaker | 2-6 |

W

| | |
|-------------------------|-----|
| Warranties | iii |
| Canada | vi |
| Notice-Disclaimer | iii |
| USA | iv |
| World Wide Web | i |

Remote Retrieval Access card

If you plan to retrieve voice or fax messages while away from your machine, carrying the Remote Retrieval Access Card printed below will serve as a convenient reminder of the retrieval procedures. Simply cut out the card and fold it to fit in your wallet or organizer. Keeping it handy will help you derive the full benefit of your machine's Paging, Fax Forwarding, and Remote Retrieval features.

Changing Remote Access Code

- 1 Press **Menu/Set**, **2**, **5**, **2**.
- 2 Enter a three-digit number from 000 to 999. The * cannot be changed.
- 3 Press **Menu/Set**.
- 4 Press **Stop/EXIT**.

Remote Commands Listen to Voice Messages

- Press **9 1**
then to
- 1 Repeat a message, press **1**.
 - 2 Skip to next messages, press **2**.
- Stop playing the messages, press **9**.

Erase All Voice Messages

Press **9 3**. If you hear three beeps, all messages have not yet been played and the system will not erase them.

Play/Record Outgoing Message

- Press **9 4**
then to
- 1 Play Message Center OGM, press **1 1**.
 - 2 Play Fax/Tel OGM, press **1 2**.
- Record new Message Center OGM,
press **2 1**, then speak after the beep.
Press **9** to stop.
- Record new Fax/Tel OGM, press **2 2**,
and then speak after the beep.
Press **9** to stop.

Change Paging/Fax Forwarding Setting

- Press **9 5**
then to
- 1 Turn feature OFF, press **1**.
 - 2 Switch On Fax Forwarding Number, press **2**.
 - 3 Enter Paging Number, press **3**.
 - 4 Program Fax Forward Number, press **4**. Enter the new number of the remote fax machine where you want your fax messages forwarded followed by **#**.
 - 5 Select Fax Storage, press **6**.

Retrieve a Fax

- Press **9 6**
then to
- 1 Retrieve all faxes, press **2**, then enter the number of the remote fax machine followed by **#**.
 - 2 After the beep, hang up and wait.
 - 3 Erase all fax messages, press **3**.

Check Receiving Status

Press **9 7**

then for Fax messages, press **1**.

Voice messages, press **2**

1 long beep — Received message

3 short beeps — No messages

Change Receive Mode

Press **9 8**

then for MCM:Msg Ctr, press **1**.

Fax/Tel, press **2**

Fax Only, press **3**.

Exit Remote Retrieval

Press **9 0**

MESSAGE CENTER REMOTE RETRIEVAL ACCESS CARD

Using Remote Access Code

- 1 Dial your fax number from a telephone or fax machine using touch tone.
- 2 When your machine answers, immediately enter your Remote Access Code (3 digits followed by *).
- 3 Your fax machine signals the kinds of messages it received:
 - 1 long beep** — Fax messages
 - 2 long beeps** — Voice messages
 - 3 long beeps** — Voice and Fax messages
 - No beeps** — No messages
- 4 After 2 short beeps, enter a command.
- 5 Press **9 0** to reset the fax machine when you finish.
- 6 Hang up.

5

1

EQUIPMENT ATTACHMENT LIMITATIONS (Canada only)

NOTICE

This product meets the applicable Industry Canada technical specifications.

NOTICE

The Ringer Equivalence Number is an indication of the maximum number of devices allowed to be connected to a telephone interface. The termination on an interface may consist of any combination of devices subject only to the requirement that the sum of the RENs of all the devices does not exceed five.

brother®

Brother International Corporation
100 Somerset Corporate Boulevard
P.O. Box 6911
Bridgewater, NJ 08807-0911 USA

Brother International Corporation (Canada) Ltd.
1 rue Hôtel de Ville,
Dollard-des-Ormeaux, QC, CANADA H9B 3H6

Visit us on the World Wide Web
<http://www.brother.com>

These machines are made for use in the USA and Canada only. We cannot recommend using them overseas because it may violate the Telecommunications Regulations of that country and the power requirements of your multi-function center may not be compatible with the power available in foreign countries. **Using USA or Canada models overseas is at your own risk and may void your warranty.**



LF5803001