



## Multi-Protocol Print/Fax Server

# Network User's Guide

## NC-9100h

MFC-8440

MFC-8840D

MFC-8840DN

DCP-8040

DCP-8045D

Please read this manual thoroughly before using the machine. You can print or view this manual from the CD-ROM at any time, please keep the CD-ROM in a convenient place for quick and easy reference at all times.

The Brother Solutions Center (<http://solutions.brother.com>) is your one stop resource for all your machine needs. Download the latest drivers and utilities for your printers, read the FAQs and troubleshooting tips.

Some Brother machine models are network ready as standard. Other Brother printers can be upgraded with an optional Network Print Server.

## Trademarks

Brother is a registered trademark of Brother Industries, Ltd.

HP, HP/UX, JetDirect and JetAdmin are trademarks of Hewlett-Packard Company.

UNIX is a trademarks of UNIX Systems Laboratories.

Ethernet is trademark of Xerox Corporation.

Postscript is trademark of Adobe Systems Incorporated.

Netware is a trademark of Novell, Inc.

Apple, Macintosh, LaserWriter and AppleTalk are trademarks of Apple Computer, Inc.

IBM, LAN Server, and AIX are trademarks of International Business Machines Corporation.

LAN Manager, Windows®, and MS-DOS are trademarks of Microsoft Corporation.

NC-9100h and BRAdmin Professional utility are trademarks of Brother Industries Ltd.

All other brand and product names mentioned in this User's Guide are registered trademarks or trademarks of respective companies.

## Compilation and Publication

Under the supervision of Brother Industries Ltd., this manual has been compiled and published, covering the latest product descriptions and specifications.

The contents of this manual and the specifications of this product are subject to change without notice.

Brother reserves the right to make changes without notice in the specifications and materials contained herein and shall not be responsible for any damages (including consequential) caused by reliance on the materials presented, including but not limited to typographical and other errors relating to the publication.

©2004 Brother Industries Ltd.

### Shipment of the Print/Fax server

If for any reason you must ship your Print/Fax server, carefully package the Print/Fax server to avoid any damage during transit. It is recommended that you save and use the original packaging. The print server should also be adequately insured with the carrier.

#### WARNING

When shipping the Print/Fax server, put it into the anti-static bag to avoid damage.

**IMPORTANT NOTE:** For technical and operational assistance, you must call. Calls must be made **from within** that country.

**In USA** 1-800-276-7746

**In Canada** 1-877-BROTHER

**In Europe** Visit <http://www.brother.com> for contact information on your local Brother office.

If you have any comments or suggestions, please write to us at:

**In Europe** European Technical Services  
1 Tame Street  
Audenshaw  
Manchester, M34 5JE  
UK

**In USA** Printer Customer Support  
Brother International Corporation  
15 Musick  
Irvine CA 92618

**In Canada** Brother International Corporation (Canada), Ltd.  
- Marketing Dept.  
1, rue Hôtel de Ville  
Dollard-des-Ormeaux, PQ, Canada H9B 3H6

**Dealers and service centers (USA)**

For the name of a Brother authorized dealer or service center, call 1-800-284-4357.

**Service centers (Canada)**

For the address of service centers in Canada, call 1-877-BROTHER.

**Service centers locations (Europe)**

For service center in Europe, contact your local Brother office. Address and telephone contact information or European offices can be found at <http://www.brother.com> and selecting your country from the pull down list.

**Brother fax-back system (USA)**

Brother Customer Service has set up an easy-to-use fax-back system so you can get instant answers to common technical questions and information about all our products. This is available 24 hours a day, seven days a week. You can use the system to send the information to any fax machine.

Call the number below and follow the recorded instructions to receive a fax about how to use the system and an Index of the subjects you can get information about.

**In USA only** 1-800-521-2846

**Internet addresses**

Brother Global Web Site: <http://www.brother.com>

For Frequently Asked Questions (FAQs), Product Support and Technical Questions, and Driver Updates and Utilities: <http://solutions.brother.com>

(In USA Only) For Brother Accessories & Supplies: <http://www.brothermall.com>

# Introduction

---

## Overview

The Brother NC-9100h Print / Fax Server allows your Brother machine to be attached and shared on a 10/100Mbit Ethernet Network. Web Based Management and Administration utilities provide easy configuration and management of your Brother machine. Once installed and configured, the NC-9100h allows your machine to FAX documents over the Internet; print and scan documents over a network. The NC-9100h is even supplied with Brother's Peer to Peer printing software allowing you to easily share the machine as a small department printer.

## Features

### Internet Fax

The Brother machine can be assigned an E-mail address allowing you to send, receive and forward documents on a Local Area Network and the Internet to PC's or other Internet Fax machines.



SMTP/POP3 mail server support.

### Network Printing

The Print / Fax server can be utilized as a print server providing printing services for the Windows® 95/98/Me, Windows NT® 4.0/2000/XP, Unix Systems supporting the TCP/IP protocols, Novell Operating Systems supporting IPX/SPX and Macintosh Networks supporting AppleTalk or TCP/IP.

### Network Scanning

You can scan documents into a PC on your Network directly or the Brother machine can E-mail them to your PC for editing in Black & White or Color.

### Management Utilities

The Web Based Management and BRAdmin Professional utilities provide powerful easy to use management of Fax, network and E-mail settings.

# **IMPORTANT INFORMATION: REGULATIONS**

---

## **Federal Communications Commission (FCC) Declaration of Conformity (For U.S.A. only)**

Responsible Party: Brother International Corporation  
100 Somerset Corporate Boulevard  
Bridgewater, NJ 08807-0911, USA  
TEL: (908) 704-1700

declares, that the products

Product Name: Brother Network Card (BR-net)  
Model Number: NC-9100h

complies with Part 15 of the FCC Rules. Operation is subject to the following two conditions: (1) This device may not cause harmful interference, and (2) this device must accept any interference received, including interference that may cause undesired operation.

This equipment has been tested and found to comply with the limits for a Class B digital device, pursuant to Part 15 of the FCC Rules. These limits are designed to provide reasonable protection against harmful interference in a residential installation. This equipment generates, uses, and can radiate radio frequency energy and, if not installed and used in accordance with the instructions, may cause harmful interference to radio communications. However, there is no guarantee that interference will not occur in a particular installation. If this equipment does cause harmful interference to radio or television reception, which can be determined by turning the equipment off and on, the user is encouraged to try to correct the interference by one or more of the following measures:

- Reorient or relocate the receiving antenna.
- Increase the separation between the equipment and receiver.
- Connect the equipment into an outlet on a circuit different from that to which the receiver is connected.
- Consult the dealer or an experienced radio/TV technician for help.

### **Important**

Changes or modifications not expressly approved by Brother Industries, Ltd. could void the user's authority to operate the equipment.

## **Industry Canada Compliance Statement (For Canada only)**

This Class B digital apparatus complies with Canadian ICES-003.

Cet appareil numérique de la classe B est conforme a la norme NMB-003 du Canada.

## Declaration of Conformity (Europe)

We, Brother Industries, Ltd.,  
15-1, Naeshiro-cho, Mizuho-ku, Nagoya 467-8561, Japan

declare that this product is in conformity with the following normative documents.

Safety: EN 60950,  
EMC: EN 55022 Class B, EN 55024

following the provisions of the Low Voltage Directive 73/23/EEC and the Electromagnetic Compatibility Directive 89/336/EEC (as amended by 91/263/EEC and 92/31/EEC).

Issued by: Brother Industries, Ltd.  
Information & Document Company

## Caution for LAN connection

Connect this product to a LAN connection that is not subjected to overvoltages.

## Intel Copyright and License Information

This products includes object code from Intel's UPnP SDK.  
The following is the copyright and licensing information for Intel UPnP SDK.

Copyright© 2000 Intel Corporation

All rights reserved.

Redistribution and use in source and binary forms, with or without modification, are permitted provided that the following conditions are met:

- \* Redistributions of source code must retain the above copyright notice this list of conditions and the following disclaimer.
- \* Redistributions in binary form must reproduce the above copyright notice, this list of conditions and the following disclaimer in the documentation and/or other materials provided with the distribution.
- \* Neither name of Intel Corporation nor the names of its contributors may be used to endorse or promote products derived from this software without specific prior written permission.

THIS SOFTWARE IS PROVIDED BY THE COPYRIGHT HOLDERS AND CONTRIBUTORS "AS IS" AND ANY EXPRESS OR IMPLIED WARRANTIES, INCLUDING, BUT NOT LIMITED TO, THE IMPLIED WARRANTIES OF MERCHANTABILITY AND FITNESS FOR A PARTICULAR PURPOSE ARE DISCLAIMED. IN NO EVENT SHALL INTEL OR CONTRIBUTORS BE LIABLE FOR ANY DIRECT, INDIRECT, INCIDENTAL, SPECIAL, EXEMPLARY, OR CONSEQUENTIAL DAMAGES (INCLUDING, BUT NOT LIMITED TO, PROCUREMENT OF SUBSTITUTE GOODS OR SERVICES; LOSS OF USE, DATA, OR PROFITS; OR BUSINESS INTERRUPTION) HOWEVER CAUSED AND ON ANY THEORY OF LIABILITY, WHETHER IN CONTRACT, STRICT LIABILITY, OR TORT (INCLUDING NEGLIGENCE OR OTHERWISE) ARISING IN ANY WAY OUT OF THE USE OF THIS SOFTWARE, EVEN IF ADVISED OF THE POSSIBILITY OF SUCH DAMAGE.

# Table of Contents

---

Introduction .....	iii
Overview .....	iii
Features .....	iii
IMPORTANT INFORMATION: REGULATIONS.....	iv
Federal Communications Commission (FCC)	
Declaration of Conformity (For U.S.A. only) .....	iv
Industry Canada Compliance Statement	
(For Canada only).....	iv
Declaration of Conformity (Europe) .....	v
Caution for LAN connection.....	v
Intel Copyright and License Information .....	v

## 1

<b>Unix Printing.....</b>	<b>1-1</b>
Printing from Unix/Linux Using TCP/IP .....	1-1
Overview .....	1-1
TCP/IP .....	1-2
General TCP/IP UNIX Host Configuration .....	1-2
Linux Configuration .....	1-6
Linux Configuration Using CUPS .....	1-6
HP-UX Configuration .....	1-7
IBM RS/6000 AIX Configuration .....	1-8
Sun Solaris 2.x Configuration .....	1-9
SCO UNIX Configuration .....	1-10
IBM AS/400 .....	1-11
Other Systems.....	1-12
Other Sources of Information.....	1-13

## 2

<b>TCP/IP Printing.....</b>	<b>2-1</b>
Printing from Windows NT® 4.0, Windows® 2000/XP, LAN Server and Warp Server .....	2-1
Overview .....	2-1
Windows NT® 4.0 and Windows® 2000/XP (TCP/IP)	
Configuration .....	2-2
Windows® 2000/XP Printing	
(Printer Driver not yet installed) .....	2-2
Standard TCP/IP Port Printing.....	2-2
Windows® 2000/XP Printing	
(Printer Driver already installed) .....	2-4
Windows NT® 4.0 Printing .....	2-4
Windows NT® 4.0 Printing	
Installing the Brother Peer to Peer Software .....	2-5

Windows NT® 4.0 Printing	
Associating to the Printer.....	2-6
Windows NT® 4.0 Printing	
Adding a Second Brother LPR Port.....	2-7
Other Sources of Information .....	2-7

<b>3</b>	<b>Peer to Peer Printing .....</b>	<b>3-1</b>
	How to Print in a Windows® 95/98/Me Peer to Peer network.....	3-1
	Overview.....	3-1
	Quick Tips: .....	3-1
	Driver Deployment Wizard .....	3-2
	TCP/IP Printing.....	3-2
	Installing the Brother Peer to Peer Software .....	3-2
	Associating to the Printer.....	3-3
	Adding a Second Brother LPR Port.....	3-5
	Other Sources of Information .....	3-5

<b>4</b>	<b>NetBIOS Peer to Peer Printing.....</b>	<b>4-1</b>
	How to Print Using NetBIOS in Windows® 95/98/Me/2000/XP, Windows NT®4.0, LAN Server and OS/2 Warp Server .....	4-1
	Overview.....	4-1
	Print Server Configuration .....	4-2
	Changing the workgroup/domain name using a web browser .....	4-3
	NetBIOS Port Monitor for Windows® 95/98/Me/2000/XP and Windows NT® 4.0 .....	4-4
	Installing the Brother NetBIOS Port Monitor.....	4-4
	Associating the Printer.....	4-5
	Windows® 95/98/Me .....	4-5
	Windows NT® 4.0 / Windows® 2000/XP .....	4-6
	Adding a Second NetBIOS Print Port.....	4-7
	Windows® 95/98/Me .....	4-7
	Windows NT® 4.0 / Windows® 2000/XP .....	4-8
	Other Sources of Information .....	4-8

<b>5</b>	<b>Configuring Internet Printing for Windows® .....</b>	<b>5-1</b>
	Internet Printing Installation .....	5-1
	Overview.....	5-1
	Brother Internet Print General Information .....	5-2
	Brother Internet Print: Configuring the Brother Print/Fax Server .....	5-3
	Print Server Configuration Checklist .....	5-3



Brother Internet Print: Using BRAdmin Professional utility to Configure the Print Server .....	5-4
Brother Internet Print: Using a Web Browser to Configure the Print Server .....	5-5
Brother Internet Print: Installing the BIP software on Windows® 95/98/Me/2000/XP and Windows NT® 4.0 ....	5-6
Setup from CD-ROM .....	5-6
Adding a Second Brother Internet Port.....	5-9
Windows® 2000/XP IPP Printing .....	5-9
Specifying a Different URL .....	5-11
Other Sources of Information.....	5-11

## 6

<b>Novell NetWare Printing .....</b>	<b>6-1</b>
How to Configure Novell NetWare Printing.....	6-1
Overview.....	6-1
General Information .....	6-2
Creating a NDPS Printer Using NWADMIN for NetWare5.....	6-3
NDPS Manager.....	6-3
NDPS Broker .....	6-4
Creating a Printer Agent .....	6-5
Configuring NetWare 3 and NetWare 4 systems.....	6-6
Creating a Network Print Server (Bindery Queue Server) using BRAdmin Professional utility.....	6-6
Creating a Network Print Server (NDS Queue Server) using BRAdmin Professional utility.....	6-8
Creating a Network Print Server (NDS Queue Server) using Novell NWADMIN and BRAdmin Professional utility .....	6-9
Creating a Network Print Server (NDS Remote Printer) using Novell NWAdmin and BRAdmin Professional utility .....	6-12
Other Sources of Information.....	6-13

## 7

<b>Printing from a Macintosh® .....</b>	<b>7-1</b>
Printing from a Macintosh® Using AppleTalk® and TCP/IP or Simple Network Configuration capabilities.....	7-1
Overview.....	7-1
Macintosh® Configuration (Mac OS® 8.6 - 9.2).....	7-2
How to Select the Print Server (AppleTalk/EtherTalk) .....	7-3
How to Select the Print Server (TCP/IP).....	7-5
Macintosh Configuration (Mac OS® X 10.1-10.2.1 or greater) .....	7-7

	How to Select the Print Server (AppleTalk/EtherTalk).....	7-8
	How to Select the Print Server (TCP/IP) .....	7-9
	Changing the Configuration.....	7-10
	Other Sources of Information .....	7-10
	Printing from a Macintosh® using Simple Network Configuration capabilities of Mac OS® X.....	7-10
<b>8</b>	<b>DLC Printing.....</b>	<b>8-1</b>
	Printing from Windows NT® 4.0 or Windows® 2000 .....	8-1
	Overview.....	8-1
	Configuring DLC on Windows NT® 4.0 and Windows® 2000.....	8-1
	Windows® 2000 Printer Setup .....	8-2
	Windows NT® 4.0 Printer Setup .....	8-3
	Configuring DLC on Other Systems .....	8-4
	Other Sources of Information .....	8-5
<b>9</b>	<b>Web Based Management .....</b>	<b>9-1</b>
	How to use a Web Browser to manage your Device .....	9-1
	Overview.....	9-1
	How to connect to your machine using a Browser .....	9-2
	Password Information.....	9-2
	Other Sources of Information .....	9-2
<b>10</b>	<b>Front Panel Setup Menu.....</b>	<b>10-1</b>
	LAN Main Setup Menu .....	10-1
	Setup TCP/IP.....	10-2
	BOOT Method .....	10-2
	IP Address.....	10-5
	Subnet Mask .....	10-5
	Gateway .....	10-6
	Host Name .....	10-6
	WINS CONFIG.....	10-7
	WINS Server .....	10-7
	DNS Server .....	10-8
	APIPA.....	10-9
	Setup Internet (For MFC only).....	10-10
	Mail Address.....	10-10
	SMTP Server.....	10-11
	POP3 Server .....	10-11
	Mailbox Name .....	10-12
	Mailbox Pwd .....	10-12
	Setup Mail RX (For MFC only) .....	10-13
	Auto Polling .....	10-13

Poll Frequency.....	10-13
Header.....	10-13
Del Error Mail.....	10-14
Notification.....	10-14
Setup Mail TX (For MFC only).....	10-15
Sender Subject.....	10-15
Size Limit.....	10-15
Notification.....	10-16
Setup Relay (For MFC only).....	10-17
Rly Broadcast.....	10-17
Relay Domain.....	10-17
Relay Report.....	10-18
Setup Misc.....	10-19
Netware.....	10-19
Net Frame.....	10-19
AppleTalk.....	10-19
DLC/LLC.....	10-20
Net BIOS/IP.....	10-20
Ethernet.....	10-20
Time Zone.....	10-21
User Setting List (For MFC only).....	10-22
Setup Scan to E-mail (For MFC only).....	10-22
Color File Type for Scan to E-mail.....	10-22
Black and White File Type for Scan to E-mail.....	10-22

## **11**

<b>TCP/IP Configuration.....</b>	<b>11-1</b>
Assigning TCP/IP Information.....	11-1
Overview.....	11-1
Using the machine control panel to allocate an IP address (Models with LCD panels only).....	11-2
Changing the IP Address using the BRAdmin Professional utility.....	11-2
Using BRAdmin Professional utility and the IPX/SPX Protocol to set the IP address.....	11-3
Using BRAdmin Professional utility and the TCP/IP Protocol to set the IP address.....	11-4
Using DHCP to Configure the IP address.....	11-5
Using APIPA to Configure the IP Address.....	11-5
Using ARP to Configure the Print/Fax Server IP Address.....	11-6
Using RARP to Configure the IP Address.....	11-8
Using BOOTP to Configure the IP Address.....	11-9

<b>12</b>	<b>Internet FAX (MFC Only) .....</b>	<b>12-1</b>
	Overview.....	12-1
	Getting Connected .....	12-2
	Front Panel Key Functions .....	12-2
	Sending an Internet Fax .....	12-3
	Manually Entering Text.....	12-3
	Receiving E-mail or Internet Fax .....	12-5
	Receiving an Internet Fax to a PC.....	12-6
	Forwarding Received E-mail and Fax Messages.....	12-6
	Relay Broadcasting .....	12-7
	Relay Broadcast from a MFC .....	12-7
	Relay Broadcast from a PC .....	12-9
	TX Verification Mail.....	12-9
	Setup Mail (TX).....	12-10
	Setup Mail (RX) .....	12-10
	Error mail.....	12-11
	Important information on Internet Fax .....	12-11

<b>13</b>	<b>Troubleshooting .....</b>	<b>13-1</b>
	Overview.....	13-1
	Installation problems.....	13-1
	Resetting the Print/Fax Sever back to factory settings (Test Switch) .....	13-4
	Intermittent Problems .....	13-4
	TCP/IP Troubleshooting .....	13-5
	UNIX Troubleshooting .....	13-5
	Windows NT® 4.0/LAN Server (TCP/IP) Troubleshooting.....	13-7
	Windows® 95/98/Me Peer to Peer Print (LPR) Troubleshooting .....	13-7
	Windows® 95/98/Me Peer-to-Peer (HP JetAdmin compatible method) Troubleshooting .....	13-8
	Windows® 95/98/Me/2000/XP and Windows NT® 4.0 Peer-to-Peer Print (NetBIOS) Troubleshooting .....	13-8
	Brother Internet Print (TCP/IP) Troubleshooting .....	13-9
	Windows® 95/98/Me/2000/XP IPP Troubleshooting.....	13-9
	Novell NetWare Troubleshooting.....	13-10
	AppleTalk Troubleshooting.....	13-11
	DLC/LLC Troubleshooting.....	13-12
	Web Browser Troubleshooting (TCP/IP) .....	13-12
	Internet Fax Troubleshooting.....	13-13

<b>14</b>	<b>Brother Internet Fax Printing Software.....</b>	<b>14-1</b>
	Overview.....	14-1
	Installing Brother Internet Fax Printing Driver.....	14-2
	Changing the BFP Port Settings.....	14-4
	Relay Broadcast Function.....	14-5
	Uninstalling from Windows® 95/98/Me/2000/XP and Windows NT® 4.0 .....	14-7
	Using the BFP Address Book .....	14-9
	Setting Up a Member in the Address Book .....	14-9
	Setting Up a Group for Broadcasting.....	14-10
	Editing Member Information .....	14-11
	Exporting the Address Book.....	14-11
	Sending a Network Fax with BFP .....	14-12

<b>A</b>	<b>Appendix.....</b>	<b>A-1</b>
	Appendix A .....	A-1
	General Information.....	A-1
	BRAdmin Professional utility (Recommended).....	A-1
	Web BRAdmin .....	A-1
	HTTP (Recommended) .....	A-2
	WebJetAdmin .....	A-2
	Appendix B .....	A-3
	Using Services.....	A-3
	General.....	A-3
	Appendix C .....	A-4
	Reloading the Print / FAX Server Firmware.....	A-4
	General.....	A-4
	Reloading firmware using BRAdmin Professional utility .....	A-5
	Reloading using the FTP Protocol from a command prompt .....	A-6
	Appendix D .....	A-8
	Updating other MFC's through the Network .....	A-8
	Appendix E .....	A-11
	Specifications.....	A-11
	Function Table and Default Factory Settings.....	A-14

<b>I</b>	<b>INDEX.....</b>	<b>I-1</b>
----------	-------------------	------------

# 1 Unix Printing

## Printing from Unix/Linux Using TCP/IP

---

### Overview

---

Brother Print/Fax servers are supplied with the Transmission Control Protocol/Internet Protocol (TCP/IP) protocol suite. Since virtually all UNIX host computers support TCP/IP, this capability allows a printer to be shared on a UNIX Ethernet network. As with all protocols, TCP/IP communications can proceed concurrently while other protocols are active, this means that UNIX, NetWare, Apple, and other computers can share the same Brother print server over an Ethernet network.

The Linux operating system uses the same setup procedures as standard Berkeley UNIX systems. Refer to this chapter for a typical GUI based Linux installation.

### Quick Tips:

- 1 The Automatic Private IP Addressing (APIPA) protocol automatically assigns an IP address from the range: 169.254.1.0 to 169.254.254.255. If you want to disable the APIPA protocol, set APIPA to Off using the machine control panel. For more information, see *APIPA* on page 10-9. If the APIPA protocol is disabled, the default IP address of a Brother Print/Fax server is 192.0.0.192. To change it, use the control panel, the BRAdmin Professional utility, Web BRAdmin software or let your DHCP server allocate an IP address to the machine.
- 2 To learn how to configure the IP address on your machine, see *Chapter 11* of this User's Guide.
- 3 The default password for Brother Print/Fax servers is `access`.
- 4 The default name for a Brother Print/Fax server is usually `BRN_XXXXXX` (where `XXXXXX` is the last six digits of the Ethernet address of the Print/Fax server).

- 5 When configuring the PRINTCAP file, pay particular attention to the service names, BINARY\_P1 and TEXT\_P1.

## TCP/IP

---

Brother Print/Fax servers appear to the network as a UNIX host computer with a unique IP address running the lpd (line printer daemon) protocol. As a result, any host computer that supports the Berkeley remote LPR command can spool jobs to Brother print servers without the need for any special software on the host computer. For special applications, raw TCP ports are also available.

Brother Print/Fax servers also support the FTP protocol. This protocol can be used to send print jobs from Unix systems.

The Brother Print/Fax server is pre-configured to run on a TCP/IP network with a minimum of setup. The only mandatory configuration of the Print/Fax server is the allocation of an IP address, which can be either automatically assigned using DHCP, BOOTP etc., or manually assigned using the ARP command, BRAdmin Professional utility, or the machine control panel.



For setting the IP address of the Print/Fax server, see *Chapter 11* of this User's Guide or the Quick Setup Guide

## General TCP/IP UNIX Host Configuration

---

The configuration process for most UNIX systems is described in the following steps. As this process varies, we recommend that you refer to your system documentation for additional information.

- 1 Configure the `/etc/hosts` file on each UNIX host that needs to communicate with the Print/Fax server. Use your favorite editor to add an entry to the `/etc/hosts` file containing the IP address and node name of the device. For example:

```
192.189.207.3      BRN_310107
```

The actual format of the entry may vary depending on your system, check your system documentation and also note the format of other entries in the `/etc/hosts` file.



The node name in this file does not necessarily need to be the same as the one that is actually configured into the Brother Print/Fax server (the name that appears on the printer configuration page), however, it is good practice to make the names the same. Some operating systems, such as HP-UX, do not accept the “\_” character in the default name, for these systems you must use a different name).

In any case, the node name in the `/etc/hosts` file must match the node name in the `/etc/printcap` file.

Some systems such as HP-UX and AIX allow you to enter the IP address as the host name when setting up the print queue. If this is the case, you do not need to configure the hosts file.

- 2 Choose which Print/Fax server service you want to use. There are several types of services available on Brother Print/Fax servers. Binary services pass data through unmodified and are therefore required for PCL or PostScript rasterized graphics printouts. Text services add a carriage return at the end of each line for proper formatting of UNIX text files (which end in linefeed and do not have carriage returns). The text service can also be used for non-rasterized graphics, such as ASCII PostScript graphics or many types of PCL graphics.

Choose one of the available services (a service name will be used in step 3):

BINARY\_P1 Binary data  
TEXT\_P1 Text data (CR added)

You may set up multiple print queues on your UNIX host computer for the same Print/Fax server, each one with a different service name (for example, one queue for binary graphics jobs and one for text jobs).



- 3 Configure the `/etc/printcap` file on each host computer to specify the local print queue, the Print/Fax server name (also called remote machine or `rm`), and the Print/Fax server service name (also called remote printer, remote queue, or `rp`), and the spool directory.



This step applies to the majority of UNIX systems, including Linux, Sun OS (but not Solaris 2.xx), Silicon Graphics (`lpr/lpd` option required), DEC ULTRIX, DEC OSF/1, and Digital UNIX. SCO UNIX users should follow these steps, but should also see *SCO UNIX Configuration* on page 1-10 section. Users of RS/6000 AIX, HP-UX, Sun Solaris 2.xx, and other systems that do not use the `printcap` file should skip to Step 4. SCO user's should also skip to Step 4 (SCO uses the `printcap` file, but this file is automatically configured via the `rlpconf` command).

An example of a typical `printcap` file:

```
laser1|Printer on Floor 1:\
:lp=: \
:rm=BRN_310107:\
:rp=TEXT_P1:\
:sd=/usr/spool/lpd/laser1:
```



Make sure this information is added to the end of the `printcap` file. Also make sure that the last character in the `printcap` file is a colon “:”.

This will create a queue named `laser1` on the host computer that communicates to a Brother print server with a node name (`rm`) of `BRN_310107` and a service name (`rp`) of `TEXT_P1` printing text files to a Brother printer through spool directory `/usr/spool/lpd/laser1`. If you are printing binary graphics files, you would use the service `BINARY_P1` instead of `TEXT_P1`.



The `rm` and `rp` options are not available on some UNIX systems, so if necessary check your documentation to determine the equivalent options.

Users of Berkeley-compatible UNIX systems can use the `lpc` command to obtain the printer status:

```
%lpc status
laser1:
queuing is enabled
printing is enabled
no entries
no daemon present
```

Users of AT&T-compatible UNIX systems can generally use the `lpstat` or `rlpstat` commands to obtain similar status information. Because this procedure varies from system to system, refer to your system documentation for the exact usage.

- 4 Skip this section if you have completed Step 3, unless you have an SCO UNIX system.

If you have an HP-UX system, IBM RS/6000 AIX computer, or Sun Solaris 2.xx, there is no `printcap` file. This is also true for some other AT&T-based UNIX systems, as well as many VMS-based TCP/IP software packages (for example, UCX, TGV Multinet, etc.). On SCO systems, there is a `printcap` file, but it is automatically configured by the `rlpconf` command. Most of these systems generally use a printer setup program to define the service name (remote printer), the print server name (remote machine) or IP address, and the local queue name (spool directory). Refer to the appropriate section depending on your version of Unix.

# Linux Configuration

---

If you do not wish to use the command line interface to configure your Linux distribution, you may wish to use the Linux Printer System Manager application on your GUI. To do this, do the following:

- 1 From the Linux Printer System Manager screen, click the **Add** button.
- 2 You will now be asked to specify which Printer type you are using, select the **Remote Unix (lpd) Queue** option and click **OK**.
- 3 You must now specify the remote host name, remote queue name and the input filter to use.
- 4 The **Remote Host** name is the IP address of the printer, or the name from the hosts file which corresponds to the IP address of the printer.
- 5 The **Remote Queue** name is the service name that the printer will use when processing the data. Generally we recommend that you use the name "BINARY\_P1", however, if you are planning to send text documents that do not have a carriage return and a line feed, then use "TEXT\_P1".
- 6 Select the appropriate **Input Filter** from the list of available printers on your particular build of Linux.

In order to make your settings work, select the **Restart lpd** option. As soon as the lpd server restarts, you will be able to send printed documents from your server.

## Linux Configuration Using CUPS

Many Linux systems support Common Unix Printing System (CUPS).

## HP-UX Configuration

---

In the case of HP-UX10.xx, the sam program is used to set up the remote printer. The steps are as follows:

- 1 Execute the sam program. From the list of options, select **Printers and Plotters**.
- 2 Select **LP Spooler**.
- 3 Select **Printers and Plotters**.
- 4 Select **Actions** and then **Add Remote Printer/Plotter**.
- 5 Enter any name as the **Printer Name** (this will be the name of the print queue).
- 6 Enter the IP address of the Print/Fax server as the **Remote System Name**.
- 7 Enter the desired Print/Fax server service name as the **Remote Printer Name**.
- 8 Check the box next to **Remote Printer is on BSD system**.
- 9 You may accept the default values for the remaining items.
- 10 Click **OK** to configure the printer.

You should now be able to print using the lp-d command with the printer name.

If you are using the HP distributed print service, the configuration procedure is slightly different because you are sending the print jobs to a file server, which in turn spools the job to the Print/Fax server. You must therefore know the name of the file server (spooler host) in addition to the above information. You will add a physical and a remote printer, and then assign a logical printer to the remote printer (a unique name that does not match any other name). To print, use the lp -d command with the logical printer name.

Earlier versions of HP-UX use similar procedures to 10.xx users:

- 1 Enter **sam** and select **Peripheral Devices** and then **Add Remote Printer (not Networked printer)**.
- 2 Enter the following remote printer settings (the other settings do not matter):
  - **Line printer name** (user-selectable).
  - **Remote system name** (the Print/Fax server name; must match what is in hosts file or use Print/Fax server IP address).
  - **Remote printer queue** (Print server binary or text service name, e.g. BINARY\_P1 or TEXT\_P1).
  - **Remote Printer is on a BSD System** (Yes).

## IBM RS/6000 AIX Configuration

---

The RS/6000 AIX operating system uses the smit program to set up the remote printer. The procedure is as follows for AIX 4.0 and later:

- 1 Enter **smit** and select **devices**.
- 2 Select **Printer/Plotter**.
- 3 Select **Print Spooling**.
- 4 Select **Add a Print Queue**.
- 5 Select **Remote**.
- 6 Enter the following Remote Printer Settings:

**Name of queue** (user selectable)

**Host name of Remote Printer** (Print/Fax server name; must match name in `/etc/hosts` file or use the print server IP address)

**Name of queue on remote printer** (Print/Fax server binary or text service name, eg. BINARY\_P1 or TEXT\_P1).

**Type of print spooler**. BSD (press the LIST button and choose BSD)

The procedure for pre-V4.0 systems is as follows.

- 1 Enter `smit` and select **devices**.
- 2 Select **printer/plotter**.
- 3 Select **manage remote printer subsystem**.
- 4 Select **client services**.
- 5 Select **remote printer queues**.
- 6 Select **add a remote queue**.
- 7 Enter the following remote queue settings:
  - **Name of queue to add** (user selectable).
  - **Activate the queue (Yes)**.
  - **Destination host** (Print/Fax server name; must match name in `/etc/hosts` file or use the Print/Fax server IP address)
  - **Name of queue on remote printer** (Print/Fax server binary or text service name, eg. `BINARY_P1` or `TEXT_P1`).
  - **Name of device to add** (user selectable; for example `lp0`).

## Sun Solaris 2.x Configuration

---

Sun Solaris 2.x uses the `lpsystem` and `lpadmin` programs for remote printer configuration:

```
lpsystem -t bsd prnservername
lpadmin -p queue -s prnservername!prnserver-service
accept queue      (not required on newer Solaris systems)
enable queue      (not required on newer Solaris systems)
```

Where `queue` is the name of the local Print/Fax queue.

`prnservername` is the name of the Print/Fax server (must match the entry in the `/etc/hosts` file or IP address).

`prnserver-service` is the print server `BINARY_P1` or `TEXT_P1` service.

If this is the first printer configured, you must also use the `lpsched` command prior to the `accept` command.

As an alternative, you may use Printer Manager in the Admintool utility under OpenWindows. Select **Edit, Add, and Add Access to Remote Printer**. Then enter the Print/Fax server name in the format `prnservername!\prnserver` as described above. Make sure that the printer server OS is set to **BSD** (the default setting), and click **Add**.

Note that we recommend that you use the `/etc/hosts` file for the printer name rather than NIS or other name services. Also note that due to a bug in the Sun lpd implementation on Solaris 2.4 and earlier releases, you may experience problems printing very long print jobs. If this is the case, a workaround is to use the raw TCP port software as described later in this chapter.

## SCO UNIX Configuration

---

To configure a printer in version Version 5.x of SCO Unix, use the SCOADMIN program.

- 1 Select **Printers** and then **Print Manager**.
- 2 On the menu select **Printer** and then **Add Remote** followed by **Unix...**
- 3 Enter the IP address of the Print/Fax server, and type in the name of the printer that will be used to spool to.
- 4 Deselect **Use External remote Printing Protocol...**
- 5 To eject the printed page, add the command `rp=lpaf` to the `/etc/printcap` file.

SCO UNIX requires TCP/IP V1.2 or later to work with Brother print servers. You must first configure the `/etc/hosts` and `/etc/printcap` files as described in step 2. Then run the `sysadmsh` program as follows:

- 1 **Select Printers.**
- 2 **Select Configure.**
- 3 **Select Add.**
- 4 Enter the name of the print queue you entered in the `/etc/printcap` file as the **Printer name**.
- 5 Enter anything as the **Comment**, and **Class name**.
- 6 For the **Use printer interface** select **Existing**.
- 7 Press the F3 key to get a list of available interfaces, and select the desired one as the **Name of interface** using the cursor keys (`Dumb` is a good choice).
- 8 Select **Direct** as the **Connection**.
- 9 Enter the desired Device name (`/dev/lp` generally works).
- 10 Select **Hardwired** as the **Device**.
- 11 Select **No** for the **Require banner** field.

### **Older SCO Unix Systems**

The Brother NC-9100h Print/Fax servers support the FTP protocol. Earlier SCO Unix systems are often configured to print using the FTP protocol.

## **IBM AS/400**

---

To use a Brother Print/Fax server with an IBM AS/400 running IBM's TCP/IP gateways services for OS/400 (the OS/400 system must be v3.1 or later)

Use the `CFGTCP` command at your OS/400 prompt to add the Print/Fax server's TCP/IP address to the AS/400 host table.



Use the following one-line OS/400 command to create the LPD queue:

```
CRTOUTQ OUTQ(<queuename> RMSTSYS
(*INTNETADR) RMTprtQ(<service>)
AUTOSTRWTR(1) CNNTYPE(*IP) DESTTYPE (*OTHER)
MFRTYPMDL (<driver>)
INTNETADR('<ipaddress>') TEXT
('<description>')
```

where <queuename> is the new AS/400 print queue name, <service> is the Print/Fax server service name (BINARY\_P1 or TEXT\_P1) <driver> is the OS/400 printer driver name (\*HP4 is recommended if in doubt), and <ipaddress> is the IP address of the Print/Fax server. Note that the IP address and description must be enclosed in single quotes.

## Other Systems

---

Other systems use similar programs to set up Print/Fax servers. These programs will generally ask for the following information:

<b>Requested information:</b>	<b>You should use:</b>
remote printer	Binary or Text service name
remote host computer name	Any name (must match the name in the printcap file, if any) or in some cases, you may enter the Print/Fax server IP address here
remote host IP address	IP address of Print/Fax server.

Technical support specialists for these companies can usually answer configuration questions if you provide them with the equivalent UNIX configuration information (tell them that the Print/Fax server looks like a remote UNIX host computer running the lpd line printer daemon).

If you have not created a spool directory for the Brother Print/Fax server on your UNIX host computer, you will need to do so now (the printer setup utilities in HP/UX, AIX, Solaris 2.xx, and other systems will automatically create the spool directory). The lpd spool directory is usually located in the `/usr/spool` directory (check with your system manager to see if the location is different for your system). To create a new spool directory, use the `mkdir` command. For example, to create a spool directory for the queue `laser1`, you would enter:

```
mkdir /usr/spool/lpd/laser1
```

On some systems it is also necessary to start the daemon. This is done on Berkeley-compatible UNIX systems with the `lpc start` command as shown in the following example:

```
lpc start laser1
```

## **Other Sources of Information**

---

To learn how to configure the IP address on your machine, see *Chapter 11* of this User's Guide.

# 2

# TCP/IP Printing

## Printing from Windows NT® 4.0, Windows® 2000/XP, LAN Server and Warp Server

---

### Overview

---

Users of Windows NT® 4.0 can print directly to a network-ready Brother machine using the TCP/IP protocol. Microsoft Windows NT® 4.0 users must install Microsoft's "TCP/IP Printing" protocol. Windows® 2000/XP users are able to send print jobs directly to the printer without installing any additional software. Brother's print server also supports transparent printing from IBM LAN Server and OS/2 Warp Server file servers, as well as from OS/2 Warp Connect workstations using the TCP/IP protocol.

### Quick Tips:

- 1 The Automatic Private IP Addressing (APIPA) protocol automatically assigns an IP address from the range: 169.254.1.0 to 169.254.254.255. If you want to disable the APIPA protocol, set APIPA to Off using the machine control panel. For more information, see *APIPA* on page 10-9. If the APIPA protocol is disabled, the default IP address of a Brother Print/Fax server is 192.0.0.192. To change it, use the control panel, the BRAdmin Professional utility, Web BRAdmin software or let your DHCP server allocate an IP address to the machine.
- 2 The default password for Brother Print/Fax servers is `access`.
- 3 Windows NT® 4.0 users must install the Microsoft "TCP/IP Printing" protocol.
- 4 Windows® 2000/XP users can print using TCP/IP using the standard Network Printing software and IPP protocol software built into any Windows® 2000/XP installation.

- 5 Windows® 95/98/Me users can send print jobs using the IPP protocol via a Windows® 2000/XP computer provided that the Microsoft Internet Print Services software is installed on the client PC, Internet Information Server (IIS) is installed and running on the Windows® 2000/XP computer and that the client PC is using version 4 or later of Microsoft Internet Explorer. For more information, see *Windows® 2000/XP IPP Printing* on page 5-9.
- 6 The default name for a Brother Print/Fax server is usually BRN\_XXXXXXX (where XXXXXX is the last six digits of the Ethernet address of the Print/Fax server).

## Windows NT® 4.0 and Windows® 2000/XP (TCP/IP) Configuration

---

If you have not already done so, install the TCP/IP protocol onto your Windows NT® 4.0 system. This is done via the **Network** icon in the **Control Panel** window of the Windows NT® 4.0 system (use the **Start** button on Windows NT® 4.0 to access the **Settings/Control Panel** menu). The default configuration of Windows® 2000/XP automatically installs the TCP/IP protocol. Refer to the appropriate section in this chapter for more information.

## Windows® 2000/XP Printing (Printer Driver not yet installed)

---

By default, Windows® 2000/XP systems install with all the necessary software required for you to be able to print. This chapter describes the two most commonly used configurations, Standard TCP/IP Port printing and IPP (Internet Printing Protocol). If you have already installed the printer driver, jump to the **printer driver already installed** section.

### Standard TCP/IP Port Printing

- 1 From the **Printers** folder select **Add Printer**. The **Add Printer Wizard** will now start. Click on **Next**.
- 2 Now select the **Local Printer** option and deselect the **Automatically detect and install my Plug and Play printer** option.

- 3 Click on **Next**.
- 4 You must now select the correct Network printing port. Select **Create a new port** and select **Standard TCP/IP Port** port from the pull-down window.
- 5 When you have done that click **Next**.
- 6 The **Add Standard TCP/IP Port Wizard** will now appear. Click the **Next** button.
- 7 Enter the IP address, or name of the printer you wish to configure. The Wizard will automatically enter the Port name information for you.
- 8 Click the **Next** button.
- 9 Windows® 2000/XP will now contact the printer that you specified. If you did not specify the correct IP address or name then you will receive an error message.
- 10 Click the **Finish** button to complete the Wizard.
- 11 Now that you have configured the port, you must specify which printer driver you wish to use. Select the appropriate driver from the list of supported printers. If you are using a driver supplied with the machine on CD-ROM then select the **Have Disk** option to browse to the CD-ROM. You can also click the **Windows Update** button to connect directly to Microsoft's support Web site to download printer drivers.
- 12 When the driver is installed, click the **Next** button.
- 13 Specify a name and click the **Next** button.
- 14 Now specify if you wish to share the printer, enter the share name and click **Next**.
- 15 Continue through the Wizard clicking the **Finish** button when complete.

## Windows® 2000/XP Printing (Printer Driver already installed)

---

If you have already installed the printer driver and wish to configure it for network printing, follow these steps:

- 1 Select the printer driver you wish to configure.
- 2 Select **File** and then choose **Properties**.
- 3 Click the **Ports** tab of the driver and click **Add Port**.
- 4 Select the port that you wish to use. Typically this would be **Standard TCP/IP Port**. Then click the **New Port...** button.
- 5 The **standard TCP/IP Port Wizard** will start. Follow the Step 6 to 10 in the *Standard TCP/IP Port Printing* section.

## Windows NT® 4.0 Printing

---

If you did not install the TCP/IP protocol during the installation of your Windows NT® 4.0 system (either workstation or server) follow these steps. If you have already installed the TCP/IP protocol, proceed to the next section.

- 1 Go to the **Start** button, choose **Settings**, and then select **Control Panel**.
- 2 Run the **Network** applet by double clicking the **Network** icon and then click on the **Protocols** tab.
- 3 Select **Add**, and double click on the **TCP/IP Protocol**.
- 4 Insert the requested disk(s), or CD-ROM, to copy the required files.
- 5 Click the **Close** button. The Windows NT® 4.0 system will review protocol bindings and then you will see the **TCP/IP Properties** dialog.

- 6 Configure the host IP address, subnet mask, and gateway address in that dialog. Consult your system manager for these addresses.
- 7 Click **OK** to exit (your Windows NT® 4.0 or server will need to be re-booted).

## Windows NT® 4.0 Printing

### Installing the Brother Peer to Peer Software

---

- 1 Start the CD-ROM installation menu program according to the Quick Setup Guide.
- 2 Select the desired Language and then select **Install Optional Applications**. Then select the **Network Print Software** installation program.
- 3 Click on **Next** in response to the Welcome message.
- 4 Select the **Brother Peer to Peer Print (LPR)** button.
- 5 Select the desired directory to install the **Brother Peer to Peer Print (LPR)** files and click on **Next**. The installation program will create the directory for you if it does not already exist on your disk.
- 6 Enter the Port name that you wish to use and click **OK**. The default port name is BLP1. Whichever name you choose, it must be unique and it **MUST** begin with BLP.
- 7 You must now enter the actual IP address of the print server in the IP Address field. If you have edited the hosts file on your computer or are using Domain Name System, you can also enter the name of the print server. As the print server supports TCP/IP and NetBIOS names, you can also enter the NetBIOS name of the print server. The NetBIOS name can be seen in the printer configuration page. By default the NetBIOS name will appear as BRN\_XXXXXX where XXXXXX is the last six digits of the Ethernet address.
- 8 Click the **OK** button. When prompted you must re-boot your computer.

## Windows NT® 4.0 Printing Associating to the Printer

---

You must now create a printer on your Windows® system using the standard Windows® printer setup procedure.

- 1 To do this, go to the **Start** button, select **Settings** and then **Printers**.
- 2 Double click the **Add Printer** icon to get the **Add Printer Wizard**.
- 3 Select **My Computer** (not Network Printer) and click on **Next**.
- 4 Select the Brother LPR Port (the port name you assigned in step 6 of the “Installing Brother Peer to Peer Software” section in this chapter) and click on Next.
- 5 Select the desired printer model. If the correct model is not displayed, click on the **Have Disk** option and insert the CD-ROM supplied with your printer.
- 6 If the driver already exists, select **Keep Existing Driver** (if it does not exist, this step will be skipped), and then click on **Next**.
- 7 If desired, change the name of the printer then click **Next**.
- 8 If desired, make the printer shared (so other user can access it), and select the operating system(s) that these other computers will be running. Click on **Next**.
- 9 Select **Yes** when you asked **Would you like to print a test page?** Click on **Finish** to complete the installation. You may now print to the printer as if it were a local printer.



## Windows NT® 4.0 Printing

### Adding a Second Brother LPR Port

---

You do not need to re-run the install program to add a new Brother LPR port. Instead, press the **Start** button, select **Settings**, and open the **Printers** window. Click on the icon of the printer that you wish to configure, select **File** from the menu bar, and then choose **Properties**. Click on the **Ports** tab and push the **Add Port** button. In the **Printer Ports** dialog, highlight **Brother LPR Port**. Click the **New Port** button and enter the port name. The default port name is BLP1. If you have already used this name, you will get an error message if you try to use it again, in which case use BLP2, etc... Once you have specified the port name, click the **OK** button. You will then see the **Port Settings** dialog.

Enter the IP address of the printer that you wish to print to and click **OK**. And then click **Close** in the **Printer Ports** dialog. You should now see the port that you have just created in the **Print to the following port(s)** setting of the printer driver.

### Other Sources of Information

---

To learn how to configure the IP address on your machine, see *Chapter 11* of this User's Guide.

# 3 Peer to Peer Printing

## How to Print in a Windows® 95/98/Me Peer to Peer network

---

### Overview

---

Microsoft's Windows® 95/98/Me operating systems feature built-in networking capabilities. These capabilities allow a Windows® PC to be configured as a client workstation in a file server based network environment.

For smaller networks, Windows® 95/98/Me also allows the PC to operate in a peer-to-peer mode. In this mode, the PC can share resources with other PCs on the network without the need for a central file server.

### Quick Tips:

- 1 The Automatic Private IP Addressing (APIPA) protocol automatically assigns an IP address from the range: 169.254.1.0 to 169.254.254.255. If you want to disable the APIPA protocol, set APIPA to Off using the machine control panel. For more information, see *APIPA* on page 10-9. If the APIPA protocol is disabled, the default IP address of a Brother Print/Fax server is 192.0.0.192. To change it, use the control panel, the BRAdmin Professional utility, Web BRAdmin software or let your DHCP server allocate an IP address to the machine.
- 2 To learn how to configure the IP address on your machine, see *chapter 11* of this User's Guide.
- 3 The default password for Brother Print/Fax servers is `access`.

## Driver Deployment Wizard

This installer includes the Windows® PCL driver and Brother network port driver (LPR and NetBIOS).

If the administrator then installs the printer driver and port driver using this software, he can save the file to the File server or send the file in E-mail to users. Then, each user just clicks that file to have the printer driver, port driver, IP address, and so on, automatically copied to their PC.

For more information, see the Driver Deployment Wizard User's Guide on the CD-ROM.

## TCP/IP Printing

---

Our Peer to Peer printing software requires the TCP/IP protocol to be installed on your Windows® peer-to-peer computers and an IP Address has to be defined for the Print/Fax server. Refer to your Windows® documentation for more information on how to configure the TCP/IP protocol on your Windows® PC.

If you haven't already done so, configure the IP address of the machine, for more information on IP address configuration, see *chapter 11* of this User's Guide.

## Installing the Brother Peer to Peer Software

---



If you already installed the driver from the printer's CD-ROM Installer and you selected "Brother Peer-to-Peer Network Printer" during the installation then you do not need to install the Brother Network Print Software again.

- 1 Start the CD-ROM installation menu program according to the Quick Setup Guide.
- 2 Select the proper model and then the **Install Optional Applications** menu. Then select **Network Print Software** installation program.
- 3 Push the **Next** button in response to the Welcome message.
- 4 Select the **Brother Peer to Peer Print (LPR)** button.

- 5 Select the desired directory to install the **Brother Peer to Peer Print (LPR)** files and push **Next**. The installation program will create the directory for you if it does not already exist on your disk.
- 6 Enter the **Port name** that you wish to use and click **OK**. The default port name is BLP1. Whichever name you choose, it must be unique and it **MUST** begin with BLP.
- 7 You must now enter the actual IP address of the Print/Fax server in the **Printer name or IP address** field. If you have edited the hosts file on your computer or are using Domain Name System, you can also enter the name of the print server. As the Print/Fax server supports TCP/IP and NetBIOS names, you can also enter the NetBIOS name of the Print/Fax server. The NetBIOS name can be seen in your printer settings page. By default the NetBIOS name will usually appear as BRN\_XXXXXXX where XXXXXXX is the last six digits of the Ethernet address.



Windows® 95/98/Me store the hosts file in the default Windows® directory. By default, the Windows® hosts file is called `hosts.sam`. If you wish to use the hosts file you must rename the file to `hosts` with no extension. The `.sam` extension stands for sample.

- 8 Click the **OK** button. When prompted you must re-boot your computer.

## Associating to the Printer

---

You must now create a printer on your Windows® system using the standard Windows® printer setup procedure.

- 1 To do this, go the **Start** button, select **Settings** and then **Printers**.
- 2 Select **Add Printer** to begin the printer installation.
- 3 Click **Next** when you get the **Add Printer Wizard** window.

- 4 Select **Local Printer** when you are asked how the printers are connected to your computer, and then push **Next**.
- 5 Select the correct driver. Click **Next** when you are done.
- 6 If you have selected a printer driver that is already being used, you have the option of either keeping the existing driver (recommended) or replacing it. Select the desired option and press **Next**.
- 7 Select the Brother LPR port (the port name you assigned in step 6 of the “Installing the Brother Peer to Peer Software” section) and press **Next**.
- 8 Enter any desired name for the Brother printer and press **Next**. For example, you could call the printer “Networked Brother Printer”.
- 9 Windows® will now ask you if you wish to print out a test page, select **Yes** and then select **Finish**.

You have now finished installing the Peer to Peer Print (LPR) software.

## Adding a Second Brother LPR Port

---

You do not re-run the install program to add a new Brother LPR port. Instead, press the **Start** button, select **Settings**, and open the **Printers** window. Click on the icon of the printer that you wish to configure, select **File** from the menu bar, and then choose **Properties**. Click on the **Details** tab and push the **Add Port** button. In the **Add Port** dialog, select the **Other** radio button and then highlight **Brother LPR port**. Click **OK** and enter the port name. The default port name is BLP1. If you have already used this name, you will get an error message if you try to use it again, in which case use BLP2, etc... Once you have specified the port name, click the **OK** button. You will then see the **Port Properties** dialog.

Enter the IP address of the printer that you wish to print to and click **OK**. You should now see the port that you have just created in the **Print to the following port** setting of the printer driver.

## Other Sources of Information

---

- 1 Visit <http://solutions.brother.com/> for more information on network printing.
- 2 To learn how to configure the IP address on your machine, see *chapter 11* of this User's Guide.

# 4

# NetBIOS Peer to Peer Printing

## How to Print Using NetBIOS in Windows® 95/98/Me/2000/XP, Windows NT® 4.0, LAN Server and OS/2 Warp Server

.....

### Overview

---

Brother Print/Fax server range supports SMB (Server Message Block) over the TCP/IP protocol via the NetBIOS interface. This means that just like regular Windows® PC's, Brother printers can appear in your network neighborhood. The main advantage of NetBIOS printing is that you are able to print from legacy DOS applications that are running on PC's that are connected to Microsoft networks.

### Quick Tips:

- 1 The Automatic Private IP Addressing (APIPA) protocol automatically assigns an IP address from the range: 169.254.1.0 to 169.254.254.255. If you want to disable the APIPA protocol, set APIPA to Off using the machine control panel. For more information, see *APIPA* on page 10-9. If the APIPA protocol is disabled, the default IP address of a Brother Print/Fax server is 192.0.0.192. To change it, use the control panel, the BRAdmin Professional utility, Web BRAdmin software or let your DHCP server allocate an IP address to the machine.
- 2 To learn how to configure the IP address on your machine, see *Chapter 11* of this User's Guide .
- 3 The default password for Brother Print/Fax servers is `access`.
- 4 The default domain name of the Print/Fax server is `WORKGROUP`, to change it use your web browser or the BRAdmin Professional utility.

## Print Server Configuration

---

In order for this function to work, you must correctly change the DOMAIN name or WORKGROUP name to match that of your network. Once this is done, the Print/Fax server will appear automatically in your network neighborhood and you will be able to send print documents to it without having to install additional software. However, in some instances you may find that your Windows® 95/98/Me/2000/XP and Windows NT® 4.0 systems may receive “Printer is busy” error messages when more than one person attempts to access the printer. In this instance Brother has provided the “Brother NetBIOS Port Monitor” software which allows users to continue spooling print jobs while the printer is busy, down or out of paper. The port monitor will hold the jobs until the printer is again available.

When you install Windows® 95/98/Me you are asked which workgroup you belong to. The default workgroup name for Windows® 95/98/Me is WORKGROUP, however you could change this to anything you want. With Windows NT® 4.0, Microsoft introduced the concept of “Domains”. A domain offers centralized security management whereas a workgroup offers distributed security management. The Print/Fax server does not care if your network consists of a Workgroup or a Domain, the only thing you must tell it is the name of the workgroup or domain. The Brother Print/Fax server automatically has a default workgroup/domain name of WORKGROUP. If you need to change name, you can configure the Brother print server to recognize this. There are three ways of doing this. (If you are unsure about the name of your workgroup or domain, look in the identification tab in your network applet).

- Use BRAdmin Professional utility (This utility can use the TCP/IP protocol or Netware IPX protocol - no file server necessary.)
- Use a Web browser (the Print/Fax server must have a valid IP address and your computer must also have a valid IP address); you can configure the IP address by using BRAdmin Professional utility.
- Use front panel on the machine. For more information, see *Chapter 10* of this User’s Guide.





Because of the way that Microsoft networks work, the Print/Fax server may take several minutes to appear in the network neighborhood. You will also find that the Print/Fax server may take several minutes to disappear from the network neighborhood even if the printer is switched off. This is a feature of Microsoft workgroup and domain based networks.

## Changing the workgroup/domain name using a web browser

---

You can change the workgroup/domain name using BRAdmin Professional utility. To do this press NetBIOS tab and then enter your workgroup/domain name into the **Domain Name** text box.

You can also use a standard WWW browser to change the NetBIOS name. To do this, connect to the print server using its IP address and then select the **Configure NetBIOS** option from the **Network Configuration** screen, then enter your workgroup/domain name into the **Domain Name** text box. Make sure you submit the changes (click on the **Submit** button).

# NetBIOS Port Monitor for Windows® 95/98/Me/2000/XP and Windows NT® 4.0

---

This software requires the TCP/IP transport protocols to be installed on your Windows® 95/98/Me/2000/XP and Windows NT® 4.0 computer. To install those protocols refer to your Windows® documentation.

If you are using the TCP/IP protocol, the proper IP address should be defined on both the Brother Print/Fax server and your client PC.

## Installing the Brother NetBIOS Port Monitor

---



If you already installed the driver from the printers CD-ROM Installer and you selected “Brother Peer to Peer Network Printer” during the installation then you do not need to install the Brother Network Print Software again.

- 1 Start the CD-ROM installation menu program according to the Quick Setup Guide.
- 2 Select the proper model and then the **Install Optional Applications** menu. Then select **Network Print Software** installation program.
- 3 Push the **Next** button in response to the Welcome message.
- 4 Select **Brother Peer to Peer Print (NetBIOS)** installation
- 5 Select the desired directory to install the **Brother Peer to Peer Print (NetBIOS)** files and push **Next**.
- 6 Enter the port name that you wish to use. The port name must start with “BNT”. For example BNT1. Whichever name you choose, it must be unique. Then press **OK**. The name must be unique on your PC, however other computers can use the same port name as the name you specify on your PC.

- 7 You must now enter the server name and port name for the actual Print/Fax server. You can use the **Browse** button to search for the Print/Fax server, select the domain/workgroup name, and then the server is listed. If the print server does not automatically appear in your browse list, then you must ensure that the domain name is configured correctly. Otherwise you must enter the name manually. The name should be compliant with UNC (Universal Name Convention). For example:

\\NodeName\ServiceName.

Where NodeName is the NetBIOS name of the Brother Print/Fax server (the default name is usually BRN\_XXXXXXX, where XXXXXX is the last six digits of the Ethernet address), and ServiceName is the service name for NetBIOS of the Print/Fax server. By default it is BINARY\_P1. For example:

\\BRN\_310107\BINARY\_P1



You can find the NetBIOS name and MAC address by printing out the printer configuration page. see *Resetting the Print/Fax Server back to factory settings (Test Switch)* on page 13-4 for information on how to print the configuration page on your Print/Fax server.

- 8 Then press **OK**.
- 9 Click the **Finish** button. You must now restart your computer before you can continue.

## Associating the Printer

---

- 1 You must now create a printer on your Windows® 95/98/Me/2000/XP and Windows NT® 4.0 systems using the standard Windows® printer setup procedure. To do this, go the **Start** button, select **Setting** and then **Printers**.

### Windows® 95/98/Me

- 2 Select **Add Printer** to begin the printer installation.
- 3 Click **Next** when you get the **Add Printer Wizard** window.

- 4 Select **Local Printer** when you are asked how the printer is connected to your computer, and then push **Next**.
- 5 Select the correct driver. Click **Next** when you are done.
- 6 If you have selected a printer driver that is already being used, you have the option of either keeping the existing driver (recommended) or replacing it. Select the desired option and press **Next**.
- 7 Select the **Brother NetBIOS Port** (the port name you assigned in step 6 of the “Installing the Brother NetBIOS Port Monitor” section and press **Next**.
- 8 Enter any desired name for the Brother machine and press **Next**. For example, you could call the printer “Networked Brother Printer”.
- 9 Windows® will now ask you if you wish to print out a test page, select **Yes** and then select **Finish**.

You are now ready to print. If necessary, you can share the printer on your PC so that all print jobs are routed through your computer.

## **Windows NT® 4.0 / Windows® 2000/XP**

- 2 Select **Add Printer** to begin the printer installation.
- 3 Click **Next** when you get the **Add Printer Wizard** window.
- 4 Select **Local printer** (Windows® 2000) or Local printer attached to this computer (Windows® XP) when you are asked how the printer is connected to your computer, and then push **Next**.
- 5 Select the **Brother NetBIOS Port** (the port name you assigned in step 7 of the “Installing the Brother NetBIOS Port Monitor” section and press **Next**.
- 6 Select the correct driver. Click **Next** when you are done.

- 7 If you have selected a printer driver that is already used, you have the option of either keeping the existing driver (recommended) or replacing it. Select the desired option and press **Next**.
- 8 Enter any desired name for the Brother printer and press **Next**. For example, you could call the printer “Networked Brother Printer”.
- 9 Select **Not Shared** or **Shared** and **Share Name** and press **Next**.
- 10 Windows® will now ask you if you wish to print out a test page, select **Yes** and then select **Finish**.

You are now ready to print. If necessary, you can share the printer on your PC so that all print jobs are routed through your computer.

## Adding a Second NetBIOS Print Port

---

- 1 You do not need to re-run the installation program to add a new NetBIOS port. Instead, press the **Start** button, select **Settings**, and open the **Printers** window. Click on the icon of the printer that you wish to configure, select **File** from the menu bar, and then choose **Properties**.

### Windows® 95/98/Me

- 2 Click on the **Details** tab and push the **Add Port** button. In the **Add Port** dialog, select the **Other** radio button and then highlight **Brother NetBIOS port**. Click **OK** and enter the port name. The default port name is BNT1. If you have already used this name, you will get an error message if you try to use it again, in which case use BNT2, etc... Once you have specified the port name, click the **OK** button. You will then see the **Port Properties Dialog**. Enter the Print/Fax server and port name of the printer that you wish to print to and click **OK**. You should now see the port that you have just created in the **Print to the following port** setting of the printer driver.

## Windows NT® 4.0 / Windows® 2000/XP

- 2 Click on the **Port/s** tab and push the **Add Port** button. In the **Add Port** dialog, highlight **Brother NetBIOS port**. Click **New Port** and enter the port name. The default port name is BNT1. If you have already used this name, you will get an error message if you try to use it again, in which case use BNT2, etc... Once you have specified the port name, click the **OK** button. You will then see the **Port Properties Dialog**. Enter the Print/Fax server and port name of the printer that you wish to print to and click **OK**. You should now see the port that you have just created in the **Print to the following port** setting of the printer driver.

## Other Sources of Information

---

- 1 Visit <http://solutions.brother.com/> for more information on network printing.
- 2 To learn how to configure the IP address on your machine, see *Chapter 11* of this User's Guide.

# 5 Configuring Internet Printing for Windows®

## Internet Printing Installation

---

### Overview

---

Brother's Brother Internet Print (BIP) software, for Windows® 95/98/Me and Windows NT® 4.0, allows a PC user at one location to send a print job to a Brother Printer at a remote location via the Internet. For example, a user on a PC in New York could print a document directly from his Microsoft Excel application program to a printer in Paris.

Windows® 2000/XP users can also use this BIP software, but are recommended to use the IPP protocol support that is part of the Windows® 2000/XP operating systems. Skip to the "Windows® 2000 IPP Printing" section of this document.

### Quick Tips:

- 1 The Automatic Private IP Addressing (APIPA) protocol automatically assigns an IP address from the range: 169.254.1.0 to 169.254.254.255. If you want to disable the APIPA protocol, set APIPA to Off using the machine control panel. For more information, see *APIPA* on page 10-9. If the APIPA protocol is disabled, the default IP address of a Brother Print/Fax server is 192.0.0.192. To change it, use the control panel, the BRAdmin Professional utility, Web BRAdmin software or let your DHCP server allocate an IP address to the machine.
- 2 To learn how to configure the IP address on your machine, see *Chapter 11* of this User's Guide.
- 3 The default password for Brother Print/Fax servers is `access`.
- 4 Windows® 2000/XP users can print using TCP/IP using the standard Network Printing software and IPP protocol software built into any Windows® 2000/XP installation.

- 5 Windows® 95/98/Me users can send print jobs using the IPP protocol via Windows® 2000 computer, provided that the Microsoft Internet Print Services software is installed on the client PC, Internet Information Server (IIS) is installed and running on the server and that the client PC is using version 4 or later of Microsoft Internet Explorer.

## Brother Internet Print General Information

---

The BIP software is installed using a standard Windows® 95/98/Me/2000/XP and Windows NT® 4.0 Installation Wizard. It creates a virtual port on the Windows® 95/98/Me/2000/XP and Windows NT® 4.0 PC that operates in a similar way to the standard LPT1 printer port from the application program point of view. The user can use the Windows® 95/98/Me/2000/XP and Windows NT® 4.0 Print Manager to create a printer that uses this port along with a standard Windows® 95/98/Me/2000/XP and Windows NT® 4.0-compatible printer. Any Windows® 95/98/Me/2000/XP and Windows NT® 4.0 applications program can therefore print to this printer (and hence to the virtual port) without modification or operational procedure.

When a job is printed to the BIP virtual port, it is actually MIME-encoded (converted to a standard Internet E-mail message) and sent out to a Brother Print/Fax server at the remote location. This means that BIP is compatible with most common E-mail software packages. The only requirement is that the E-mail server be capable of sending E-mail message over the Internet.

In more detail, the procedure works in the following way:

- If you are connected to a Local Area Network, the E-mail message is passed to the E-mail server, which in turn transmits the message out over the Internet using the SMTP protocol (Simple Mail Transport Protocol) to the remote Print/Fax server.
- If you are connecting via a modem directly to an Internet Service Provider (ISP), the ISP handles the routing of the E-mail to the remote Print/Fax server.



- At the remote site, an E-mail server receives the E-mail message. The remote Print/Fax server, which has its own E-mail address, uses the POP3 protocol (Post Office Protocol 3) to download the E-mail message from the E-mail server. It then decodes the attachment and prints it out on the printer.



If an E-mail is received that has not been configured to use the BIP virtual port driver, the printer will print the E-mail out as a text document.

## Brother Internet Print: Configuring the Brother Print/Fax Server

---

The Print/Fax server can be configured using BRAdmin Professional utility or by using a web browser.

### Print Server Configuration Checklist



Before configuring the print server to receive BIP jobs, be sure that the E-mail server at the remote site (the receiving end) is configured to handle the TCP/IP POP3, and SMTP protocols (SMTP is only required if the notification feature is enabled).

- 1 Configure the POP3 server on the E-mail server at the remote site with a mail account (Mailbox name) and password for the Brother Print/Fax server (generally, the mail account name will be the first part of the Email address; for example, if you assign the E-mail address emailprinter@xyz.com, then the mail account name would be emailprinter).
- 2 Make sure that the Print/Fax server is installed and running with TCP/IP enabled and has a valid IP address assigned to it.

Because access to the E-mail server on most networks is usually restricted, you may need to have your network administrator check the configuration and add the mail account.

# Brother Internet Print: Using BRAdmin Professional utility to Configure the Print Server

---



Skip this section if you wish to use the Web Browser to configure the Print/Fax server.

Using the BRAdmin Professional utility, you can configure the Brother print server using the TCP/IP protocol, or the IPX protocol.

The steps required to configure the Print/Fax server to receive print jobs from a Windows® 95/98/Me/2000/XP and Windows NT® 4.0 PC running the BIP software are as follows.

- 1 Start BRAdmin Professional utility.
- 2 Select the node name of the desired Brother Print/Fax server from the list and double click on it. (the default node name is usually `BRN_XXXXXX`, where `XXXXXX` is the last six digits of the Ethernet address (MAC address)). You will be prompted for a password; the default password is `access`.



You can find the node name and MAC address by printing out the machine configuration page. For information on how to print the configuration page on your Print/Fax server, see *Resetting the Print/Fax Server back to factory settings (Test Switch)* on page 13-4.

- 3 Click on the **POP3/SMTP** tab.
- 4 Enter the address of the POP3 server (consult your network administrator if you do not know this address).
- 5 Enter the mailbox name for the remote Brother Print/Fax server. Usually this will be the first part of the E-mail address (for example, if the E-mail address of the print server is `emailprinter@xyz`, then the mailbox name would be `emailprinter`).
- 6 Enter the password for the mailbox, if any.

- 7 The Print/Fax server is configured by default to poll the POP3 server every 10 minutes. You may change this value, if desired.
- 8 If you have enabled notification, enter the address of your SMTP server (consult your network administrator if you do not know this address).
- 9 Press the **OK** button and save the changes. Now exit the BRAdmin Professional utility. You have now configured the Print/Fax server to receive print jobs.

## **Brother Internet Print: Using a Web Browser to Configure the Print Server**

---

- 1 Connect to the printer server IP address using your web browser.
- 2 When you reach the network configuration screen, you will be prompted for a password. The default password is "access".
- 3 Select the **Configure POP3/SMTP** option and enter the information as described above. For more information, see *Brother Internet Print: Using BRAdmin Professional utility to Configure the Print Server* on page 5-4.
- 4 You should see a **Segmented Message Timeout** option. If a print job is separated into multiple E-mail messages using the Partial E-mail Print feature of the BIP, this value indicates how long the Print/Fax server will wait for all of the segments of the message to arrive.

# Brother Internet Print: Installing the BIP software on Windows® 95/98/Me/2000/XP and Windows NT® 4.0

---

To install the BIP software on a Windows® 95/98/2000/XP and Windows NT® 4.0 PC, execute the following steps:



- Be sure that the PC is running an E-mail program (for example, Microsoft Outlook) that is capable of sending E-mail message using Winsock.
- Be sure that your E-mail server is capable of sending messages across the Internet.

## Setup from CD-ROM

- 1 Start the CD-ROM installation menu program according to the Quick Setup Guide.
- 2 Select the proper model and **Install Optional Applications** menu. Then select **Network Print Software** installation program.
- 3 Push the **Next** button in response to the Welcome message.
- 4 Select the **Brother Internet Print** button.
- 5 Select the desired directory to install the BIP files and then push **Next**. The installation program will create the directory for you if it does not already exist.
- 6 You will then be asked for a port name. Enter the name of the port. The port name must begin with the BIP and end with a number, for example, BIP1.
- 7 You will then see a message about **Partial E-mail Print**. Partial E-mail Print is the ability of the Brother Internet Print software to break down E-mail Print jobs into smaller sections to prevent a mail file size limitation problem for the mail server.
- 8 Press **OK** to continue.

- 9 You will then be asked to enter the port settings for the remote Print/Fax server:

Enter any unique legal Internet E-mail address for the remote Print/Fax server (for example emailprinter@xyz.com). Note that Internet E-mail addresses cannot have spaces in them.

Enter your E-mail address and the IP address of your SMTP E-mail server (consult your network administrator if you do not know this address). Also specify if you are going to use the **Partial E-mail Print** option and the **Notification** type.

- 10 Press **OK** to continue. You will then be asked to re-start your computer.

- 11 Once your computer has re-started you must create a printer on your Windows® 95/98/Me/2000/XP and Windows NT® 4.0 system using the standard Windows® 95/98/Me/2000/XP and Windows NT® 4.0 printer setup procedure. To do this, go the **Start** button, select **Settings** and then **Printers** (Windows® 95/98/Me/2000/XP and Windows NT® 4.0). To do this, go to the **Control Panel**, select **Printers and Other Hardware** and then **Printers and Faxes** (or **Add a printer**)(Windows® XP)

- 12 Select **Add Printer** to begin the printer installation.

- 13 Click **Next** when you get the **Add Printer Wizard** window.

<For Windows® 95/98/Me users>

- 14 Select **Local Printer** when you are asked how the printers are connected to your computer and push **Next**.

<For Windows NT® 4.0 and Windows® 2000/XP users>

- 14 Select **Local Printer**, and then delete the check mark in **Plug and Play** check box.

<For Windows® XP users>

- 14 Select **Local Printer** attached to this computer.

### <For Windows® 95/98/Me users>

- 15 Select the desired model of the remote printer (for example, Brother HL-series). If necessary, click **Have Disk** to load the driver from the CD-ROM. Click **Next** when you are done.
- 16 If you have selected a printer driver that is already being used, you have the option of either keeping the existing driver (recommended) or replacing it. Select the desired option and press **Next**.
- 17 Select the **Brother Internet port** (BIP...) which you selected in step 6 and press **Next**.

### <For Windows NT® 4.0 and Windows® 2000/XP users>

- 15 Select the **Brother Internet port** (BIP...) which you selected in step 6 and press **Next**.
- 16 Select the desired model of the remote printer (for example, Brother HL-series). If necessary, click **Have Disk** to load the driver from the CD-ROM. Click **Next** when you are done.
- 17 If you have selected a printer driver that is already being used, you have the option of either keeping the existing driver (recommended) or replacing it. Select the desired option and press **Next**.
- 18 Enter any desired name for the BIP remote printer and press **Next**. Note that this name does not need to match the port name that you assigned in step 6, or E-mail address that you assigned in step 9.
- 19 Select **No** when asked if you want to print a test page, unless you have already configured the remote Print/Fax server to receive BIP print jobs.

You have now finished installing the BIP software. If you need to configure another remote Print/Fax server, go to the next section, "Adding a Second Brother Internet Port".

## Adding a Second Brother Internet Port

---

You should not re-run the install program to add a new Brother Internet Port. Instead, press the **Start** button, select **Settings**, and open the **Printers** window. Click on the icon of a printer that is using BIP, select **File** from the menu bar, and then choose **Properties**. Click on the **Details (Ports on Windows NT® 4.0)** tab and push the **Add Port** button.

In the **Add Port** dialog, select the **Other** radio button (Windows® 95/98/Me only) and then **Brother Internet Port**. Click **OK (New Port on Windows NT® 4.0)** and it will give you the **Port Name** text box. Any unique name can be given here as long as it starts with “BIP” and another port does not already exist with the same name.

## Windows® 2000/XP IPP Printing

---

Use the following instructions if you wish to use the IPP printing capabilities of Windows® 2000/XP.

- 1 Run the **Add Printer Wizard** and click the **Next** button when you see the **Welcome to the Add Printer Wizard** screen.
- 2 You are now able to select **Local Printer** or **Network Printer**.  
For Windows® 2000: Make sure that you select **Network Printer**.  
For Windows® XP: Make sure that you select **A Network Printer, or a Printer attached to another computer**.
- 3 You will see the **Add Printer Wizard** screen.
- 4 For Windows® 2000: Select **Connect to a printer on the Internet or on your intranet** and then enter the following in the URL field: `http://printer_ip_address:631/ipp` (Where `printer_ip_address` is the IP address or DNS name of your printer).

For Windows® XP: Select **Connect to a printer on the Internet or on a home or office network** and then enter the following in the URL field: `http://printer_ip_address:631/ipp` (Where `printer_ip_address` is the IP address or DNS name of your printer).

- 5 When you click **Next**, Windows® 2000/XP will make a connection with the URL that you specified.

### **IF THE PRINTER DRIVER HAS ALREADY BEEN INSTALLED**

If the appropriate printer driver is already installed on your PC, Windows® 2000/XP will automatically use that driver for use. In this case, you will simply be asked if you wish to make the driver the default driver, after which the Driver installation Wizard will complete. You are now ready to print.

### **IF THE PRINTER DRIVER HAS NOT BEEN INSTALLED**

One of the benefits of the IPP printing protocol is that it establishes the model name of the printer when you communicate with it. After successful communication you will see the model name of the printer automatically. This means that you do not need to inform Windows® 2000 the type of printer driver to be used.

- 6 Click **OK**. You will then see the printer selection screen in the **Add Printer Wizard**.
- 7 If your printer is not in the list of supported printers, click the **Have Disk** button. You will then be asked to insert the driver disk.
- 8 Click the **Browse** button and select the CD-ROM or network share that contains the appropriate Brother printer driver.
- 9 Now specify the model name of the printer.
- 10 If the printer driver that you are installing does not have a Digital Certificate you will see a warning message. Click **Yes** to continue with the installation. The **Add Printer Wizard** will then complete.
- 11 Click the **Finish** button and the printer is now configured and ready to print. To test the printer connection, print a test page.



## Specifying a Different URL

---

Please note that there are several possible entries that you can enter for the URL field.

### **http://printer\_ip\_address:631/ipp**

This is the default URL and we recommend that you use this URL. Please note the **Get More Info** option will not display any printer data.

### **http://printer\_ip\_address:631/ipp/port1**

This is for HP JetDirect compatibility. Please note the **Get More Info** option will not display any printer data.

### **http://printer\_ip\_address:631/**

If you forget the URL details, you can simply enter the above text and the printer will still receive and process data. Please note the **Get More Info** option will not display any printer data.

If you are using the built in service names that the Brother NC-9100h series Print/Fax server supports, you can also use the following: (However, please note the **Get More Info** option will not display any printer data).

```
http://printer_ip_address:631/brn_XXXXXX_p1  
http://printer_ip_address:631/binary_p1  
http://printer_ip_address:631/text_p1  
http://printer_ip_address:631/postscript_p1  
http://printer_ip_address:631/pcl_p1  
http://printer_ip_address:631/brn_XXXXXX_p1_at
```

Where `printer_ip_address` is the IP address of the printer.

## Other Sources of Information

---

- 1 Visit <http://solutions.brother.com/> for more information on network printing and for documents on the IPP protocol and how to configure a Windows® 2000/95/98/Me System.
- 2 Visit Microsoft's web site for the "Microsoft Internet Print Services" software for Windows® 95/98/Me.
- 3 To learn how to configure the IP address on your machine, see *Chapter 11* of this User's Guide.

# 6 Novell NetWare Printing

## How to Configure Novell NetWare Printing

---

### Overview

---

Brother Print/Fax servers allow NetWare client PCs to print jobs on the same printer as TCP/IP or other network protocol users. All NetWare jobs are spooled through the Novell server and delivered to the printer when it is available.

#### Quick Tips:

- 1 The Automatic Private IP Addressing (APIPA) protocol automatically assigns an IP address from the range: 169.254.1.0 to 169.254.254.255. If you want to disable the APIPA protocol, set APIPA to Off using the machine control panel. For more information, see *APIPA* on page 10-9. If the APIPA protocol is disabled, the default IP address of a Brother Print/Fax server is 192.0.0.192. To change it, use the control panel, the BRAdmin Professional utility, Web BRAdmin software or let your DHCP server allocate an IP address to the machine.
- 2 The default password for Brother Print/Fax servers is `access`.

## General Information

---

In order to use a Brother Print/Fax server on a NetWare network, one or more file servers must be configured with a print queue that the Print/Fax server can service. Users send their print requests to the file server's print queue, and the jobs are then spooled (either directly, or in the case of remote printer mode, via an intermediate Netware Print Server) to the appropriate Brother Print/Fax server.

The system administrator can create Bindery (NetWare 3), NDS (NetWare 3 and NetWare 4) based queues in a single environment without having to switch between applications by using the BRAdmin Professional utility.

NetWare 5 users wishing to configure an NDPS printer must use the NWADMIN application supplied with NetWare 5. Please note that it is possible to create IPX BINDERY or NDS based queues on a NetWare 5 system using the BRAdmin Professional utility.

You must install the Novell NetWare Client 32 if you wish to create queue information on your NetWare servers using the BRAdmin Professional utility.

If you can't use the BRAdmin Professional utility in your environment, you can create the queue using the traditional NetWare PCONSOLE utility or NWADMIN utilities, but you will then also need to use a WWW browser to configure the Print/Fax server.

Brother Print/Fax servers can service up to 16 file servers and 32 queues.

# Creating a NDPS Printer Using NWADMIN for NetWare5

---

With NetWare 5, Novell has released a new preferred printing system called Novell Distributed Print Services (NDPS). Before the Print/Fax server can be configured, NDPS must be installed on the NetWare 5 server and an NDPS Manager configured on the server.



For further information regarding NDPS printers and printing please see *Other Sources of Information* on page 6-13.

## NDPS Manager

---

This creates a NDPS manager that interacts with services running at the server and manages an unlimited number of printer agents.

You have to create an NDPS manager within an NDS tree before creating server-based printer agents. If the NDPS manager controls a printer attached directly to the server, you must load the manager on the server that the printer is attached to.

- 1 In NetWare administrator, navigate to the area you want the NDPS manager to reside. Select **Object | Create | NDPS Manager** and click **OK**.
- 2 Enter an **NDPS manager name**.
- 3 Browse to a server (which has NDPS installed but no NDPS manager installed) where you want to install the NDPS manager and then to the volume you want the NDPS manager database assigned to. Click **create**.

# NDPS Broker

---

When NDPS is installed, an NDPS broker is loaded onto the network. One of the Broker services Resource Management Service allows Printer Drivers to be installed onto the server for use with Printer Agents.

To add a Printer Driver to the Broker:

- 1 Make sure the **Resource Management Service** is enabled.
- 2 Open the **Broker Object's** main window in NetWare Administrator
- 3 Select the **Resource Management** view.
- 4 The **Resource Management** dialog appears. Select the **Add Resources** button.
- 5 When the **Manage Resources** dialog appears, select the icon for the type of driver you want to add. This will be a 3.1x, Windows® 95/98/Me or Windows NT® 4.0 driver for NetWare 5 (Additionally, a Windows® 2000 driver is available for NetWare 5.1). If you are using NDPS version 1 with NetWare 4.x, only 3.1x and 95/98/Me options will be available. NDPS version 2 for NetWare 4.x will support Windows NT® 4.0 drivers automatic download.
- 6 A complete list of currently loaded resources of that type appears in the **Current Resources** window. Click the **Add** button.
- 7 The **Add <resource type>** dialog appears. The listed resources that appear on this screen are currently installed.
- 8 Press the **Browse** button to locate the driver you want to add to the list. The driver list appears possibly showing several printers. This should be the driver in the different languages.

## Creating a Printer Agent

---

Follow the steps below to create a Printer Agent for the control access printer (NDS object).

- 1 In NetWare Administrator, select **object | create | NDPS Printer**. Enter the NDPS printer name.
- 2 If this is a new printer select **create A New Printer Agent**.
- 3 If there is already an NDS printer and you are upgrading it to use the NDPS scheme, select **Existing NDS printer object**. You will then have to select which printer object you wish to upgrade.
- 4 Enter the name you wish the Printer Agent to be referred to by, and either type the name of the NDPS Manager or click the reference button and select a NDPS Manager. Select **Novell Printer Gateway** for the **Gateway type** and click **OK**.
- 5 Select **None** for the printer Type, and **Novell Port Handler** for the Port Handler Type. Then click **OK**.
- 6 You must now specify the type of connection that you are going to use. There are four possible options. Select the **LPR over IP** option.
- 7 Enter the relevant details of the printer, and Brother recommends typing `Binary_P1` for the printer name. Click **finish** and wait. Select the printer drivers for the client operating systems.

Follow the steps below to create a Printer Agent for the public access printer.

- 1 In NetWare Administrator, double click **NDPS Manager**.
- 2 Click **Printer Agent List**.
- 3 Click **New**.
- 4 Enter the name you wish the Printer Agent to be referred to by, and select **Novell Printer Gateway** for the **Gateway type** and click **OK**.

- 5 Select **None** for the printer Type, and **Novell Port Handler** for the Port Handler Type. Then click **OK**.
- 6 You must now specify the type of connection that you are going to use. There are four possible options. Select the **LPR over IP** option.
- 7 Enter the relevant details of the printer and Brother recommends typing `Binary_P1` for the printer name. Click **finish** and wait. Select the printer drivers for the client operating systems.

You are now ready to print.

## Configuring NetWare 3 and NetWare 4 systems

---

Brother's BRAdmin Professional utility provides similar functionality to the NetWare PCONSOLE utility (or the NWADMIN utility in NetWare 4.1x or later). To use the BRAdmin Professional utility to create a Brother Print server under NetWare, make sure that you are logged in as SUPERVISOR (NetWare 2.xx or 3.xx) or ADMIN (NetWare 4.1x or later) and perform the appropriate steps as detailed in the following pages.



You must install the Novell NetWare Client 32 if you wish to create queue information on your NetWare servers by BRAdmin Professional utility.

## Creating a Network Print Server (Bindery Queue Server) using BRAdmin Professional utility

---

- 1 Make sure that you logged in as SUPERVISOR (NetWare 2.xx or 3.xx) or ADMIN (NetWare 4.xx or later).
- 2 Start BRAdmin Professional utility.

- 3 One or more Print/Fax servers will appear in the list (the default node names are BRN\_XXXXXX, where XXXXXX is the last six digits of the Ethernet address (MAC address)).



You can find the node name and MAC address by printing out the Network configuration page. For information on how to print the configuration page on your machine, see *Resetting the Print/Fax Sever back to factory settings (Test Switch)* on page 13-4.

- 4 Select the Print/Fax server that you wish to configure and double click it. You will be asked for a password. The default password is `access`.
- 5 Select the NetWare tab.



If necessary change the **Netware Print Server Name**. The default NetWare Print server name will usually be `BRN_XXXXXX_P1` where XXXXXX is the Ethernet address of the Print/Fax server. Be careful! Changing the name may impact the configuration of other protocols because the print server service names will be altered.

- a If it is not already selected, select **Queue Server** as the operating mode.
- b Click the **Change Bindery Queues** button.
- c Select the NetWare server which you wish to configure.
- d Select the **New Queue** button and type in the queue name which you wish to create.
- e Once you have done that highlight the queue name you created and click on the **Add** button.
- f Click on **Close** and then **OK**.

Now exit the BRAdmin Professional utility. You are ready to print.



# Creating a Network Print Server (NDS Queue Server) using BRAdmin Professional utility

---

- 1 Make sure that you logged in as `ADMIN` in NDS mode.
- 2 Start BRAdmin Professional utility.
- 3 One or more Print/Fax servers will appear in the list (the default node names are `BRN_XXXXXX`, where `XXXXXX` is the last six digits of the Ethernet address (MAC address)).



You can find the node name and MAC address by printing out the printer configuration page. For information on how to print the configuration page on your machine, see *Resetting the Print/Fax Server back to factory settings (Test Switch)* on page 13-4.

- 4 Select the printer that you wish to configure and double click it. You will be asked for a password. The default password is `access`.
- 5 Select the **NetWare** tab.
  - a If it is not already selected, select **Queue Server** as the operating mode.
  - b Select the correct NDS tree and NDS context (you can manually enter this information, or by clicking on the down arrow by the side of NDS tree and the **Change** button by the side of NDS Context, you can let BRAdmin Professional utility display your choices automatically). Once you have specified this information, click on the **Change NDS queues** button.
  - c In the **NetWare Print Queues** screen select the appropriate **TREE** and Context and then click the **New Queue** button.
  - d Enter the queue name and specify the volume name. If you do not know the volume name, select the **Browse** button to browse the NetWare volumes. When the information is entered correctly, select the **OK** button.

- e Your queue name will appear in the TREE and Context that you specified. Select the queue and click on **Add**. The queue name will then be transferred to the Service Print Queues Window. You will be able to see the TREE and Context information along with the queue name information in this Window.
- f Click on the **Close** button. Your Brother Print/Fax server will now log into the appropriate NetWare server.

Now exit the BRAdmin Professional utility. You are ready to print.

## Creating a Network Print Server (NDS Queue Server) using Novell NWADMIN and BRAdmin Professional utility

---

If you do not wish to use the Brother BRAdmin Professional utility application solely to configure your NetWare file server, use the following instructions for configuration using the NWADMIN application in conjunction with the BRAdmin Professional utility.

- 1 Make sure that you are logged in as `ADMIN` in NDS mode on the NetWare 4.1x (or later) file server and start the NWADMIN application.
- 2 Select desired **Context** that will contain the Printer and then click on **Object** from the menu bar and then **Create**. When you get the **New Object** menu, select **Printer** and then **OK**.
- 3 Enter the name of the printer and select **Create**.
- 4 Select the desired **Context** that will contain the default print queue, and then click on **Object** and **Create** to get the **New Object** menu.
- 5 Select **Print Queue** and then **OK**. Make sure that **Directory Service Queue** is selected and then type in a name for the default print queue.
- 6 Click on the button to select the print queue volume. Change the directory context if necessary, then select the desired volume (from **Available Objects**) and click **OK**. Click **Create** to create the print queue.

- 7 Change context if required and then double click the name of the printer you created in step 3.
- 8 Click **Assignments**.
- 9 Click **Add**.
- 10 Change the context if necessary.
- 11 Select the print queue you created in step 5.
- 12 Click **Configuration** and set the **Printer type** to **Other/Unknown**. Click **OK**.
- 13 Change the context if required, select **Object** from the menu bar and then **Create**. When you get the **New Object** menu, select **Print server** and then **OK**.
- 14 Enter the name of the Print server and select **Create**.



Enter the NetWare Print server name of the Print/Fax server exactly as it appeared in the NetWare tab of the BRAdmin Professional utility (this will generally be the BRN\_XXXXXX\_P1 default service name, unless you changed the name).

You can find the current service name and MAC address by printing out the machine configuration page. For information on how to print the configuration page on your machine, see *Resetting the Print/Fax Sever back to factory settings (Test Switch)* on page 13-4.

### **Important:**

Do not assign a password to the Print server or it will not log in.

- 15 Double click on the name of your Print server. Click on **Assignments** and then **Add...**
- 16 If necessary, change the directory context. Select the printer you created in step 3 and click **OK** and then **OK** again.
- 17 Exit NWADMIN.

- 18 Start the appropriate BRAdmin Professional utility, and select the correct Printer/Fax server from the list (by default, the node name is BRN\_XXXXXX, where XXXXXX is the last six digits of the Ethernet address (MAC address)).
- 19 Double click the appropriate Brother Print/Fax server. You will be prompted for a password, the default password is `access`. Now select the NetWare tab.
- 20 Select **Queue Server** as the operating mode.

The same service assigned by NetWare server name cannot be used for both queue server mode and remote printer mode.



- If you want to enable queue server capabilities on services other than the default NetWare services, you must define new services that are enabled for NetWare and for the desired port. See the *Appendix* in this manual for information on how to do this.
- 21 Enter the NDS tree name (note that a Print/Fax server can service both NDS and bindery queues).
  - 22 Type in the name of the context where the Print server resides.
  - 23 Exit the BRAdmin Professional utility making sure that you save the changes that you have made. You are now ready to print.

# Creating a Network Print Server (NDS Remote Printer) using Novell NWAdmin and BRAdmin Professional utility

---

To configure a Brother Print/Fax server for remote printer mode with NWADMIN (NetWare Administrator utility) and BRAdmin Professional utility, you will need to perform the following steps:

- 1 Make sure that the PSERVER NLM (NetWare Loadable Module) is loaded on your file server and that you are logged in as `ADMIN` in NDS mode on the NetWare 4.1x file server.
- 2 Start NWADMIN by double clicking on the icon. Select the desired **Context** that will contain the new printer.
- 3 Select **Object** from the menu bar and then **Create**. When you get the **New Object** menu, select **Printer** and then **OK**.
- 4 Enter the name of the printer and select **Create**.
- 5 Double click on the Print server name of your PSERVER NLM. Click on **Assignments** and then **Add**.
- 6 If necessary, change the directory context. Select the printer you created and click **OK**. Note the number of the printer, as you will use this later, then click **OK**.
- 7 Select the desired **Context** that will contain the default print queue, and then click on **Object** and **Create** to get **New Object** menu.
- 8 Select **Print Queue** and then **OK**. Make sure that Directory Service Queue is selected, and then type in a name for the default print queue.
- 9 Click on the button to select the print queue volume. Change the directory context if necessary, then select the desired volume (Objects) and click **OK**. Click **Create** to create the print queue.
- 10 Change context if required and then double click the name of the printer you created previously.
- 11 Click **Assignments** and then **Add**.

12 Change context if necessary and select the print queue you created. Click **OK** and then **OK** again, and then exit NWADMIN.

13 Start the appropriate BRAdmin Professional utility, and select the correct Print/Fax server you wish to configure (by default, the node name is BRN\_XXXXXX, where XXXXXX is the last six digits of the Ethernet address (MAC address))



You can find the Node name and MAC address by printing out the machine configuration page. For information on how to print the configuration page on your Print/Fax server, see *Resetting the Print/Fax Server back to factory settings (Test Switch)* on page 13-4.

14 Double click the appropriate Print server. You will be prompted for a password, the default password is `access`.

15 Now select the **NetWare** tab.

16 Select **Remote Printer** as the **Operating Mode**, select the name of your PSERVER NLM as the Print/Fax server Name and select the number of the printer from step 6 as the Printer Number.



The same service assigned by NetWare Print server cannot be used for both queue server mode and remote printer mode. If you want to enable remote printer capabilities on a service other than the default NetWare service, you must define new services that are enabled for NetWare and for the desired port.

17 Click **OK**. And exit BRAdmin Professional utility.

You must now unload the PSERVER NLM from your NetWare file server console and then reload it in order for the changes to take effect.

## Other Sources of Information

---

1 Visit <http://solutions.brother.com/> for more information on network printing.

2 To learn how to configure the IP address on your machine, see *Chapter 11* of this User's Guide.

# 7

# Printing from a Macintosh®

## Printing from a Macintosh® Using AppleTalk® and TCP/IP or Simple Network Configuration capabilities

---

This chapter explains how to configure the PostScript driver on a Network. For more information on how to configure the default Quick Draw driver on a Network, see the Quick Setup Guide included with the machine.

### Overview

---

Brother print servers support the AppleTalk protocol running over Ethernet (also known as EtherTalk). This allows Macintosh® users to print at the same time as all other Ethernet network using the AppleTalk (also referred to as EtherTalk) protocol.

With the release of System 8.6 or later, Apple introduced a TCP/IP printing capability. This allows Macintosh® users to send print jobs using the TCP/IP protocol.

With the release of OS/X 10.2, Apple® introduced support for Simple Network Configuration capabilities. Simple Network Configuration supports automatic network configuration. If you choose to use the Simple Network Configuration of your product, you usually do not need to configure any IP address settings yourself.

## Quick Tips:



- 1 The default name that will appear in the Chooser of a Macintosh® will usually be `BRN_XXXXXXX_P1_AT` (where `XXXXXXX` is the last 6 digits of the Ethernet address)
- 2 From a Macintosh® network, the easiest way to change this name is to assign an IP address to the printer and then use a Web browser to change the name. Connect to the machine using a web browser and then click on **Network Configuration**. Enter the password (the default password is `access`) then select **Configure AppleTalk**. Click on `BRN_XXXXXXX_P1_AT`, then on **Service Name**. Enter the new name that you wish to appear in **Chooser**. Then click on **Submit**.
- 3 Mac OS® 8.6 or later supports TCP/IP printing.
- 4 The default password for Brother print servers is `access`.
- 5 To print a printer settings page, see *Resetting the Print/Fax Sever back to factory settings (Test Switch)* on page 13-4.
- 6 The Automatic Private IP Addressing (APIPA) protocol automatically assigns an IP address from the range: 169.254.1.0 to 169.254.254.255. If you want to disable the APIPA protocol, set APIPA to Off using the machine control panel. For more information, see *APIPA* on page 10-9. If the APIPA protocol is disabled, the default IP address of a Brother Print/Fax server is 192.0.0.192. To change it, use the control panel, the BRAdmin Professional utility, Web BRAdmin software or let your DHCP server allocate an IP address to the machine.

## Macintosh® Configuration (Mac OS® 8.6 - 9.2)

---

Your Brother Printer is compatible with the standard Apple LaserWriter 8 printer driver (earlier versions of the LaserWriter drivers may crash or cause PostScript errors on large networks). If you do not have the LaserWriter 8 driver you must install it. Consult your Macintosh documentation for instructions on how to do this.



Before you try to use the Brother print server, you must first enable the EtherTalk protocol from the **Network Control Panel** on the Macintosh®. If the EtherTalk protocol is not selected, or the **Network Control Panel** does not exist, you must use Apple's **Network Installer** software to add these capabilities.

The appropriate PPD file supplied with your machine must first be installed. Insert the CD-ROM into the CD-ROM drive of your computer. Select the **Start Here OS 8.6-9.2** icon, select your language and follow the on-screen instructions for **Install Software**.

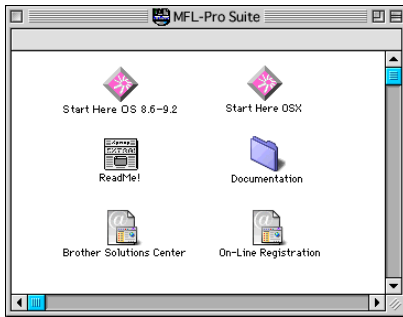

## How to Select the Print Server (AppleTalk/EtherTalk)

---

Once the Print/Fax server is connected on your network and the machine is powered on, the Brother print server's AppleTalk service name (default is `BRN_XXXXXX_P1_AT`, where `XXXXXX` is the last six digits of the Ethernet address (MAC address)) should appear in the **Chooser**.



You can find the service name and MAC address by printing out the configuration page. For information on how to print the configuration page on your print server, see *Resetting the Print/Fax Server back to factory settings (Test Switch)* on page 13-4.

- 1 Open the **Chooser** from the **Apple Menu** on the Macintosh®, and then click on the LaserWriter icon (if necessary, select the appropriate AppleTalk zone from the **Network Control Panel**).

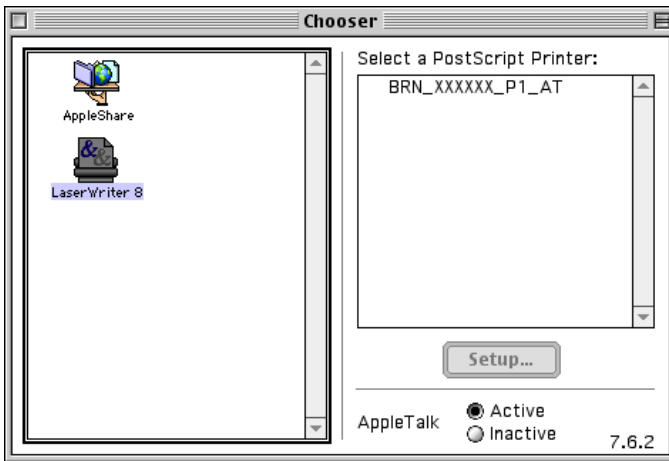

**Figure 2 Macintosh Chooser**

- 2 Click on the appropriate Print/Fax server and close the **Chooser** program. You should now be able to print from the Macintosh.



If you cannot see the Print/Fax server, first make sure that your cabling is correct and that you have enabled EtherTalk from your Macintosh **Network Control Panel**. You may also need to force the print server into the correct AppleTalk zone using the BRAdmin Professional utility or a web browser.

# How to Select the Print Server (TCP/IP)

Apple has developed the “**Desktop Printer**” utility. This can be found from the **Apple menu** (this is only available from System 8.6 or later). When you run it you will see the following screen:

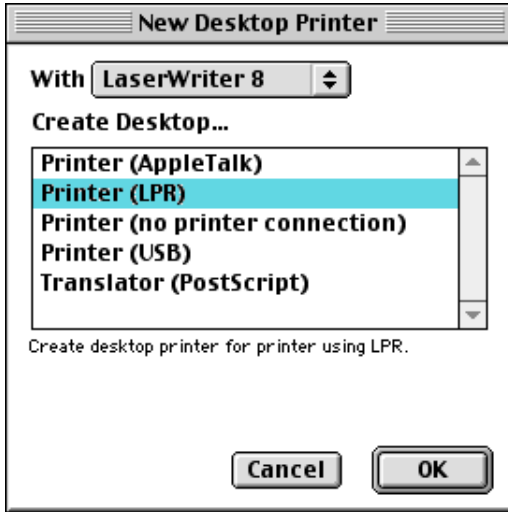

**Figure 3 Selecting LPR Printing**

- 1 Select the **Printer (LPR)** option and click **OK**. You will then see the following:

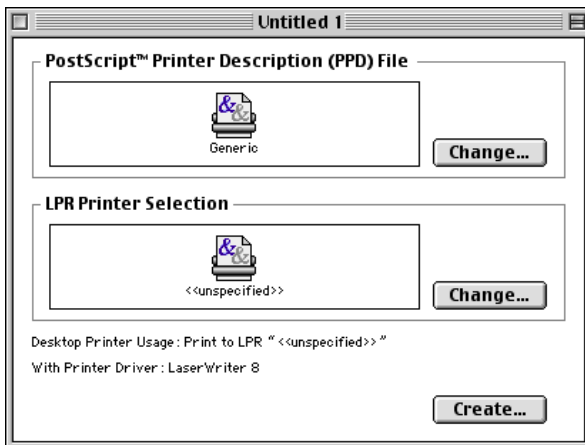

**Figure 4 Selecting the PPD and LPR Configuration**

- 2 At this point we must select the correct PPD file for the machine and also configure the correct LPR information. Click the **Change** button in the **PostScript Printer Description (PPD) File** section and select the appropriate PPD file for your model.
- 3 Now select the **Change** button below the **LPR Printer Selection** text.
- 4 You must then enter the IP address and service name details of the machine. When specifying the **Queue**, use the value `brn_XXXXXX_p1_at` where `XXXXXX` are the last 6 digits of the Ethernet address.

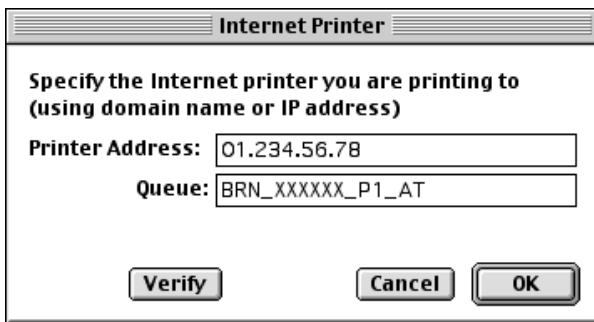

Internet Printer

Specify the Internet printer you are printing to  
(using domain name or IP address)

Printer Address: 01.234.56.78

Queue: BRN\_XXXXXX\_P1\_AT

Verify Cancel OK

**Figure 5 Entering the IP address and Queue**



If you do not specify the correct value the machine may not print, or it may not print the data correctly. Please ensure that the value you enter here matches with the Service name of the machine.

- 5 Click **OK** to go back to the previous screen.

- 6 You are now ready to create the printer for use. To do that, click the **Create** button and you will see the following:



**Figure 6 Saving the printer to the Desktop (screen shown is from the HL-7050)**

- 7 Enter the name of the printer in the **Save desktop printer As:** option and click on **Save**.
- 8 We must now make this our default printer by clicking the printer name once and then select **Printing** and **Set Default Printer**.

Whenever you send a print job, the printer that you just created will be used.

## Macintosh Configuration (Mac OS® X 10.1-10.2.1 or greater)

---

The appropriate PPD file supplied with your printer must be installed. Insert the CD-ROM into the CD-ROM drive of your computer. Select the **Start Here OSX** and follow the on-screen instructions.



## How to Select the Print Server (AppleTalk/EtherTalk)

---

After installing the PPD, use the following steps to select the printer driver:

- 1 Turn the power of the printer ON.
- 2 Open the **Applications** folder.
- 3 Open the **Utilities** folder.
- 4 Open the **Print Center** icon.
- 5 Click the **Add Printer** button.
- 6 Select **AppleTalk**.
- 7 Select `BRN_XXXXXX_P1_AT` and click the **Add** button.

For AppleTalk connections, the machine's AppleTalk service name is `BRN_XXXXXX_P1_AT`, where `XXXXXX` is the last six digits of the Ethernet address.

Printing the configuration page will allow you to confirm the MAC address. For information on how to print the configuration page, see *Resetting the Print/Fax Server back to factory settings (Test Switch)* on page 13-4.

- 8 From the **Printer Model** pull-down list select your model.
- 9 Click **Add** and the printer will be available from the **Printer List**.

## How to Select the Print Server (TCP/IP)

---

After installing the PPD, use the following steps to select the printer driver:

- 1 Turn the power of the printer ON.
- 2 Open the **Applications** folder.
- 3 Open the **Utilities** folder.
- 4 Open the **Print Center** icon.
- 5 Click the **Add Printer** button.
- 6 Select **LPR Printers using IP**.
- 7 Enter the TCP/IP address of the printer into the **LPR Printer's Address** box.

Printing the configuration page will allow you to confirm the TCP/IP address. For information on how to print the configuration page, see *Resetting the Print/Fax Server back to factory settings (Test Switch)* on page 13-4.

- 8 If you are not using the default **Queue** enter the Queue name you are using.
- 9 From the **Printer Model** pull-down list select your model.
- 10 Click **Add** and the printer will be available from the **Printer List**.

## Changing the Configuration

---

From a Macintosh, the easiest way to change the machine or Print/Fax server parameters is to use a web browser.

Simply connect to the machine using the format:

`http://ip_address` where `ip_address` is the address of the machine.

## Other Sources of Information

---

- 1 To learn how to configure the IP address on your machine, see *chapter 11* of this User's Guide.
- 2 For more information on web-based management, see *chapter 9* of this User's Guide.

## Printing from a Macintosh® using Simple Network Configuration capabilities of Mac OS® X

---

Simple Network Configuration lets you create an instant network of computers and smart devices just by connecting them to each other.

The Simple Network Configuration capabilities on a Macintosh® running OS X allows the Print/Fax server to automatically configure its IP address settings.

Please note that Brother recommends that you use Mac OS® X 10.2.4 or later version.



1 Run the **Print Center** software and click the **Add**.

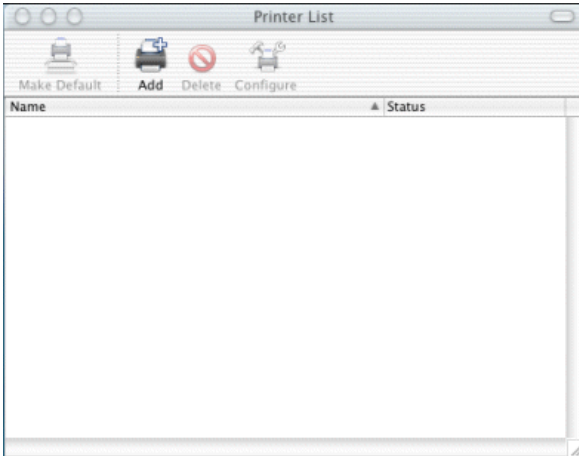

2 Select Rendezvous (may be changed in the future version of the Mac OS® X.) and any Simple Network Configuration compatible machines will be displayed.

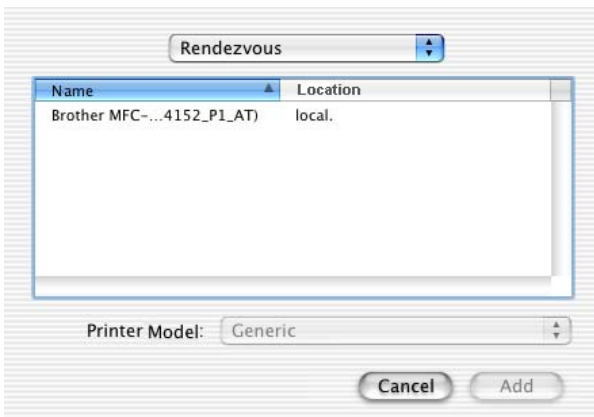

If you are using Mac OS® X 10.2.1, three machine are listed. Select any one of the machine listed.

3 Click the machine and then change the **Printer Model** to "Brother". The PPD files that are installed on your Macintosh are

displayed. Select the relevant PPD file.

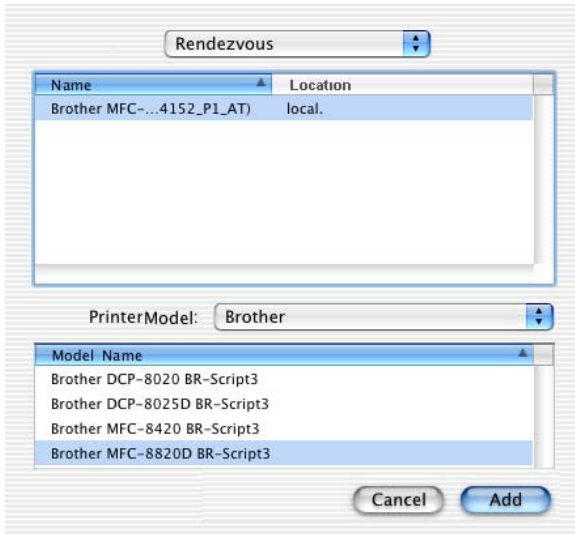

- 4 The Simple Network Configuration compatible machine is displayed.
- 5 Click the machine and click the **Make Default** button to set the printer as the default printer. The machine is now ready to print.

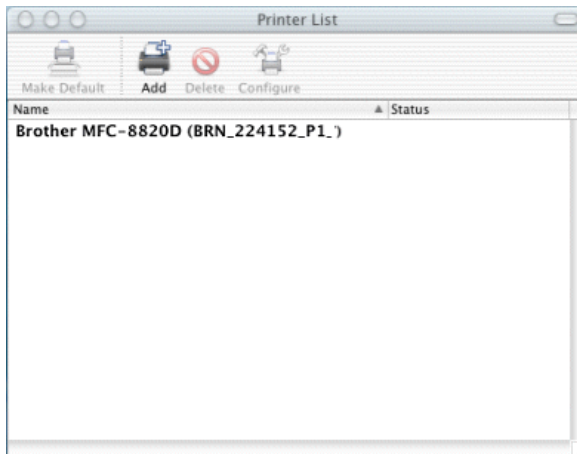

# 8 DLC Printing

## Printing from Windows NT<sup>®</sup> 4.0 or Windows<sup>®</sup> 2000

---

### Overview

---

DLC is a simple protocol that is included in Windows NT<sup>®</sup> 4.0 and Windows<sup>®</sup> 2000 as standard. It can be used on other operating systems (such as Windows<sup>®</sup> 3.x) with the addition of vendor-supplied software that supports the Hewlett-Packard JetDirect card.

### Quick Tips:

- 1 One way to print the details of all network settings is to print a configuration page. For information on how to print the configuration page, see *Resetting the Print/Fax Server back to factory settings (Test Switch)* on page 13-4.



Because DLC is a non-routable protocol, there cannot be a router between the print server and the sending computer.

## Configuring DLC on Windows NT<sup>®</sup> 4.0 and Windows<sup>®</sup> 2000

---

To use DLC on Windows NT<sup>®</sup> 4.0 and Windows<sup>®</sup> 2000, you must first install the DLC protocol.

- 1 Log into Windows NT<sup>®</sup> 4.0 with administrative privileges. Go to the Windows NT<sup>®</sup> 4.0 **Control Panel** and double click on the **Network** icon. Windows<sup>®</sup> 2000 users select the **properties** of the **Local Area Connection**.
- 2 On Windows NT<sup>®</sup> 4.0 systems, click on the **Protocol** tab, and click **Add**. Windows<sup>®</sup> 2000 users click the **Install** button from the **General** tab.

- 3 Select **DLC Protocol** and then **OK** or **Add** if using Windows® 2000. You may be asked for the location of the files. For Intel based computers, the necessary files are stored in the i386 directory of the Windows NT® 4.0 CD-ROM. If you have a non-Intel platform, specify the correct directory on your Windows NT® 4.0 CD-ROM and close the windows.
- 4 Reboot your system to make the change take effect. Windows® 2000 should not require a re-boot.

## Windows® 2000 Printer Setup

---

- 1 Log into Windows® 2000 with administrative privileges. From the **Start** menu, select **Settings** and then **Printers**.
- 2 Select **Add Printer** (If you have already installed a Brother printer driver, double click the printer driver that you wish to configure and then select **Printers/Properties**, select the **Ports** tab, click on **Add Port** and continue from Step 6 (ignoring steps 11-14 about installing the correct driver)).
- 3 Click **Next**.
- 4 Select **Local Printer** and make sure that **Automatically detect and install my Plug and Play printer** is not checked.
- 5 Click **Next**.
- 6 Select the **Create a new port:** option and highlight **Hewlett-Packard Network Port**.
- 7 Click **Next**.
- 8 A list of available Print/Fax server MAC addresses (Ethernet addresses) appears in the larger box under **Card Address**. Select the address of the desired Print/Fax server (you can see the Ethernet address on the configuration page).



You can find the node name and MAC address by printing out the configuration page. For information on how to print the configuration page on your Print/Fax server, see *Resetting the Print/Fax Sever back to factory settings (Test Switch)* on page 13-4.

- 9 The selected print server address will then appear in the smaller box under **Card Address**.
- 10 Type in any desired name for the port (the name must not be the name of an existing port or DOS device, such as LPT1) and click **OK** then on the **Printer Ports** screen, click **Next**.
- 11 Select the correct driver click **Next**.
- 12 Give a name to the printer and specify if you wish to be able to print from DOS application. Then click **Next**.
- 13 Specify the share name (if you are going to share the printer).
- 14 Enter the **Location** and **Comment** information and click **Next** until you see the **Completing the Add Printer Wizard** screen.
- 15 Click **Finish**.

## Windows NT<sup>®</sup> 4.0 Printer Setup

---

Log into Windows NT<sup>®</sup> 4.0 with administrative privileges. From the **Start** menu, select **Settings** and then **Printers**.

- 1 Select **Add Printer** (If you have already installed a Brother printer driver, double click the printer driver that you wish to configure and then select **Printers/Properties**, select the **Ports** tab and continue from Step 4 (ignoring steps 9-11 about installing the correct driver)).
- 2 Select **My Computer** and then click **Next**.
- 3 Select **Add a Port**.
- 4 Select **Hewlett-Packard Network Port** and then click **New Port**.

- 5 A list of available Print/Fax server MAC addresses (Ethernet addresses) appears in the larger box under **Card Address**. Select the address of the desired Print/Fax server (you can see the Ethernet address on the printer configuration page).



You can find the node name and MAC address by printing out the printer configuration page. For information on how to print the configuration page on your print server, see *Resetting the Print/Fax Server back to factory settings (Test Switch)* on page 13-4.

- 6 The selected Print/Fax server address will then appear in the smaller box under **Card Address**.
- 7 Type in any desired name for the port (the name must not be the name of an existing port or DOS device, such as LPT1) and click **OK** then on the **Printer Ports** screen, click **Close**.
- 8 The name you selected in the above step will appear as a checked port in the list of available ports. Click **Next**.
- 9 Select the correct driver. Click **Next**.
- 10 Give a name to the printer. If desired, select the printer as the default.
- 11 Select **Shared** or **Not Shared**. If shared, specify the share name and the operating systems that will be printing to it.
- 12 Select whether or not you want to print a test page, and then select **Finish**.

## Configuring DLC on Other Systems

---

To use DLC on other network systems, you will generally need vendor-supplied software. Typically such software will support the Brother Print/Fax servers. Follow the vendor's instructions to install the DLC protocol on your system.

Once the protocol is installed, create a network port in the same way that you did for Windows NT<sup>®</sup> 4.0 in the previous sections. The MAC address (Ethernet address) of the Print/Fax server should automatically appear during the configuration process.

The final step is to create a printer using the normal operating system printer setup method. The only difference is that instead of connecting the printer to the LPT1 parallel port, you point it to the network port you just created.



Brother does not recommend using the DLC protocol with Windows® for Workgroups 3.11 in a peer-to-peer configuration if the printer will be heavily used. This is because jobs may be rejected due to print spooler timeouts. The best solution in these situations is to set up one PC as a server for handling network print jobs. All of the other PCs send their print jobs to the server PC using NetBEUI or TCP/IP, and the server PC then uses DLC to send the print jobs to the Brother print server.

## **Other Sources of Information**

---

Visit <http://solutions.brother.com/> for more information on network printing.

# 9 Web Based Management

## How to use a Web Browser to manage your Device

---

### Overview

---

A standard Web Browser (we recommend Netscape Navigator version 4.0 or later/Microsoft Internet Explorer version 5.0 or later) can be used to manage your machine using the HTTP (Hyper Text Transfer Protocol). You can get the following information from a printer on your network using a web browser:

- 1 Printer status information.
- 2 Change Fax configuration items, such as Initial Setup. One Touch Dial settings and Remote Fax.
- 3 You can also change network settings such as TCP/IP information, Internet Fax address information, etc.
- 4 Software version information of the machine and print server.
- 5 Change network and machine configuration details.

You must use the TCP/IP protocol on your network and have a valid IP address programmed into the Print/Fax server and your computer.

### Quick Tips:

- 1 The Automatic Private IP Addressing (APIPA) protocol automatically assigns an IP address from the range: 169.254.1.0 to 169.254.254.255. If you want to disable the APIPA protocol, set APIPA to Off using the machine control panel. For more information, see *APIPA* on page 10-9. If the APIPA protocol is disabled, the default IP address of a Brother Print/Fax server is 192.0.0.192. To change it, use the control panel, the BRAdmin Professional utility, Web BRAdmin software or let your DHCP server allocate an IP address to the machine.



- 2 To learn how to configure the IP address on your machine, see *Chapter 11* of this User's Guide.
- 3 The default password for Brother print servers is `access`.
- 4 You can use a web browser on most computing platforms, for example, Macintosh and Unix users are also able to connect to the machine and manage it.
- 5 You can also use the BRAdmin Professional utility to manage the printer and its network configuration.

## How to connect to your machine using a Browser

---

Type `http://printer's IP Address /` into your browser (you can also use the NetBIOS name of the Print/Fax server, if you are in a Microsoft Windows domain/Workgroup environment). Enter the DNS name of the machine if connecting to a network that uses the DNS protocol.

## Password Information

---

Web Based Management offers two levels of password access. Users are able to access to the General Setup, Fax settings, I-Fax Settings and Lists and Reports. The default user name for Users is **user** (case sensitive) and the default password is **access**.

Administrators are able to access all settings. The login name for the Administrator is **admin** (case sensitive) and the default password is **access**.

## Other Sources of Information

---

- 1 Visit <http://solutions.brother.com/> for more information on network printing.
- 2 To learn how to configure the IP address on your machine, see *Chapter 11* of this User's Guide.

# 10 Front Panel Setup Menu

## LAN Main Setup Menu

---

With the Network (LAN) Board (NC-9100h Print/Fax Server) installed, you can connect your machine into the network to use the Internet FAX, Network Scanner and Network Printer.

- 1 Install the Network (LAN) Board (NC-9100h). For more information, see *Optional accessories* of User's Guide included with the machine.
- 2 Set up the machine for your Network using the control panel.

The LAN menu selections allow you to setup the Brother DCP/MFC for your network and Internet Fax configuration. Press **Menu** then press the appropriate number for LAN, based on the selections displayed on your machine. After you have displayed the LAN Main Setup menu, there are seven main selections: **Setup TCP/IP**, **Setup Internet**, **Setup Mail RX**, **Setup Mail TX**, **Setup Relay**, **Setup Misc** and **Scan to E-mail**. Proceed to the menu selection you wish to configure.



Please note that once you have specified a valid IP address for the machine, it is also possible to configure many aspects of the DCP/MFC using your favorite web browser. For added flexibility, the DCP/MFC is supplied with the BRAdmin Professional Windows® software, which also can be used to configure many aspects of the NC-9100h.

# Setup TCP/IP

---

This menu has nine sections: **Boot Method**, **IP Address**, **Subnet Mask**, **Gateway**, **Host Name**, **WINS Config**, **WINS Server**, **DNS Server** and **APIPA**.

## BOOT Method

- 1 (For MFC) Press **Menu**, **6**, **1**, **1**.  
(For DCP) Press **Menu**, **4**, **1**, **1**.
- 2 Press  or  to select **Auto**, **Static**, **RARP**, **BOOTP** or **DHCP**.
- 3 Press **Set**.
- 4 Press **Stop/Exit**.

## Static mode

In this mode the DCP/MFC IP address must be manually assigned. Once entered the IP address is locked to the assigned address.

## Auto mode

In this mode, the machine will scan the network for a DHCP server, if it can find one, and if the DHCP server is configured to allocate an IP address to the machine, then the IP address supplied by the DHCP server will be used. If no DHCP server is available, then the machine will scan for a BOOTP server. If a BOOTP server is available, and it is configured correctly, the machine will take its IP address from the BOOTP server. After it is initially powered ON, it may take a few minutes for the machine to scan the network for a server.



The machine supports “POWER SAVE mode” and you are using the AUTO Boot mode, POWER SAVE must be set to OFF.

## RARP mode

Brother Print / Fax server IP address can be configured using the Reverse ARP (RARP) facility on your host computer. This is done by editing the `/etc/ethers` file (if this file does not exist, you can create it) with an entry similar to the following:

```
00:80:77:31:01:07    BRN_310107
```

Where the first entry is the Ethernet address of the Print / Fax server and the second entry is the name of the Print / Fax server (the name must be the same as the one you put in the `/etc/hosts` file).

If the `rarp` daemon is not already running, start it (depending on the system the command can be `rarpd`, `rarpd -a`, `in.rarpd -a` or something else; type `man rarpd` or refer to your system documentation for additional information). To verify that the `rarp` daemon is running on a Berkeley UNIX-based system, type the following command:

```
ps -ax | grep -v grep | grep rarpd
```

For AT&T UNIX-based systems, type:

```
ps -ef | grep -v grep | grep rarpd
```

The Brother Print / Fax server will get the IP address from the `rarp` daemon when it is powered on.

## BOOTP mode

BOOTP is an alternative to `rarp` that has the advantage of allowing configuration of the subnet mask and gateway. In order to use BOOTP to configure the IP address make sure that BOOTP is installed and running on your host computer (it should appear in the `/etc/services` file on your host as a real service; type `man bootpd` or refer to your system documentation for information). BOOTP is usually started up via the `/etc/inetd.conf` file, so you may need to enable it by removing the “#” in front of the `bootp` entry in that file. For example, a typical `bootp` entry in the `/etc/inetd.conf` file would be:

```
#bootp dgram udp wait /usr/etc/bootpd bootpd -i
```



Depending on the system, this entry might be called “bootps” instead of “bootp”.

In order to enable BOOTP, simply use an editor to delete the “#” (if there is no “#”, then BOOTP is already enabled). Then edit the BOOTP configuration file (usually /etc/bootptab) and enter the name, network type (1 for Ethernet), Ethernet address and the IP address, subnet mask and gateway of the Print / Fax server. Unfortunately, the exact format for doing this is not standardized, so you will need to refer to your system documentation to determine how to enter this information (many UNIX systems also have template examples in the bootptab file that you can use for reference). Some examples of typical /etc/bootptab entries include:

```
BRN_310107 1 00:80:77:31:01:07 192.189.207.3
```

and:

```
BRN_310107:ht=ethernet:ha=008077310107:\  
ip=192.189.207.3:
```

Certain BOOTP host software implementations will not respond to BOOTP requests if you have not included a download filename in the configuration file; if this is the case, simply create a null file on the host and specify the name of this file and its path in the configuration file.

As with rarp, the Print / Fax server will load its IP address from the BOOTP server when the machine is powered on.

### **DHCP mode**

Dynamic Host Configuration Protocol (DHCP) is one of several automated mechanisms for IP address allocation. If you have DHCP Server in your network (typically a Unix, Windows® 2000/XP, Windows NT® 4.0 or Novell Netware network) the Print / Fax server will automatically obtain its IP address from DHCP server and register its name with any RFC 1001 and 1002-compliant dynamic name services.



If you do not want your Print / Fax server configured via DHCP, BOOTP or RARP, you must set the BOOT METHOD to static, this will prevent the Print / Fax server from trying to obtain an IP address from any of these systems. To change the BOOT METHOD, use the front panel, Web browser or by using the BRAdmin application.

## IP Address

This field displays the current IP address of the DCP/MFC. If you have selected a BOOT Method of STATIC, enter the IP address that you wish to assign to the DCP/MFC (check with your network manager for the IP address to use). If you have selected a method other than STATIC, the DCP/MFC will attempt to determine its IP address using the DHCP or BOOTP protocols. The default IP address of the Brother network board in your DCP/MFC will probably be incompatible with the IP address numbering scheme of your network. We recommend that you contact your network manager for an IP address for the network the unit will be connected on.

- 1 (For MFC) Press **Menu, 6, 1, 2.**  
(For DCP) Press **Menu, 4, 1, 2.**
- 2 Select **1** to change. Enter the IP address.
- 3 Press **Set.**
- 4 Press **Stop/Exit.**



When the BOOT METHOD is set to “AUTO”, the DCP/MFC cannot receive IP address from a BOOTP server in Windows® 2000. So please ensure that you use DHCP for Windows® 2000 server.

## Subnet Mask

This field displays the current subnet mask used by the DCP/MFC. If you are not using DHCP or BOOTP to obtain the subnet mask, enter the desired subnet mask. Check with your network manager for the subnet mask to use.

- 1 (For MFC) Press **Menu, 6, 1, 3.**  
(For DCP) Press **Menu, 4, 1, 3.**
- 2 Select **1** to change. Enter the Subnet Mask address.
- 3 Press **Set.**
- 4 Press **Stop/Exit.**

## Gateway

This field displays the current gateway or router address used by the DCP/MFC. If you are not using DHCP or BOOTP to obtain the gateway or router address, enter the address you wish to assign. If you do not have a gateway or router, leave this field blank. Check with your network manager if you are unsure.

- 1 (For MFC) Press **Menu, 6, 1, 4.**  
(For DCP) Press **Menu, 4, 1, 4.**
- 2 Select **1** to change. Enter the Gateway address.
- 3 Press **Set.**
- 4 Press **Stop/Exit.**



## Host Name

You can register the machine name on the Network. This name is often referred to as a NetBIOS name; it will be the name that is registered by the WINS server on your network. Brother recommends the name BRN\_XXXXXX (where XXXXXX is the last six digits of the Ethernet address) (up to 15 characters).

- 1 (For MFC) Press **Menu, 6, 1, 5.**  
(For DCP) Press **Menu, 4, 1, 5.**
- 2 Select **1** to change. Enter the Host Name.
- 3 Press **Set.**
- 4 Press **Stop/Exit.**

## WINS CONFIG

This selection controls how the DCP/MFC obtains the IP address for the WINS Server.

- 1 (For MFC) Press **Menu, 6, 1, 6.**  
(For DCP) Press **Menu, 4, 1, 6.**
- 2 Press  or  to select **Auto** or **Static**.
- 3 Press **Set**.
- 4 Press **Stop/Exit**.



### Auto

Automatically uses a DHCP request to determine the IP addresses for the primary and secondary WINS servers. You must set the BOOT Method to Auto for this feature to work.

### Static

Uses a specified IP address for the primary and secondary WINS servers.

## WINS Server

- 1 (For MFC) Press **Menu, 6, 1, 7.**  
(For DCP) Press **Menu, 4, 1, 7.**
- 2 Press  or  to select **Primary** or **secondary**.
- 3 Press **Set**.
- 4 Enter the WINS Server address.
- 5 Press **Set**.
- 6 Press **Stop/Exit**.

### Primary WINS Server IP Address



This field specifies the IP address of the primary WINS (Windows® Internet Naming Service) server. If set to a non-zero value, the machine will contact this server to register its name with the Windows® Internet Name Service.



### **Secondary WINS Server IP Address**

This field specifies the IP address of the secondary WINS server. It is used as a backup to the Primary WINS server address. If the Primary server is unavailable, the DCP/MFC still can register itself with a secondary server. If set to a non-zero value, the machine will contact this server to register its name with the Windows® Internet Name Service. If you have a primary WINS server, but no secondary WINS server, simply leave this field blank.

### **DNS Server**

- 1 (For MFC) Press **Menu, 6, 1, 8.**  
(For DCP) Press **Menu, 4, 1, 8.**
- 2 Press  or  to select **Primary** or **Secondary**.
- 3 Press **Set**.
- 4 Enter the DNS Server address.
- 5 Press **Set**.
- 6 Press **Stop/Exit**.

### **Primary DNS Server IP Address**



This field specifies the IP address of the primary DNS (Domain Name Service) server.

### **Secondary DNS Server IP Address**

This field specifies the IP address of the secondary DNS server. It is used as a backup to the Primary DNS server address. If the Primary server is unavailable, the DCP/MFC will contact the Secondary DNS server.

## APIPA

The setting of On will cause the print server to automatically allocate a Link-Local IP address in the range (169.254.1.0 - 169.254.254.255) when the print/fax server cannot obtain an IP address through the BOOT Method you have set (Menu, 6, 1). Selecting Off means the IP address doesn't change, when the print/fax server cannot obtain an IP address through the BOOT Method you have set

- 1 (For MFC) Press **Menu, 6, 1, 9.**  
(For DCP) Press **Menu, 4, 1, 9.**
- 2 Press  or  to select On or Off.
- 3 Press **Set.**
- 4 Press **Stop/Exit.**

## Setup Internet (For MFC only)

---

This menu has five selections: **Mail Address**, **SMTP Server**, **POP3 Server**, **Mailbox Name** and **Mailbox Pwd**. You may find that it is more convenient to use your favorite web browser to configure these settings.

### Mail Address

- 1 Press **Menu**, **6**, **2**, **1**.
- 2 Select **1** to change. Enter the mail address. Press **Set**.
- 3 Press **Stop/Exit**.

### Entering text

You can access the character you want by pressing the appropriate number key repeatedly.

Key	Once	Twice	Three times	Four times
1	@	.	/	1
2	A	B	C	2
3	D	E	F	3
4	G	H	I	4
5	J	K	L	5
6	M	N	O	6
7	P	Q	R	S
8	T	U	V	8
9	W	X	Y	Z

To change the mode between upper case and lower case for entering the E-mail / I-Fax address press **Shift** and **3**.

### Making corrections:

If you entered a letter incorrectly and want to change it, press  to move the cursor under the incorrect character. Then press **Clear/Back**. The letter above the cursor will be deleted. Re-enter the correct character.

### Repeating letters:

If you need to enter a character assigned to the same key as the previous character, press  move the cursor to the right.

As you enter the E-mail address, it will appear character by character on the LCD panel.

If you specify more than 16 characters, the LCD panel will scroll the name to the left, character by character. You can enter up to 60 characters.

Please note that also you can connect to the MFC using a web browser and specify the E-mail address information through Web Based Management.



### SMTP Server

This field displays the Host Name or IP address of an SMTP mail server (outgoing E-mail Server) on your network.

(Ex, mailhost.brothermail.net -or- 192.000.000.001)

- 1 Press **Menu, 6, 2, 2.**
- 2 Press  or  to select Name or IP Address.
- 3 Enter the SMTP SERVER Address.
- 4 Press **Set.**
- 5 Press **Stop/Exit.**

### POP3 Server

- 1 Press **Menu, 6, 2, 3.**
- 2 Press  or  to select Name or IP Address.
- 3 Enter the POP3 Server Address.
- 4 Press **Set.**
- 5 Press **Stop/Exit.**

### **POP3 Server address**

This field displays the Host Name or IP address of the POP3 server (incoming E-mail server) used by the Brother MFC. This address is necessary for the Internet Fax features to function correctly. (Ex, mailhost.brothermail.net -or- 192.000.000.001)

### **Mailbox Name**

- 1 Press **Menu, 6, 2, 4.**
- 2 Enter the user account name assigned to the Brother MFC to login to the POP3 Server.
- 3 Press **Set.**
- 4 Press **Stop/Exit.**

### **Mailbox Pwd**

- 1 Press **Menu, 6, 2, 5.**
- 2 Enter the user password assigned to the MFC to login to the POP3 Server. Please note that this password is case sensitive.
- 3 Press **Set.**
- 4 Press **Set** again to verify the password.
- 5 Press **Stop/Exit.**



## Setup Mail RX (For MFC only)

---

This menu has Five selections **Auto Polling**, **Poll Frequency**, **Header**, **Del Error Mail** and **Notification**.

### Auto Polling

When set to **On** the MFC automatically will check the POP3 server for new messages. "No Mail" will be displayed if there are no E-mail messages when the POP3 server is polled.

- 1 Press **Menu, 6, 3, 1.**
- 2 Press  or  to select **On** or **Off**.
- 3 Press **Set**.
- 4 Press **Stop/Exit**.



### Poll Frequency

Sets the interval for checking for new messages on the POP3 server (default is 10Min).

- 1 Press **Menu, 6, 3, 2.**
- 2 Enter the polling frequency.
- 3 Press **Set**.
- 4 Press **Stop/Exit**.

### Header

This selection allows the contents of the mail header to be printed when the received message is printed (**Subject+From+To** or **All** or **None**).

- 1 Press **Menu, 6, 3, 3.**
- 2 Press  or  to select **All** or **Subject+From+To** or **None**.

**3** Press **Set**.

**4** Press **Stop/Exit**.

## **Del Error Mail**

When set to **On**, the MFC automatically deletes error mails that the MFC can not receive from the POP server.

**1** Press **Menu, 6, 3, 4**.

**2** Press  or  to select **On** or **Off**.

**3** Press **Set**.



**4** Press **Stop/Exit**.

## **Notification**

Notification feature allows a receive notification message to be transmitted to the sending station to indicate successful reception of the I-Fax.

“**On**” send notification mail to all I-Fax machines only sends an E-mail to I-Fax that supports the “**MDN**” specification.

**1** Press **Menu, 6, 3, 5**.

**2** Press  or  to select **On** or **MDN** or **Off**.

**3** Press **Set**.

**4** Press **Stop/Exit**.

## Setup Mail TX (For MFC only)

---

This menu has three selections **Sender Subject**, **Size Limit** and **Notification**.



### Sender Subject

This field displays the subject that is attached to the Internet Fax data being sent from the Brother MFC to a PC (default is “Internet Fax Job”).

- 1 Press **Menu, 6, 4, 1**.
- 2 Select **1** to change the Sender Subject—**OR**—**2** to exit.
- 3 Enter the subject information.
- 4 Press **Set**.
- 5 Press **Stop/Exit**.

### Size Limit



Some E-mail servers do not allow you to send large E-mail documents. The MFC may display *Out of Memory* when trying to send E-mail documents (the System Administrator will often place a limit on the maximum E-mail size). With this function enabled, the MFC will display *Out of Memory* when trying to send E-mail documents over 1Mbyte in size. The document will not be sent and an error report will be printed. The document you are sending should be separated into smaller documents that will be accepted by the mail server. (Ex. A 42 page document of the ITU-T Test Chart#1 test chart is approximately 1Mbyte in size).

- 1 Press **Menu, 6, 4, 2**.
- 2 Press  or  to select *On* or *Off*.
- 3 Press **Set**.
- 4 Press **Stop/Exit**.



## Notification

Notification feature when switched to **On** sends two fields of data in addition to the image data which requests a notification from the receiving station for successful reception. The receiving I-Fax station must support the **MDN** standard in order to be able to understand the request and consequently submit a notification message confirming successful receipt of the I-Fax.

- 1 Press **Menu, 6, 4, 3**.
- 2 Press  or  to select **On** or **Off**.
- 3 Press **Set**.
- 4 Press **Stop/Exit**.



## Setup Relay (For MFC only)

---

This menu has three selections **RLY Broadcast**, **Relay Domain** and **Relay Report**. For more information on Relay Broadcast, see *Chapter 12* of this User's Guide.



### Rly Broadcast

This function allows the MFC to receive a document over the Internet, and then relay it to other fax machines through conventional analog landlines

- 1 Press **Menu, 6, 5, 1.**
- 2 Press  or  to select On or Off.
- 3 Press **Set.**
- 4 Press **Stop/Exit.**

### Relay Domain



You can register the Domain Names (Max.10) that are allowed to request a Relay Broadcast.

- 1 Press **Menu, 6, 5, 2.**
- 2 Press  or  to select the Relay Domain (01 - 10).
- 3 Press **Set.**
- 4 Enter the Relay Domain name for the Domain that is being allowed to request a Relay Broadcast.
- 5 Press **Set.**
- 6 Press **Stop/Exit.**

## Relay Report

Relay Broadcast Report can be printed at the MFC used as the Relay Station for all Relay Broadcasts. Also, when the MFC is used with the Brother Network PC Fax software the MFC is acting as a Relay Station for fax transmissions from the network so a Relay Report can also be printed for confirmation of sent network faxes. (For US / Canada only)

Its primary function is to print reports of Relay Broadcasts from external sources through the MFC. Please note that this is not possible without the consent of the Relaying Station as permission in the form of Relay Domain has to be given to external parties.



- 1 Press **Menu**, **6**, **5**, **3**.
- 2 Press  or  to select On or Off.
- 3 Press **Set**.
- 4 Press **Stop/Exit**.

## Setup Misc.



---

### Netware

You can select to switch the NetWare feature “On”, this allows you specify the Frame Type is item 2.

- 1 (For MFC) Press **Menu, 6, 6, 1.**  
(For DCP) Press **Menu, 4, 2, 1.**
- 2 Press  or  to select On or Off.
- 3 Press **Set.**
- 4 Press **Stop/Exit.**

### Net Frame

- 1 (For MFC) Press **Menu, 6, 6, 2.**  
(For DCP) Press **Menu, 4, 2, 2.**
- 2 Press  or  to select `Auto/8023/ENET/8022/SNAP.`
- 3 Press **Set.**
- 4 Press **Stop/Exit.**

Auto sets the Frame type to automatic, the network card will detect the frame type being used by the NetWare server (Recommended).

`8023` sets the Frame type to Ethernet 802.3

`ENET` sets the Frame Type to Ethernet II

`8022` sets the Frame type to Ethernet 802.2



`SNAP` sets the Frame type to Ethernet SNAP

\* NET Frame Setting is available when NetWare is On.



### AppleTalk

AppleTalk protocol is used with Macintosh Networks. If you are using your DCP/MFC on a Macintosh network please select to On.

- 1 (For MFC) Press **Menu, 6, 6, 3.**  
(For DCP) Press **Menu, 4, 2, 3.**



- 2 Press  or  to select On or Off.
- 3 Press **Set**.
- 4 Press **Stop/Exit**.

## DLC/LLC

- 1 (For MFC) Press **Menu, 6, 6, 4**.  
(For DCP) Press **Menu, 4, 2, 4**.
- 2 Press  or  to select On or Off.
- 3 Press **Set**.
- 4 Press **Stop/Exit**.

## Net BIOS/IP

The NC-9100h Print / Fax Server supports SMB (Server Message Block) over the TCP/IP protocol via the NetBIOS interface. This means that just like regular Windows® PC's the Brother DCP/MFC can appear in your network neighborhood. The main advantage of NetBIOS printing is that you are able to print from legacy DOS applications that are running on PC's that are connected to Microsoft networks.

- 1 (For MFC) Press **Menu, 6, 6, 5**.  
(For DCP) Press **Menu, 4, 2, 5**.
- 2 Press  or  to select On or Off.
- 3 Press **Set**.
- 4 Press **Stop/Exit**.



## Ethernet

Ethernet link mode. Auto allows the print server to operate in 100BaseTX full or half duplex, or in 10BaseT half duplex mode by auto negotiation.

100BaseTX Full Duplex (100B-FD) or Half Duplex (100B-HD) and 10BaseT Full Duplex (10B-FD) or Half Duplex (10B-HD) fix the print server link mode. This change is valid after the print server has been reset.





If you incorrectly set this value, you may not be able to communicate with your print server.

- 1 (For MFC) Press **Menu, 6, 6, 6.**  
(For DCP) Press **Menu, 4, 2, 6.**
- 2 Press  or  to select **Auto/100B-FD/100B-HD/10B-FD/10B-HD.**
- 3 Press **Set.**
- 4 Press **Stop/Exit.**

## Time Zone

This field displays the time zone you can set for your country. The time is the difference between your location and Greenwich Mean Time. This time will be shown on documents received via the Internet. For example the Time Zone for Eastern Time in the USA and Canada is GMT-05:00.

- 1 Press **Menu, 6, 6, 7.**
- 2 Press  or  to select the time.
- 3 Press **Set** to accept the selection.
- 4 Press **Stop/Exit** to exit the configuration menu.

## Windows® Time Zone Setting

You can determine the time difference for you location by using the Time Zone setting in Windows®.

- 1 Click on **Start.**
- 2 Select **Settings / Control Panel.**
- 3 Double click on **Date/Time.**
- 4 Select **Time Zone.**

Verify your time zone setting from the pull-down menu (this menu displays the time difference from GMT).

## User Setting List (For MFC only)

---

This feature prints a report listing all the current user settings. The NC-9100h Print / Fax Server Settings will be printed on the second page of the report.



- 1 Press **Menu**, **5**, **5**.
- 2 Press **Start**.
- 3 Press **Stop/Exit**.

## Setup Scan to E-mail (For MFC only)

---



### Color File Type for Scan to E-mail

You can select the default Color file type for Scan to E-mail (E-mail server) function.

- 1 Press **Menu**, **6**, **7**, **1**.
- 2 Press  or  to select **PDF** or **JPEG**.
- 3 Press **Set**.
- 4 Press **Stop/Exit**.

### Black and White File Type for Scan to E-mail

You can select the default Black and White file type for Scan to E-mail (E-mail server) function.

- 1 Press **Menu**, **6**, **7**, **2**.
- 2 Press  or  to select **PDF** or **TIFF**.
- 3 Press **Set**.
- 4 Press **Stop/Exit**.

# 11 TCP/IP Configuration

## Assigning TCP/IP Information

---

### Overview

---

The TCP/IP protocol requires that each device on the network have its own unique IP address. Use the following information to learn about IP address configuration.

The Automatic Private IP Addressing (APIPA) protocol automatically assigns an IP address from the range: 169.254.1.0 to 169.254.254.255. If the APIPA protocol is disabled, the default IP address of a Brother print server is 192.0.0.192. However, you can easily change this IP address number to match with the IP address details of your network. This can be done in any of the following ways:

- From your machine's control panel settings.
- BRAdmin Professional utility (for Windows<sup>®</sup> 95/98/Me/ 2000/XP and Windows NT<sup>®</sup> 4.0 using the IPX/SPX or TCP/IP protocols).
- DHCP, APIPA, Reverse ARP (rarp) or BOOTP.
- The ARP command.
- HTTP (Web browser).
- Other SNMP based management utility.
- Web BRAdmin software

These configuration methods are described in the following paragraphs.



The IP address you assign to the Print/Fax server must be on the same logical network as your host computers. If it is not, you must properly configure the subnet mask and the router (gateway).



## Using the machine control panel to allocate an IP address (Models with LCD panels only)

---

For details on how to configure IP address information using the machine control panel, see *chapter 10* of this User's Guide. By using the control panel on the machine, you can program the IP address details at the same time that other machine parameters are configured.

## Changing the IP Address using the BRAdmin Professional utility

---



Please use BRAdmin Professional utility version on the CD-ROM that was supplied with your Brother product or later. Please visit <http://solutions.brother.com> to download the latest Brother BRAdmin Professional utility version.

Start the BRAdmin Professional utility (from Windows® 95/98/Me/2000/XP and Windows NT® 4.0).

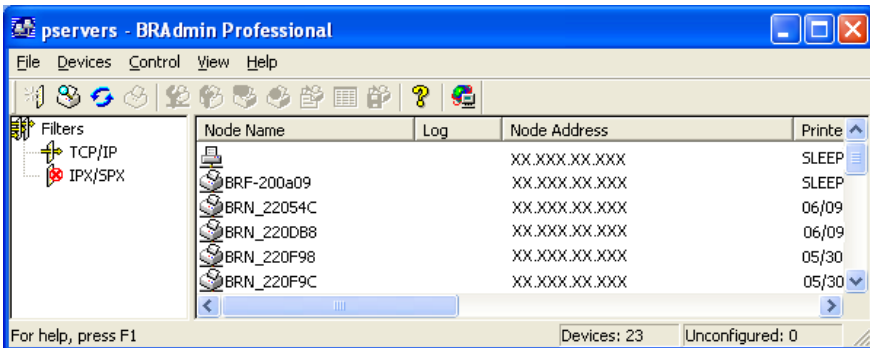

The BRAdmin Professional utility can use the IPX/SPX or TCP/IP protocols to communicate with the Brother Print/Fax server.

If you wish to use the TCP/IP protocol to manage the Print/Fax server make sure that the Print/Fax server has a valid IP address. If you are not using DHCP, BOOTP or RARP, you will want to change the IP address. There are two ways to change the IP address using the BRAdmin Professional utility:

- Use the IPX/SPX protocol.
- Use the TCP/IP protocol and let BRAdmin Professional utility find the Brother Print/Fax server as an unconfigured device.

## Using BRAdmin Professional utility and the IPX/SPX Protocol to set the IP address

---

If your PC is using the Novell Netware Client software and is using the IPX/SPX protocol, do the following:

- 1 Select **IPX/SPX filter** in the left frame of the main window.
- 2 Check the Print/Fax server name (the default node name is BRN\_XXXXXXX, where XXXXXX is the last six digits of the Ethernet address (MAC address)).

If you cannot find your server name, select the **Device** menu and choose **Search Active Devices** (you can also press the F4 key) and try again.



You can find the node name and MAC address by printing out the machine configuration page. For information on how to print the configuration page on your Print/Fax server, see *Resetting the Print/Fax Server back to factory settings (Test Switch)* on page 13-4.

- 3 Select the Print/Fax server that you wish to configure and double click it. You will be asked for a password. The default password is `access`.
- 4 Select the **TCP/IP** tab and set the **IP address**, **Subnet mask** and **Gateway** as needed.

- 5 In the **IP Config** box, click the **Static** radio button.
- 6 Click **OK**.

Restart the print server by using BRAdmin Professional utility or Web Browser. If you are not sure how to restart the print server, you may simply turn the machine's power switch off, and then switch it on.

## Using BRAdmin Professional utility and the TCP/IP Protocol to set the IP address

---

If your PC is using the TCP/IP protocol, do the following:

- 1 Select **TCP/IP filter** in the left frame of the main window.
- 2 Select the **Device** menu and choose the **Search Active Devices**.



If the MFC server is set to its factory default settings without using a DHCP server, the device will appear as APIPA in the BRAdmin Professional utility screen.

- 3 Select the **Devices** menu and choose **Setup Unconfigured Devices**.
- 4 Select the MAC address of your Print/Fax server and click the **Configure** button.

You can find the node name and MAC address by printing out the machine configuration page. For information on how to print the configuration page on your Print/Fax server, see *Resetting the Print/Fax Sever back to factory settings (Test Switch)* on page 13-4.

- 5 Enter the **IP address**, **Subnet mask** and **Gateway** (if needed) of your Print/Fax server.
- 6 Click **OK** then select **Close**.
- 7 With the correctly programmed IP address, you will see the Brother Print/Fax server in the device list.

## Using DHCP to Configure the IP address

---

The Dynamic Host Configuration Protocol (DHCP) is one of several automated mechanisms for IP address allocation. If you have DHCP Server in your network (typically a Unix/Linux, Windows NT<sup>®</sup> 4.0, Windows<sup>®</sup> 2000, XP or Novell Netware network) the Print/Fax server will automatically obtain its IP address from DHCP server and register its name with any RFC 1001 and 1002-compliant dynamic name services.



If you do not want your Print/Fax server configured via DHCP, BOOTP or RARP, you must set the BOOT METHOD to static so that the Print/Fax server has a static IP address. This will prevent the Print/Fax server from trying to obtain an IP address from any of these systems. To change the BOOT METHOD, use the machine's control panel, a Web browser or by using the BRAdmin Professional utility.

## Using APIPA to Configure the IP Address

---

With Automatic Private IP Addressing (APIPA), DHCP clients automatically configure an IP address and subnet mask when a DHCP server is not available. The device chooses its own IP address in the range 169.254.1.0 through to 169.254.254.255. The subnet mask is automatically set to 255.255.0.0 and the gateway address is set to 0.0.0.0.

By default, the APIPA protocol is enabled.

## Using ARP to Configure the Print/Fax Server IP Address

---

If you are unable to use the BRAdmin Professional utility or the FAX\MFC's control panel and your network does not use a DHCP server, you can also use the ARP command. The ARP command is available on Windows® systems that have TCP/IP installed as well as Unix systems. To use arp enter the following command at the command prompt:

```
arp -s ipaddress ethernetaddress
```

Where `ethernetaddress` is the Ethernet address (MAC address) of the Print/Fax server and `ipaddress` is the IP address of the Print/Fax server. For example:

### Windows® Systems

Windows® Systems require the hyphen “-” character between each digit of the Ethernet address.

```
arp -s 192.189.207.2 00-80-77-31-01-07
```

## Unix/Linux Systems

Typically, Unix systems require the colon “:” character between each digit of the Ethernet address.

```
arp -s 192.189.207.2 00:80:77:31:01:07
```



You must be on the same Ethernet segment (that is, there cannot be a router between the Print/Fax server and operating system) to use the `arp -s` command.

If there is a router, you may use BOOTP or other methods described in this chapter to enter the IP address.

If your Administrator has configured the system to deliver IP addresses using BOOTP, DHCP or RARP your Brother Print/Fax server can receive an IP address from any one of these IP address allocation systems. In which case, you will not need to use the ARP command. The ARP command only works once. For security reasons, once you have successfully configured the IP address of a Brother Print/Fax server using the ARP command, you cannot use the ARP command again to change the address. The Print/Fax server will ignore any attempts to do this. If you wish to change the IP address again, use a Web Browser, the machine's control panel or factory reset the Print/Fax server (which will then allow you to use the ARP command again).

To configure the Print/Fax server and to verify the connection, enter the following command `ping ipaddress` where `ipaddress` is the IP address of the Print/Fax server. For example, `ping 192.189.207.2`.

## Using RARP to Configure the IP Address

---

The Brother Print/Fax server's IP address can be configured using the Reverse ARP (rarp) facility on your host computer. This is done by editing the `/etc/ethers` file (if this file does not exist, you can create it) with an entry similar to the following:

```
00:80:77:31:01:07    BRN_310107
```

Where the first entry is the Ethernet address of the Print/Fax server and the second entry is the name of the Print/Fax server (the name must be the same as the one you put in the `/etc/hosts` file).

If the rarp daemon is not already running, start it (depending on the system the command can be `rarpd`, `rarpd -a`, `in.rarpd -a` or something else; type `man rarpd` or refer to your system documentation for additional information). To verify that the rarp daemon is running on a Berkeley UNIX-based system, type the following command:

```
ps -ax | grep -v grep | grep rarpd
```

For AT&T UNIX-based systems, type:

```
ps -ef | grep -v grep | grep rarpd
```

The Brother Print/Fax server will get the IP address from the rarp daemon when the printer is powered on.

## Using BOOTP to Configure the IP Address

---

BOOTP is an alternative to rarp that has the advantage of allowing configuration of the subnet mask and gateway. In order to use BOOTP to configure the IP address make sure that BOOTP is installed and running on your host computer (it should appear in the `/etc/services` file on your host as a real service; type `man bootpd` or refer to your system documentation for information). BOOTP is usually started up via the `/etc/inetd.conf` file, so you may need to enable it by removing the “#” in front of the bootp entry in that file. For example, a typical bootp entry in the `/etc/inetd.conf` file would be:

```
#bootp dgram udp wait /usr/etc/bootpd bootpd -i
```

Depending on the system, this entry might be called “bootps” instead of “bootp”.



In order to enable BOOTP, simply use an editor to delete the “#” (if there is no “#”, then BOOTP is already enabled). Then edit the BOOTP configuration file (usually `/etc/bootptab`) and enter the name, network type (1 for Ethernet), Ethernet address and the IP address, subnet mask and gateway of the Print/Fax server. Unfortunately, the exact format for doing this is not standardized, so you will need to refer to your system documentation to determine how to enter this information (many UNIX systems also have template examples in the `bootptab` file that you can use for reference). Some examples of typical `/etc/bootptab` entries include:

```
BRN_310107 1 00:80:77:31:01:07 192.189.207.3
```

and:

```
BRN_310107:ht=ethernet:ha=008077310107:\  
ip=192.189.207.3:
```



Certain BOOTP host software implementations will not respond to BOOTP requests if you have not included a download filename in the configuration file; if this is the case, simply create a null file on the host and specify the name of this file and its path in the configuration file.

As with rarp, the Print/Fax server will load its IP address from the BOOTP server when the machine is powered on.

# 12 Internet FAX (MFC Only)

## Overview

---

Internet Faxing (I-FAX) allows you to send and receive FAX documents using the Internet as the transport mechanism. Documents are transmitted in E-mail messages as attached TIFF-F files. This means that PC's are also able to receive and send documents, providing that the PC has as an application that can generate and view TIFF-F files, you can use Microsoft® Imaging or a TIFF-F viewer application [Pages Viewer] is available as a download from the Brother Web site <http://www.brother.com>. Any documents sent via the MFC will automatically be converted into a TIFF-F format. If you wish to send and receive messages to and from your MFC, your mail application on the PC must be able to support the MIME format.

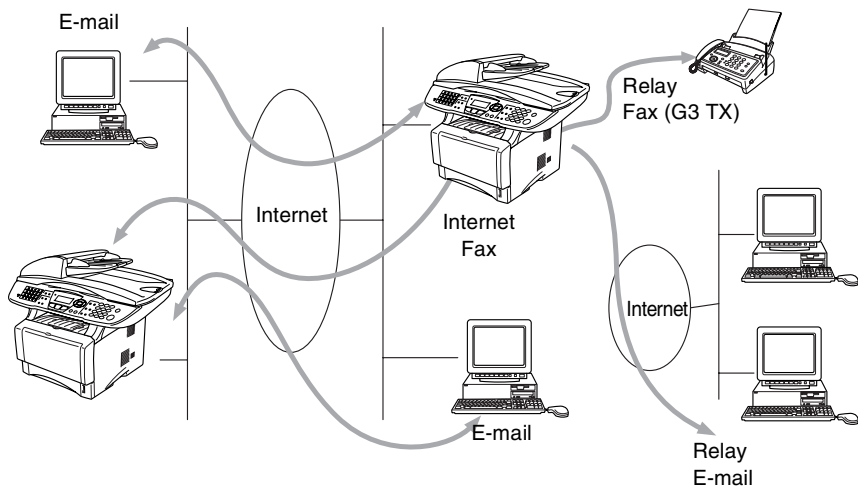

## Getting Connected

Before sending or receiving an Internet Fax you must configure your Brother MFC to communicate with your network and mail server. You must ensure the following: a correctly configured IP address for your MFC, an E-mail address for your MFC, the mail server(s) IP address, mailbox name and password for your Brother MFC. If you are unsure of any of these items, please contact your systems administrator. For details of how to configure this information, refer to the Web Based Management section (Internet Settings) of this User's Guide.

## Front Panel Key Functions

### Shift + 1

Used to change input mode. You can use Dial Pad keys as Standard alphabet character keys.

### Dial Pad

Used to enter Standard Alpha characters (28 letters), as well as @. space ! " # % & ' ( ) + / : ; < > = ? [ ] ^ - \$ , \* \_ € and Numbers.

### Shift + 3

To change between upper case and lower case for entering the e-mail / I-Fax address.



Moves the LCD cursor to the left or right when you enter the texts.

### Set

Used to store multiple numbers.

### Start

Begins transmitting the document.

### Stop/Exit

Deletes entered data and stops the scanning or transmitting process.

### One-touch / Speed-Dial / Group Dial

These functions work the same way as with conventional MFC's.

However, please note that you cannot use chain dialling for E-mail addresses.

### Shift + Start

Used to receive E-mail from the POP3 server manually.

## Sending an Internet Fax

---

Sending an Internet Fax is the same as sending a normal Fax. If you have already programmed the addresses of the Internet Fax receivers into the MFC as Speed-Dial locations, you can send the Internet Fax by loading the document into the MFC, use the Fax Resolution key to set the preferred resolution and select a Speed-Dial number and pressing Start.



This will differ depending on whether your MFC contains Speed-Dial keys or includes Navigator Keys.

If you wish to manually enter the Internet Fax Address load the document into the MFC and press **Shift** and **1** simultaneously to change into the “alphabet” dialling mode.

To manually enter the Internet Fax address, see *Manually Entering Text* on this page.



Internet Fax specification does not support color resolutions and files types.

## Manually Entering Text

---

Press **Shift** and **1** simultaneously to change into the “alphabet” dialling mode.

You can now use the Dial Pad to dial the E-mail address. Refer to the following table: Most number keys have three or four letters printed above them. The keys for 0, #, \* don't have printed letters because they are used for special characters.

By pressing the appropriate number key the correct number of times, you can access the character you want.

Key	Once	Twice	Three times	Four times
1	@	.	/	1
2	A	B	C	2
3	D	E	F	3
4	G	H	I	4
5	J	K	L	5
6	M	N	O	6
7	P	Q	R	S
8	T	U	V	8
9	W	X	Y	Z

If you want to enter a blank space, press  twice.

If you specify more than 16 characters, the LCD panel will scroll the name to the left character by character. You can enter up to 60 characters.

### Making corrections:

If you entered a letter incorrectly and want to change it, press  to move the cursor under the incorrect character. Then press **Clear/Back**. The letter above the cursor will be deleted. Re-enter the correct character.

### Repeating letters:

If you need to enter a character assigned to the same key as the previous character, press  to move the cursor to the right.

### Special characters and symbols

Press \* for (space) ! “ # \$ % & ’ ( ) \* + , - . / €

Press # for ; < = > ? @ [ ] ^ \_

Press Ø for É À È Ê Ë Ç Æ Ö Ø (For US and Canada users)  
 Ä Æ Ö Ü À Ç È E Ø (For other users)

As you enter the Internet Fax address, it will appear character by character on the LCD panel.

If you specify more than 16 characters, the LCD panel will scroll the name to the left character by character. You can enter up to 60 characters.

1 Press **Start** to send the document.

After the document is scanned, it is transmitted to the Recipient Internet Fax Machine automatically via your SMTP server. You can cancel the send operation by pressing the **Stop/Exit** button during scanning. After the transmission is finished, the machine will return to standby mode.

Some E-mail servers do not allow you to send large E-mail documents (the System Administrator will often place a limit on the maximum E-mail size). You can enable the Limit Size of the Sent Mail feature. The machine will display `Out of Memory` when trying to send E-mail documents over 1Mbyte in size. The document will not be sent and an error report will be printed. The document you are sending should be separated into smaller documents that will be accepted by the mail server. You can turn on this feature through the Web Management utility or the LAN function mode.

## Receiving E-mail or Internet Fax

---

There are 2 ways you can receive E-mail messages:

- POP3 receiving at regular intervals
- POP3 receiving (manually initiated)

Using POP3 receiving the MFC must poll the E-mail server to receive the print jobs. This polling can occur at set intervals (for example, you can configure the MFC to poll the E-mail server at 10 minute intervals) or you can manually poll the server by pressing the **Shift + Start** button.

If your MFC starts to receive E-mail print jobs, the LCD panel will reflect this activity. For example, you will see `Receiving` on the LCD panel followed by "xx MAIL(S)". If you press the **Shift + Start** buttons to manually poll the E-mail server for E-mail print jobs and there are no mail documents waiting to be printed, the MFC will display `No Mail` on the LCD panel for two seconds.

If your machine is out of paper when receiving data, the received data will be held in the MFC's memory. This data will be printed automatically after paper is re-inserted into the machine. (For European, Asian and Oceanian MFCs, Memory receive must be switched "ON".)

If the received mail is not in a plain text format or an attached file is not in the TIFF-F format, the following error message will be printed:

**ATTACHED FILE FORMAT NOT SUPPORTED. FILE**

**NAME:XXXXXX.doc** If the received mail is too large, the following error message will be printed: **E-MAIL FILE TOO LARGE**. If **Delete POP Receive Error Mail** is **ON** (default) then error mail is automatically deleted from the E-mail Server.

## **Receiving an Internet Fax to a PC**

---

**When a PC receives an Internet Fax document, the document is attached to a mail message that informs the PC that it is receiving a document from an Internet Fax. This is notified in the Subject field of the received mail message.**

If the PC to which you wish to send a document is not running Windows® 95/ 98/98SE/Me/2000/XP and Windows NT® 4.0 operating system, please inform the PC's owner that software must be downloaded for documents in the TIFF-F format to be viewed.

You can use "Microsoft® Imaging" that is supplied with Windows® 95/ 98/Me/2000/XP and Windows NT® 4.0 but some older versions of Windows® 95 do not support viewing TIFF-F documents.

## **Forwarding Received E-mail and Fax Messages**

---

You can forward received E-mail or standard fax messages to another E-mail address or fax machine. Received messages can be forwarded via E-mail to a PC or Internet Fax. They can also be forwarded via standard phone lines to another MFC.

Please see User's Guide included with the machine to check that this feature is supported. This function is not available for color fax documents.

This can be done using the Web Management Utility or through the front panel. The steps for configuring Fax Forward can be found in the User's Guide supplied with your MFC.

## Relay Broadcasting

---

This function allows the Brother MFC to receive a document over the Internet, and then relay it to other fax machines through conventional telephone lines.

If you wish to use your MFC as a relay broadcast device, you must specify the domain name that you trust at the MFC, in other words, the portion of the domain after the '@' sign.

A trusted domain refers to the E-mail address. For example, if the other party's address is bob@brother.com, then we identify the domain as brother.com. If the E-mail address is jack@brother.co.uk, then we identify the domain as brother.co.uk.

Use care in selecting a trusted domain since any user on a trusted domain will be able to send a Relay Broadcast. You can register up to 10 domain names.

Relay Broadcast can support the relay of a document up to a maximum of 48 fax machines through conventional telephone lines.

### Relay Broadcast from a MFC

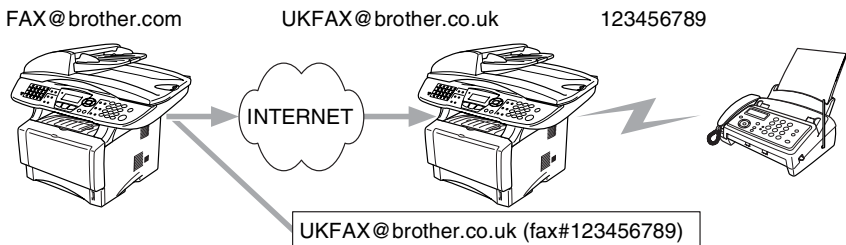



Your MFC has an E-mail address of FAX@brother.com, you wish to send a document from this machine to another MFC in England with an E-mail address of UKFAX@brother.co.uk, this machine will then forward the document to a standard fax machine using a conventional telephone line. If your E-mail address is FAX@brother.com, you must configure a trusted domain name of brother.com on the machine in England that will broadcast the document to the conventional fax machine. If you do not enter the domain name information, then the machine in the middle (the machine that will broadcast the document) will not trust any internet jobs that it receives from the MFC in the @brother.com domain.

After the trusted domain is set you can send the document from your MFC [I.E. FAX@brother.com] by entering the E-mail address of the MFC [I.E. UKFAX@brother.co.uk] that will forward the document followed by the phone number of the fax that will receive the document. The following is an example of how to enter the E-mail address and phone number.

UKFAX@brother.co.uk(fax#123456789)

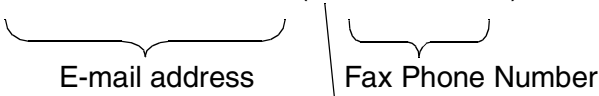

The word "fax#" must be included with the phone number inside the parenthesis.

**Sending to multiple phone numbers:**

If you want to have the document relayed to more than one standard fax machine the address can be entered using the following method:

- 1 Enter the phone number of the first Fax machine  
UKFAX@brother.co.uk(Fax#123).
- 2 Press the "Set" key.
- 3 Enter the phone number of the second Fax machine  
UKFAX@brother.co.uk(Fax#456).
- 4 Press **Start**.

## Relay Broadcast from a PC

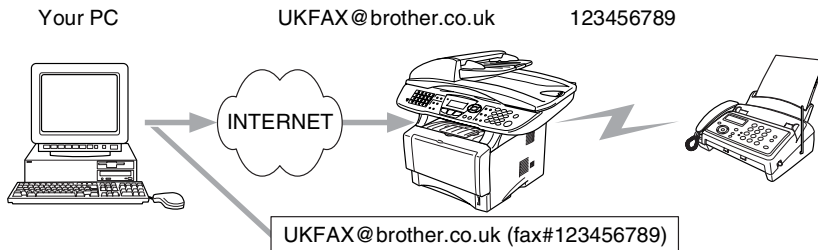

You can also send E-mail from your PC and have it relayed to a conventional FAX machine. The method of entering the phone number of the conventional FAX machine that will receive the relayed E-mail will vary depending on the mail application you are using. The following are some examples of different mail applications:

Some E-mail applications do not support sending to multiple phone numbers. If your E-mail application cannot support multiple phone numbers you will only be able to relay to one Fax machine at a time.

Enter the address of the relay MFC and phone number of the FAX in the "TO" box using the same method used when sending from an MFC.

UKFAX@brother.co.uk(fax#123456789)

### **Outlook 97/98/2000/XP:**

For Outlook 97/98/2000 and XP the address information must be entered into the address book as follows:

**Name:** fax#123456789

**E-mail Address:** UKFAX@brother.co.uk

## **TX Verification Mail**

---

Transmission Verification Mail supports two separate functions. Verification Mail for sending allows you request notification from the receiving station that the I-Fax or E-mail was received and processed. Verification Mail for receiving allows you to transmit a default report back to the sending station after successfully receiving and processing an I-Fax or E-mail.

To use this feature you must set the **Notification** option within the **Setup Mail RX** and **Setup Mail TX** options.

## Setup Mail (TX)

---

You can set the **Notification** option in the **Setup Mail TX** option to either ON or OFF. When switched to ON an additional field of information is sent with the image data. This field is named **MDN**.

### MDN

Mail Disposition Notification - This field requests the status of the I-Fax / E-mail message after delivery through the SMTP (send mail transfer protocol) transport system. Once the message has arrived at the Receiving station this data is used when the MFC or user reads or prints the received I-Fax or E-mail. For example, if the message is opened for reading or is printed the receiving station sends back a notification to the original sending machine or user.

The receiving station must support the MDN field in order to be able to send a notification report, otherwise the request will be ignored.

## Setup Mail (RX)

---

There are three possible settings for this option ON/MDN/OFF.

### Receive Notification “ON”

When switched to “ON” a fixed message is sent back to the sending station to indicate successful reception and processing of the message. These fixed messages depend on the operation requested by the sending station.

Report messages consist of

```
SUCCESS : Received From <mail address>
```

### Receive Notification “MDN”

When switched to “MDN” a report as described above is sent back to the sending station if the originating station sent the “MDN” field to request confirmation.

### Receive Notification “OFF”

OFF - Switches all forms of receive notification OFF, no messages are sent back to the sending station regardless of the request.

## **Error mail**

---

If there is a mail delivery error while sending an Internet Fax, the mail server will send an error message back to the MFC and the error message will be printed. If there is an error while receiving mail, an error message will be printed (Example: "The message being sent to the MFC was not in a TIFF-F format.").

## **Important information on Internet Fax**

---

Internet Fax Communication on a LAN system is basically the same as communication via E-mail; however, it is different from Fax communication using standard phone lines. The following is important information for using Internet Fax:

- Factors such as the receiver's location, structure of the LAN system, and how busy the circuit (such as the internet) is, may cause the system to take a long time to send back an error mail. (normally 20 sec. to 30 sec.).
- In the case of transmission through the Internet, due to its low level of security, we recommend that you use standard phone lines to send confidential documents.
- If the receiver's mail system is not compatible with the MIME format, you cannot transmit a document to the receiver. Depending on receiver's server, there may be some cases in which the error mail will not be sent back.
- If the size of a document's image data is huge, there is a possibility of unsuccessful transmission.
- You cannot change font and character size of Internet mail that you received.

# 13 Troubleshooting

## Overview

---

This chapter describes procedures for troubleshooting problems you may encounter with a Brother Print/Fax server, it is divided into the following sections:

- 1 Installation Problems
- 2 Intermittent Problems
- 3 Protocol-Specific Troubleshooting
- 4 Internet FAX Troubleshooting

## Installation problems

---

If you cannot print over the network, check the following:

- 1 Make sure that the machine is powered on, is on-line and ready to print.

Verify that the machine and the configuration are good by printing the machine configuration page. For more information, see *Resetting the Print/Fax Sever back to factory settings (Test Switch)* on page 13-4. If the test fails, check:

- a If the LED is not blinking after connected to the network, then the network firmware settings may be corrupted.
- b In this event, try to restore the factory default settings of the Print/Fax server. To learn how to reset the print server, see *Resetting the Print/Fax Sever back to factory settings (Test Switch)* on page 13-4. Once you have done that, switch the machine off and then on again, and try to print out the configuration page.

- 2 If the configuration page prints but you cannot print documents, try the following



If none of the following steps are successful, there is almost certainly a hardware or network problem!

**a If you are using TCP/IP:**

Try pinging the Print/Fax server from the host operating system command prompt with the command:

```
ping ipaddress
```

Where `ipaddress` is the Print/Fax server IP address (note that in some instances it can take up to two minutes for the Print/Fax server to load its IP address after setting the IP address). If a successful response is received, then proceed to the UNIX, TCP/IP Windows NT<sup>®</sup> 4.0/LAN Server, Windows<sup>®</sup>98/95/Me Peer to Peer (LPR), Internet Printing or Web Browser troubleshooting section. Otherwise, proceed to step 3, and then go to TCP/IP Troubleshooting section.

**b If you are using Novell system:**

Verify that the Print server can be seen on the network. To do this, login as the SUPERVISOR (not as someone with supervisor privileges) or ADMIN (for Netware 4 or later servers), go into PCONSOLE or NWADMIN, select PRINT SERVER INFORMATION, and select the name of the Print server (make sure that you have entered the Print server name). If you can see `Print Server Status and Control` in the menu, then the Brother Print/Fax server is visible to the network, proceed to the Novel NetWare Installation Troubleshooting Section. Otherwise, go to step 3.

**c If you are running AppleTalk for Macintosh:**

In case of using Postscript driver make sure that you can see the Print/Fax server name under the LaserWriter 8 icon in the Chooser. If it is visible, then the connection is good, so proceed to the AppleTalk for Macintosh Section. Otherwise, go to step 3.

- 3** If you cannot make any of the connections in step 2, check the following:
  - a** Make sure the machine is powered on and on-line.
  - b** Check the cabling, network connection, and print out a configuration page in the Network STATISTICS information to see if bytes are being transmitted and received.
  - c** Check to see if there is any LED activity.

The NC-9100h Print/Fax server has two LEDs on the back panel of the machine. The upper side LED shows Link/Speed status. The lower side LED shows Activity (Receive/Transmit) status.

■ **No light:**

If the both of two LEDs are off, then the Print/Fax server is not connected to the network.

■ **Link/Speed LED is orange: Fast Ethernet**

The Link/Speed LED will be orange if the Print/Fax server is connected to a 100BaseTX Fast Ethernet network.

■ **Link/Speed LED is green: 10BaseT Ethernet**

The Link/Speed LED will be green if the Print/Fax server is connected to a 10BaseT Ethernet network.

- 4** If you are using a repeater or hub, make sure that SQE (heartbeat) is turned off at the hub (if applicable). Also, if you have a hub or multi-port repeater, verify that the hub or repeater port is good by trying the Print/Fax server on a different port or on the other hub or multi-port repeater.
- 5** If you have a bridge or router located between the Print/Fax server and host computer, make sure that the device is set up to allow the Print/Fax server to send and receive data from the host. For example, a bridge can be set up to only allow certain types of Ethernet addresses to pass through (a process known as filtering); therefore, such a bridge must be configured to allow Brother Print/Fax server addresses. Likewise, a router can be set up to pass only certain protocols, so be sure that the desired protocol can be passed through to the Print/Fax server.

- 6 If the job exits the queue but does not print, make sure that you are not trying to print a text job to a PostScript printer. If you have a printer that is capable of automatic language switching, make sure that the printer is not forced into PostScript mode.

## Resetting the Print/Fax Server back to factory settings (Test Switch)

---

- Short push:  
Prints a network configuration page.
- Long push (more than 5 seconds):  
Resets the network configuration back to factory default setting.

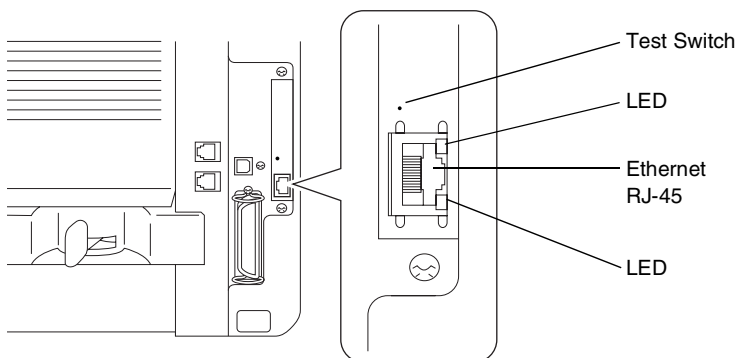

## Intermittent Problems

---

If the Print/Fax server and printer start up OK, but you intermittently have problems printing, check the following:

- 1 If you can print small jobs but large graphics jobs are distorted or incomplete, make sure that you have adequate memory in your printer and the latest printer driver installed on your computer. The latest Brother printer drivers can be downloaded from <http://solutions.brother.com>
- 2 Check the individual protocol troubleshooting sections in this chapter for additional causes of intermittent printer problems.



# TCP/IP Troubleshooting

---

If you are using TCP/IP and cannot print to the Print/Fax server and you have checked the hardware and network as described in the previous steps, then check the following:



It is always a good idea to try following in order to eliminate the possibility of setup errors.

Turning off the printer and then on again, Deleting and recreating the Print server and creating a new print queue in order to eliminate the possibility of setup errors.

- 1 The problem may be the result of mismatched or duplicate IP address. Verify that the IP address is correctly loaded into the Print/Fax server (via the configuration page. Make sure that no other nodes on the network have this address (DUPLICATE IP ADDRESS ARE THE BIGGEST CAUSE OF TCP/IP PRINTING PROBLEMS).
- 2 Make sure that the TCP/IP protocol of the Print/Fax server is enabled.
- 3 If you used rarp, make sure that you started the rarp daemon on any workstation using the rarpd, rarpd-a, or equivalent command. Verify that the `/etc/ethers` file contains the correct Ethernet address and that the Print/Fax server name matches the name in the `/etc/hosts` file.
- 4 If you used bootp, make sure that you started the bootp daemon on any UNIX workstation and bootp is enabled (i.e., the “#” is removed from the bootp entry) in the `/etc/bootptab` file is correctly configured.
- 5 Also verify that host computer and the Print/Fax server are either on the same subnet, otherwise that the router is properly configured to pass data between the two devices.

# UNIX Troubleshooting

---

- 1 Make sure that the `/etc/printcap` file (if applicable) is typed in correctly. In particular, look for missing “:” and “\” characters, because a small error anywhere in the file can have major consequences. Also check the `/usr/spool` directory to make sure that you have created a valid spool directory.

- 2 If you are using a Linux operating system, the X-Window Print tool program that is included with Linux may not properly configure the `etc/printcap` file for `lpd` operation, then you might also edit the `etc/printcap` file and change the following line in the entry for the printer.

```
if
:lp = /dev/null: \
```

```
then to
:lp = :\
```

- 3 If you are using a Berkeley-based UNIX, make sure that the daemon is started on Berkeley based systems with the command `lpc start printer`, where `printer` is the name of the local print queue.
- 4 If you are using an AT&T-based UNIX, make sure the printer is enabled (`enable printer`, where `printer` is the name of the local print queue).
- 5 Make sure that the `lpr/lpd` remote line printer service are running on the host computer (refer to your host computer documentation for information on how to do this).

- 6 If text or PCL jobs are run together, try setting the service (remote printer) with EOT set to string number 2 (<ESC>E). For example:

```
SET SERVICE BRN_XXXXXX_P1 EOT 2
```

- 7 If PostScript jobs fail to print or are run together, try setting the service (remote printer) with EOT set to string number 3 (control-D). For example:

```
SET SERVICE BRN_XXXXXX_P1 EOT 3
```

- 8 If the lines of a text file are staggered, make sure that you have specified a remote printer (`rp`) name of `TEXT` in your `/etc/printcap` file.

- 9 If you are using Sun Solaris V2.4 or earlier, there is a bug which causes long print jobs to fail when using a Printer/Fax server. If you are having trouble printing long jobs (over 1MB), add the line `mx#0` to your `etc/printcap` file entry.
- 10 If you cannot print from DEC TCP/IP Service for VMS (UCX), make sure that you have version 2.0B or later of this software, because earlier versions will not work with Brother Print/Fax servers.

## Windows NT® 4.0/LAN Server (TCP/IP) Troubleshooting

---

If you are having trouble printing with Windows NT® 4.0 or LAN Server, check the following:

- 1 Make sure that TCP/IP and TCP/IP print service are installed and running on the Windows NT® 4.0 system or the LAN Server file server.
- 2 If you are using DHCP and you have not created a reservation for the Print/Fax server, make sure that you enter the NetBIOS name of the Print/Fax server in the **Name or address of server providing lpd** box.

## Windows® 95/98/Me Peer to Peer Print (LPR) Troubleshooting

---

If you are having trouble printing on a Windows® 95/98/Me Peer-to-Peer network (LPR method), check the following:

- 1 Make sure that the Brother LPR Port driver is correctly installed and configured according to the Windows® 95/98/Me Peer-to-Peer chapters.
- 2 Try to turn the **Byte Count** on in the **Configure port** area of printer driver properties.

You may find that during the installation of BLP software, the screen that prompts you for a Port name is not displayed. This may happen on some Windows® 95/98/Me computers. Press the ALT and TAB keys to make it appear.

## **Windows® 95/98/Me Peer-to-Peer (HP JetAdmin compatible method) Troubleshooting**

---

If you are having trouble printing on a Windows® 95/98/Me Peer-to-Peer network, check the following (HP JetAdmin compatible method):

- 1 If the Print/Fax server does not show up under JetAdmin on a Windows® 95/98/Me Peer-to-Peer network, try removing all of the Windows® 95/98/Me network software from the Network Control panel and then reinstalling them as follows:
  - First install the IPX/SPX-Compatible Protocol (or the TCP/IP protocol if you are using a later version of JetAdmin), the Client for Microsoft Networks, and the network adapter card driver.
  - Install the Latest HP JetAdmin software.
  - Restart the system, and then add the HP JetAdmin service.

## **Windows® 95/98/Me/2000/XP and Windows NT® 4.0 Peer-to-Peer Print (NetBIOS) Troubleshooting**

---

If you are having trouble printing on a Windows® 95/98/Me/2000/XP and Windows NT® 4.0 (or later) Peer-to-Peer network (NetBIOS), check the following:

- 1 Make sure that the Brother NetBIOS Port driver is securely installed and configured according to the Windows® 95/98/Me/2000/XP and Windows NT® 4.0 Peer-to-Peer (NetBIOS) chapters. You may find that during the installation of the port driver, the screen that prompts you for a Port name is not displayed. This happens on some Windows® 95/98/Me/2000/XP and Windows NT® 4.0 computers. Press the ALT and TAB keys to make it appear.
- 2 Make sure that the Print/Fax server is configured to be in the same workgroup or domain as the rest of your computers. It may take several minutes for the Print/Fax server to appear in the network neighborhood.

## Brother Internet Print (TCP/IP) Troubleshooting

---

- 1 The first step in troubleshooting is to make sure that you have a valid E-mail connection on both the sending PC and the receiving Print/Fax server. Try sending an E-mail message from the PC to a user at the remote site who can receive mail via the POP3 server. If this does not work, there may be an E-mail configuration problem on the PC, on the local E-mail server, or on the remote POP3 server. Double check to make sure that the E-mail parameters that you configured on the PC and on the remote Print/Fax server match those that are configured on the E-mail servers.
- 2 If you can print small files OK but are having problems printing large files, the problem may be in the E-mail system. Some E-mail systems have difficulties printing large files. If the file does not reach its destination intact, then the problem is with the E-mail system.
- 3 You can also enable the partial E-mail print facility on your client PC, this will split the E-mail up into fragments which should then not overwhelm your E-mail server. To do this, select the property dialog of the Brother Internet Print Port.

## Windows® 95/98/Me/2000/XP IPP Troubleshooting

---

### **Want to use a different Port number other than 631**

If you are using Port 631 for IPP printing, you may find that your firewall may not let the print data through. If this is the case, use a different port number (port 80), or configure your Firewall to allow Port 631 data through.

To send a print job using IPP to a printer using Port 80 (the standard HTTP port) enter the following when configuring your Windows® 2000/XP system.

```
http://ip_address/ipp
```

**“Get More Info” option in Windows® 2000 not working**  
**“Go to Printer’s Web site” in Windows® XP not working**  
If you are using a URL of:

`http://ip_address:631` or `http://ip_address:631/ipp`, the **Get More Info** option in Windows® 2000 or the **Go to Printer’s Web site** option in Windows® XP will not function. If you wish to use the **Get More Info** or the **Go to Printer’s Web site** option use the following URL:

`http://ip_address`

This will then force Windows® 2000/XP to use Port 80 to communicate with the Brother Print/Fax server.

**Windows® 95/98/Me clients not able to get the driver from a Windows® 2000/XP system.**

You must be using version 4.0 or later of Internet Explorer and the **Microsoft Internet Print Services** software must be installed on your client computers.

## **Novell NetWare Troubleshooting**

---

If you cannot print from NetWare and you have checked the hardware and network as described in the previous steps, first verify that the Brother Print/Fax server is attached to the server queue by going to PCONSOLE, selecting PRINT QUEUE INFORMATION, and then CURRENTLY ATTACHED SERVERS. If the Print server does not appear in the list of attached servers, then check the following:



It is always a good idea to try followings in order to eliminate the possibility of setup errors.

- Turning off the machine and then on again to force to rescan the Netware queue.
- Deleting and recreating the Print server and creating a new print queue in order to eliminate the possibility of setup errors.

- 1 If you changed the login password, you must change the password in both the Brother Print/Fax server (using the `SET NETWARE PASSWORD` command if you are using the BRConfig software or by using a web browser or the BRAdmin Professional utility) and in the file server (using the `PCONSOLE Print Server Information Change Password` command).
- 2 If you created the print queue using `PCONSOLE` and BRConfig instead of BRAdmin Professional utility, make sure that you have enabled at least one NetWare file server using the `SET NETWARE SERVER servername ENABLED` command.
- 3 Have you exceeded your NetWare user limit?
- 4 Make sure that the Print server name you used in `PCONSOLE` exactly matches the name that is configured in the Print/Fax server, and make sure it is defined as a Queue Server for the print queue.
- 5 If you are running both 802.3 and Ethernet II frames on different file servers on your network, there is a possibility that the Print/Fax server may not make a connection to the desired file server. Try forcing the frame type to the desired one using the `SET NETWARE FRAME` command from the Print/Fax server remote console or using BRAdmin Professional utility.
- 6 If you are using `DOS CAPTURE` statement and losing portions of your print job, try setting the `TIMEOUT` parameter in your `CAPTURE` statement to a higher value (at least 50 seconds for Windows®).

## AppleTalk Troubleshooting

---

In case of using Postscript driver, if you cannot print from an AppleTalk for Macintosh computer and you have checked the hardware and network as described in the previous steps, then check the following:

- 1 Make sure that you are running Phase 2 AppleTalk and that you have selected the correct network interface from the AppleTalk Control Panel on the Macintosh.

- 2 Make sure that the AppleTalk protocol of the Print/Fax server is enabled.
- 3 If you have a large network, make sure that you have the Laser Writer V8.xx or equivalent driver, since earlier versions may cause PostScript errors. Also, verify that you get the correct printer information when you select Printer Info from the Setup button in the Chooser.
- 4 Make sure that you have selected the correct Printer Description File (PPD) from the Chooser (otherwise PostScript errors may result).
- 5 Verify that you have selected the correct AppleTalk zone. Because the Print/Fax server gets its zone information from router broadcasts, it may not be in the zone you expect, and will therefore not show up in the Chooser. If this is the case, you may need to force the zone name using BRAdmin Professional utility, a web browser.

## **DLC/LLC Troubleshooting**

---

If you are having trouble printing with DLC/LLC, check the following:

- 1 Make sure that the DLC/LLC protocol is enabled using either BRAdmin Professional utility, a web browser or TELNET.
- 2 Make sure that the MAC address of the Windows® setting is the same as shown in the **network configuration page** printout.

## **Web Browser Troubleshooting (TCP/IP)**

---

- 1 If you can not connect to the Print/Fax server using your web browser it may be worth checking the Proxy Settings of your browser. Look in the Exceptions setting and if necessary, type in the IP address of the Print/Fax server. This will stop your PC from trying to connect to your ISP or proxy server every time you wish to look at the Print/Fax server.
- 2 Make sure that you are using the proper Web Browser, we recommend Netscape Navigator version 4.0 or later/ Microsoft Internet Explorer version 4.0 or later.



## Internet Fax Troubleshooting

---

- 1 If there is a mail delivery error while sending an Internet Fax, the mail server will send an error message back to the machine and the error message will be printed. If there is an error while receiving mail, an error message is printed (Ex. **The message being sent to the machine was not in a TIFF-F format.**) All documents transmitted to the machine via E-mail must be in a TIFF-F format.
- 2 If an error message is printed while receiving E-mail text from a PC **ATTACHED FILE FORMAT NOT SUPPORTED** the senders mail application may not be set for a **Plain Text** format or **Vcard** the virtual business card feature may be set to **ON**.
- 3 If the receiver's mail system is not compatible with the MIME format, you cannot transmit a document to the receiver. Depending on the receiver's server, there are some cases that the error mail will not be sent back.
- 4 Messages cannot be received in an HTML format. This format is not supported. All messages must be received in a TIFF-F Format.
- 5 If the size of a documents image data is huge, there is a possibility of unsuccessful transmission if the system administrator has imposed a limit on the maximum size of E-mails and their attachments. The document you are sending should be separated into smaller documents that will be accepted by the mail server. (Ex. A 42 page document of the CCITT#1 test chart is approximately 1Mbyte in size).
- 6 If you do not receive E-mail, check the Auto Polling setting and Polling frequency.
- 7 If you cannot retrieve mail from the mail server, check the settings for the POP3 server and Mailbox name. Check that the POP3 password is entered correctly. This setting is case sensitive.
- 8 If Relay Broadcast is not forwarding E-mail to a G3 Fax, check the Relay Broadcast settings and Relay Domain registration. A Relay Domain must be entered for this function to work.

- 9 The Relay Broadcasting and Broadcasting features cannot be used at the same time.
- 10 Relay Broadcast can support the relay of a document up to a maximum of 48 Fax machines through conventional telephone lines. If sending to more than 48 locations the sender must divide the transmission locations into 48 locations or less for each relay broadcast.
- 11 When receiving E-mail messages from the POP3 server, the machine can receive a maximum of 32 mail messages. If there are more than 32 mail messages in the POP3 server, the machine will receive a maximum of 32 mail messages and then receive the remaining after the next polling interval.
- 12 The NC-9100h Print / Fax Server requires a portion of the user memory for operation. With the NC-9100h installed the number of Fax sheets that can be sent or received will be reduced (by approximately 30 pages of the brother No1 Test Chart) from the standard machine capacity.

# 14 Brother Internet Fax Printing Software

## Overview

---

Depending on your network configuration and application requirements for sending faxes via a network, you can choose between Brother Network PC FAX Software or Brother Internet Fax Printing Software. With either software, viewable document such as web pages, word documents, PDF documents can be sent from the users desktop to any standard Facsimile machines, Internet fax machines and E-mail addresses.

Brother Internet Fax Printing Software (BFP) is a Windows® 95/98/Me, Windows NT® 4.0 and Windows® 2000/XP software utility that gives network PC Fax and Internet Fax functionality from the desktop to users on your network or over the Internet.

BFP utilizes SMTP as the transport for sending documents from your PC. This allows any PC supported by a SMTP mail server to send an Internet FAX even if that PC does not have direct access to the networked machine.

Brother Network PC Fax Software utilizes LPR as the transport for sending documents from your PC to the networked machine for transmission. This requires that the sending PC has access to the network that the sending machine is connected.

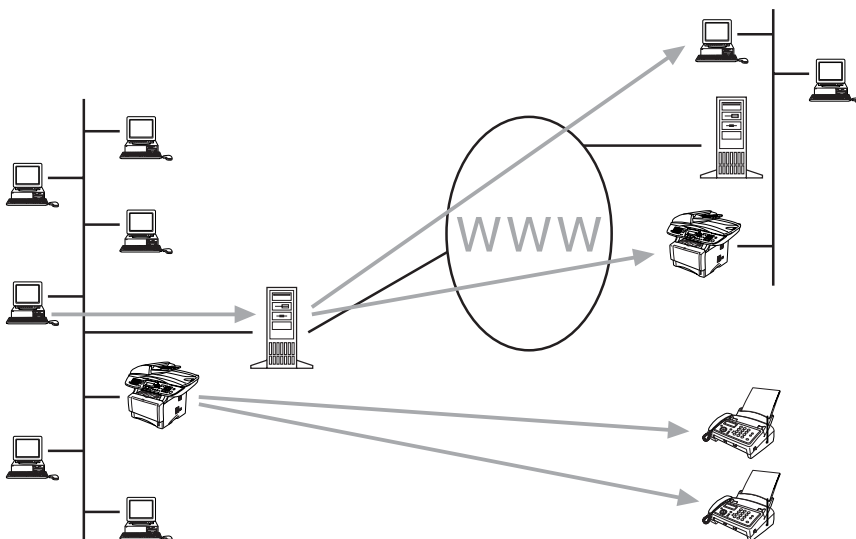

## Installing Brother Internet Fax Printing Driver

---

Insert the CDROM supplied with your Brother machine into your CD-ROM Drive. The installer screen will automatically start.



If the installer screen does not appear automatically select **Start | Run** and type **X:/setp.exe**

(**X:/** should be the drive letter of your CD ROM drive on your PC)

- 1 Select **Install Optional Applications**.
- 2 Select **Network Print Software**.
- 3 Highlight **Brother Internet Fax Printing (BFP) Driver**.
- 4 Click **Install**.

Next you will be presented with the licensing agreement, please carefully read the agreement and make the necessary choice.

During the installation you are presented with the following screen, select the default unless you have previously installed this software. If this is the case use a port number that has not been previously configured. Example BFP2

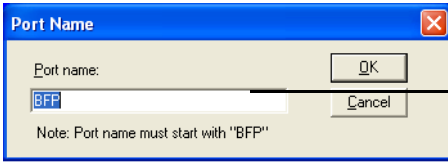

When Installing BFP on Windows® 2000/XP and Windows NT® 4.0 operating systems we recommend that you add a “:” to the end of the port name so BFP1 = BFP1:

You also need to enter certain information into the printer driver dialog screen as illustrated below.

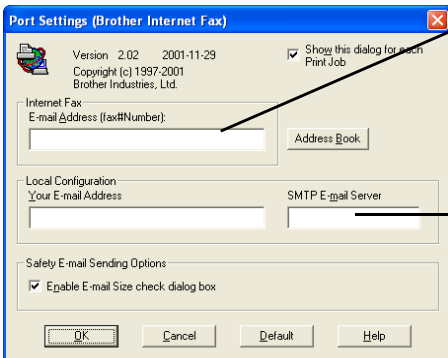

Here you can enter the default E-mail address NC-9100h or you can leave it blank.  
\* If an address is specified here this will always be used as default sending address.

This can be the host name or IP address of the E-mail server

It is very important that you enter your own E-mail address. You also need to configure the SMTP mail server IP address or host name as illustrated above.

**If in any doubt contact your Network Administrator for assistance**

# Changing the BFP Port Settings

If you have more than one networked machine with an NC-9100h Print/Fax Server you may want to change the settings of the BFP software to use an alternative machine as the network fax print server.

To alter BFP settings, select **Start | Settings | Printers** to open the Printers dialogue box. From the Printers Windows<sup>®</sup> illustrated below highlight the **Brother Internet Fax** driver and right click the mouse. From the list presented select **Properties**.

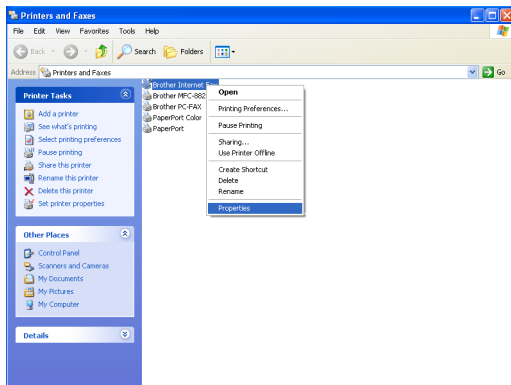

You are now presented with the screen below, which allows you to configure the BFP settings. To change the details of the print server, select the **Ports** tab.

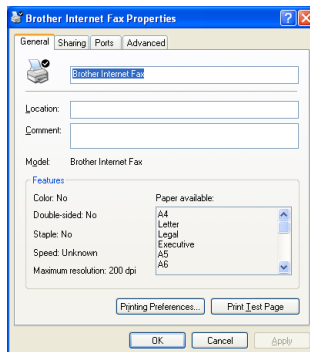

The following screen shows the current configuration to alter this configuration, press the **Configure Port...** key.

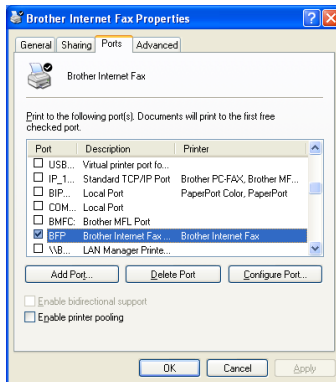

From the **Configure Port...** dialogue box you can change the settings.

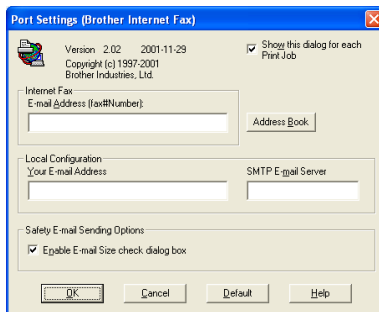

## Relay Broadcast Function

---

Before you can successfully use the NC-9100h as a network fax solution you need to switch the feature “Relay Broadcasting” ON at the machine. In addition you also need to set a “Trusted Domain” at the machine.

The easiest way to achieve this is to logon to the machine using Web Based Management. Open you favorite web browser and enter the IP address of the network machine. Enter the password of the NC-9100h Print/Fax Server to access the configuration settings.

**If you do not know the password contact you Network Administrator.**

Then browse to Internet Settings and Relay Function.

In order for the machine to receive data from the desktop and then send this information (network fax) to other fax machines the “Relay Broadcast Function” must be switched “ON”. Also you must tell the networked machine which networks can relay faxes through your machine. This is known as setting the “Trusted Domain”. For instance, if a network machine has an E-mail address of fax@brother.com and users of this machine also have E-mail addresses with the same domain name then the machine must be told to allow these users to send network faxes through the machine. This is known as the “Relay Function” and “Trusted Domains”. So we set the trusted domain as brother.com

“Trusted Domains” Provide security for your machine. In that only users from a particular domain can send faxes through your network connected machine.



“Trusted Domains” Provide security for your machine. In that only users from a particular domain can send faxes through your network connected machine.



# Uninstalling from Windows® 95/98/Me/2000/XP and Windows NT® 4.0

---

Select **Start | Settings | Control Panel** and then double click the **Add or Remove programs** icon. From the list of installed programs select the Brother Internet Fax Vx.xx as shown below then click the **Add/Remove** button.

In the case of Windows® 2000/XP and Windows NT® 4.0 you also need to remove the Brother Internet Fax Driver from the **Start | Control Panel | Add or Remove Program** properties.

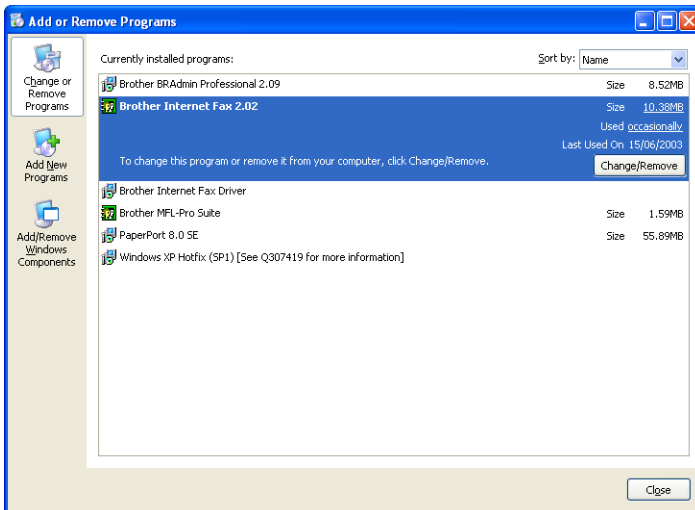

In addition to this you also need to manually remove the Brother Internet Fax Driver from the printers list.

To do this select **Start | Printers and Faxes** you are then presented with the Window illustrated below.

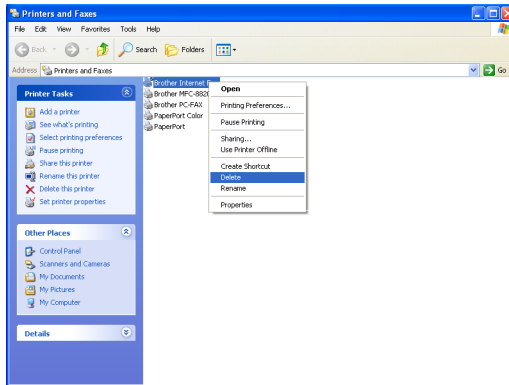

Right click the **Brother Internet Fax**, from the list click **Delete**. Accept the confirmation and the driver will be deleted.

# Using the BFP Address Book

---

This utility can administer the Fax addresses, Internet Fax addresses and E-mail address of all the contacts that you wish to use with the BFP Software. Additionally you can create Groups of contacts that you may wish to broadcast documents to.

From the **Start** menu, select **Programs, Brother, Brother MFL-Pro Suite**, and then click **Address Book**. The **Brother Address Book** dialog box will appear:

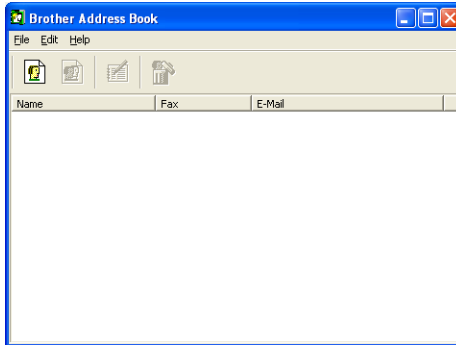

## Setting Up a Member in the Address Book

In the **Brother Address Book** dialog box you can add, edit and delete stored information for members and groups.

- 1 In the Address Book dialog box, click the  icon to add a member.  
The **Brother Address Book Member Setup** dialog box will appear:



When creating the Address Book member please select the method of default delivery.

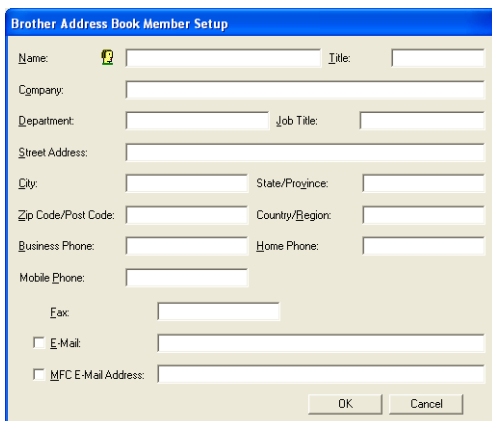

The dialog box is titled "Brother Address Book Member Setup". It contains the following fields:

- Name: [Text Field] Title: [Text Field]
- Company: [Text Field]
- Department: [Text Field] Job Title: [Text Field]
- Street Address: [Text Field]
- City: [Text Field] State/Province: [Text Field]
- Zip Code/Post Code: [Text Field] Country/Region: [Text Field]
- Business Phone: [Text Field] Home Phone: [Text Field]
- Mobile Phone: [Text Field]
- Fax: [Text Field]
- E-Mail: [Text Field]
- MFC E-Mail Address: [Text Field]

Buttons: OK, Cancel

- 2 In the Brother Address Book Member Setup dialog box, type the member's information.

**Name** and **Fax** are required fields. You can also enter the an E-mail contact address and machine address for the address book member. Click the **OK** button to save the member's information.

## Setting Up a Group for Broadcasting

---

If you repeatedly send the same PC-FAX to multiple recipients, you can combine members into a Group.

- 1 In the **Brother Address Book** dialog box, click the  icon to create a group.  
The **Brother Address Book Group Setup** dialog box appears:

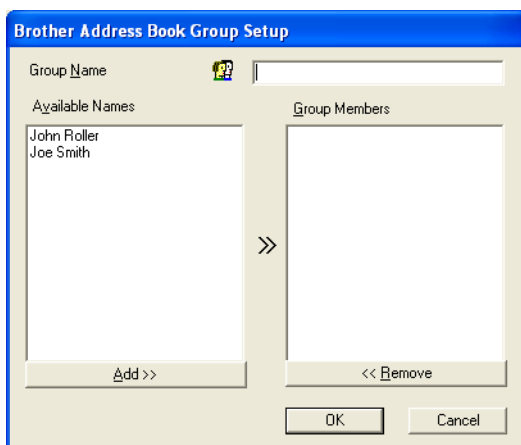

The dialog box is titled "Brother Address Book Group Setup". It contains the following elements:

- Group Name: [Text Field]
- Available Names: [List Box containing "John Roller" and "Joe Smith"]
- Group Members: [List Box]
- Navigation: Add >> (button), >> (arrow), << Remove (button)
- Buttons: OK, Cancel

- 2 Type the name of the new group in the **Group Name** field.
- 3 In the **Available Names** box, select each member to be included in the Group, and then click **Add>>**.
- 4 Members you add to the group will be listed in the **Group Members** box.
- 5 After all the members have been added, click **OK**.

## Editing Member Information

### To edit a Member or Group:

- 1 Select the Member or Group you want to edit.
- 2 Click the  Edit icon.
- 3 Edit the Member or Group information.
- 4 Click **OK** to save your changes.

## Deleting a Member or Group

### To delete a Member or Group:

- 1 Select the Member of Group you want to delete.
- 2 Click the  Delete icon.
- 3 Click **OK** when the **Delete OK?** dialog appears.

## Exporting the Address Book

You can export the address book to an ASCII text file (\*.csv).

### To export the current telephone book:

- 1 From the Address Book select **File**, point to **Export**, and then click **Text**—**OR**—Click **Vcard** and go to Step 5.
- 2 Select the data fields you wish to Export from the **Available Items** column, and then click **Add>>**.

- 3 If you are exporting to an ASCII file, select **Divide Character - Tab** or **Comma**. This selection inserts a Tab or Comma between each data field when it is Exported.
- 4 Select the **OK** button to save the data.
- 5 Type in the name of the file, and then select **Save**.
- 6 If you are creating a Vcard, you must first select the member.
- 7 Select items in the order you want them listed.

## Sending a Network Fax with BFP

---

From the application you wish to send the document from select **File | Print**. Ensure that the Brother Internet Fax Driver is selected as shown below.

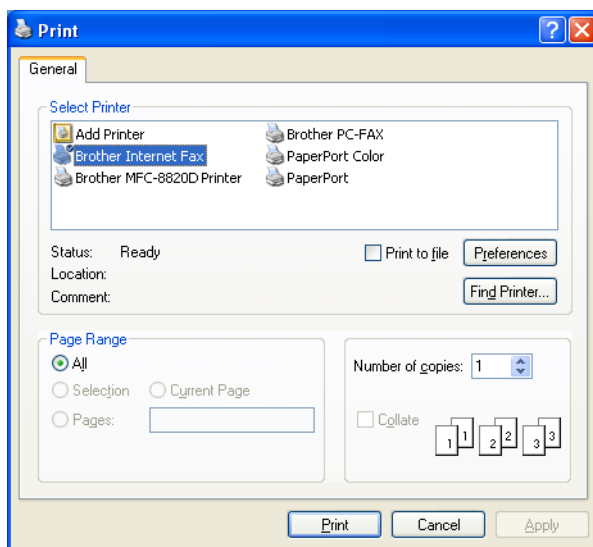

Clicking OK will start the BFP dialogue box as illustrated below. From this dialogue box you can either specify an address in the address line or select a location from the address book. If you wish to type more than one location in the address line make sure they are separated by “;”.

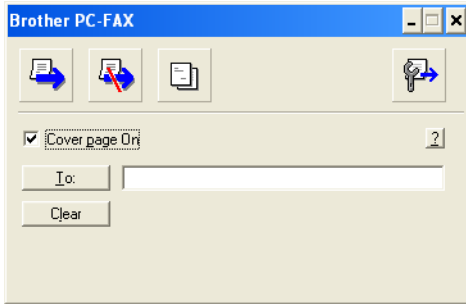

When entering a Fax Contact you must first specify the Internet Address of the machine that will send the document followed by the fax number as shown below.

`Mailmfc9650@brother.co.uk(fax#2537)`

# A Appendix

## Appendix A

---

### General Information

---

You can change the configuration of your Print/Fax server using any of the following methods.

- Brother BRAdmin Professional utility for Windows® 95/98/Me/2000/XP and Windows NT® 4.0.
- Brother Web BRAdmin Professional utility for IIS\*
- HTTP (using a web browser)
- WebJetAdmin Software

#### **BRAdmin Professional utility (Recommended)**

The Brother BRAdmin Professional utility can use the TCP/IP or IPX/SPX protocol. This utility allows you to graphically manage aspects of the network and printer. It can also be used to upgrade the firmware of the Print/Fax server.

#### **Web BRAdmin**

The Web BRAdmin software is designed to manage all LAN/WAN Brother network connected devices. By installing the Web BRAdmin server software on a computer running IIS\*, Administrators with a Web browser can connect to the Web BRAdmin server, which then communicates with the device itself. Unlike the BRAdmin Professional utility - which is designed for Windows® systems only - the Web BRAdmin server software can be accessed from any client computer with a web browser that supports Java.

Please note this software may not be included on the CD-ROM that was supplied with your Brother product. If it was not, please visit <http://solutions.brother.com/webbradmin> to learn more about this software and to download it.

IIS\* = Internet Information Server 4.0 or 5.0



## **HTTP (Recommended)**

Use your favorite web browser to connect to the Brother Print/Fax server. This will allow you to configure machine and/or Print/Fax server parameters.

## **WebJetAdmin**

Brother's Print/Fax server range is HP WebJetAdmin compatible.

# Appendix B

---

## Using Services

---

### General

A service is a resource that can be accessed by computers that wish to print to the Brother Print/Fax server. The Brother Print/Fax server provides the following predefined services (do a SHOW SERVICE command in the Brother Print/Fax server remote console to see a list of available services): Enter HELP at the command prompt for a list of supported commands.

Service (Example)	Definition
BINARY_P1	TCP/IP binary, NetBIOS service.
TEXT_P1	TCP/IP text service (adds carriage return after each line feed).
POSTSCRIPT_P1	PostScript service (switches P JL-compatible printer to PostScript mode).
PCL_P1	PCL service (switches P JL-compatible printer to PCL mode).
BRN_XXXXXX_P1_AT	AppleTalk and LPD service for Mac OS® 8.6 or later.
BRN_XXXXXX_P1	NetWare service and AppleTalk service with Quickdraw Driver for Mac OS® 8.6 - 9.1, 10.1-10.2.1 or greater (TCP/IP is enabled for backwards compatibility).

Where XXXXXX is the last six digits of the Ethernet address (for example, BRN\_310107\_P1).

# Appendix C

---

## Reloading the Print / FAX Server Firmware

---

### General

The firmware on the Print/Fax server is stored in flash memory. This means that you can upgrade the firmware by downloading the appropriate update file. To get the latest firmware update, visit the Brother Solutions web site at <http://solutions.brother.com/>

The Print / Fax server supports multiple MFC models so when inserted into the machine the version of the NC-9100h hardware is checked against the firmware of your machine. If the firmware for your NC-9100h has been superseded with a later version of firmware for your model a message is displayed on the LCD. **Please update your firmware.**



Some software versions that we provide will automatically factory reset your Print/Fax server parameters. We try to avoid doing this. However, if we add a significant new feature to our Print/Fax server, it can result in the Print/Fax server being factory reset.

Because of this, we **STRONGLY** recommend that you make a note of the current Print/Fax server configuration before you upgrade. To do this, print out a configuration page. For more information, see *Resetting the Print/Fax Server back to factory settings (Test Switch)* on page 13-4.

There are three methods of upgrading the firmware in your Brother Print/Fax server:

- 1 Use the BRAdmin Professional utility (**Recommended**)
- 2 Use the FTP protocol (**Recommended if running on Macintosh or Unix network**)
- 3 Use another system (such as a Novell or Unix system to send the new firmware file to the Print/Fax server).

# Reloading firmware using BRAdmin Professional utility

---

The BRAdmin Professional utility can be used to easily re-program your Brother Print/Fax server.

- 1 Start BRAdmin Professional utility.
- 2 Highlight the appropriate Print/Fax server. Then press select the Control menu and choose Load Firmware. You can select more than one Print/Fax server by pressing **CTRL**+<select> or **SHIFT**+<select> on each additional Print/Fax server.

There are three possible ways of sending the new software version to the print server. For whichever method you select, you must enter a password for the print server. The default password for the Print/Fax server is `access`.

- 3 TFTP PUT from this host

Use this method if you have TCP/IP already installed on your PC. BRAdmin Professional utility will use the TFTP protocol to send the new firmware data to the Print/Fax server.

- 4 TFTP GET from a server

If you have a TFTP server installed in your network (many Unix systems provide TFTP support), you may wish to use this option. The new firmware file must be located in the TFTP BOOT directory on your TFTP server. In this case, your PC makes the Print/Fax server read the firmware data from the assigned TFTP server. If you do not provide the correct file name, then the upgrade will fail. You must also ensure that the firmware file is set so that the Print/Fax server can read the file. On Unix systems you can use the **chmod** command to specify file attributes. For example, `chmod filename 666` allows the filename to be accessed by anyone. Also make sure that the TFTP service is running on your Unix server.



```
ftp> quit
```

**When you see 226 Data Transfer OK/Entering FirmWareUpdate mode, you can be sure that the firmware file is being transferred to the Print/Fax server. If you do not see this message, the file you are sending to the printer will either be ignored or the printer will print garbage.**



**You must use the “bin” command to put the FTP client into Binary communications mode. If you do not specify the **bin** command the upgrade process will not function correctly.**

# Appendix D

---

## Updating other MFC's through the Network

---

It is possible to program Brother MFC's on the network with either settings from an already programmed MFC or with data from the Brother Network PC-FAX Address Book. See Chapter 6 of the Software User's Guide on the CD-ROM.

When Brother Network PC-FAX is used from a PC that has BRAdmin Professional installed, an extra option appears in BRAdmin. By selecting a networked machine in the BRAdmin main window and right clicking it you will be presented with an extra option, **Import Auto Dial**.



If import Auto Dial option does not appear, open the Brother PC-FAX address book by selecting **Start, Programs, Brother, MFL-Pro Suite, PC-FAX Address Book**. It is necessary to run the address book utility to create an address book file.

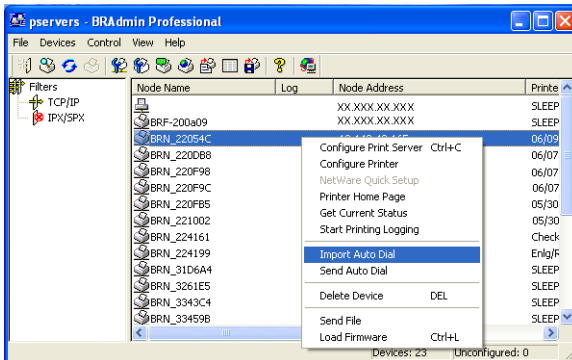

When you select this option BRAdmin reads the telephone settings from that machine (if there are any programmed) into Brother PC-FAX Address Book.

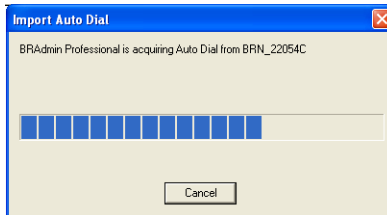

Illustrated below is the Brother Address Book, on the left are One-Touch / Speed-Dial numbers read from the machine. On the right is the Brother Address Book. It is now possible to allocate One-Touch / Speed-Dial numbers from the MFC into the Brother Address Book and also use members of the Brother Address Book and send them to the MFC. You can now make changes to the data in the Brother Network PC-FAX Address Book and click OK.

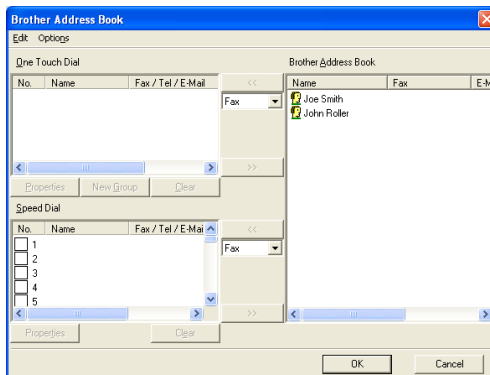

This data is then stored in the Windows® Temp Folder and can be used to update singular or multiple MFC's on the network.



Highlight singular or multiple networked Brother MFC's in the main BRAdmin window by highlighting and pressing the shift key on your keyboard. Right click the highlighted MFC's and press **Send Auto Dial**. The new data is then sent to all the highlighted MFC's.

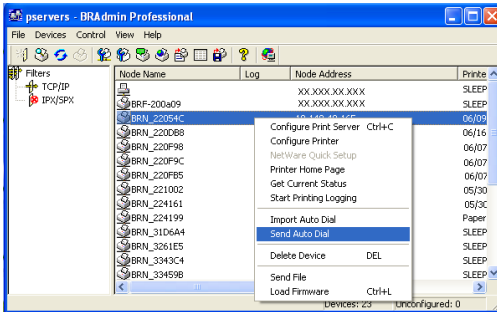

A dialog box is displayed showing the upload status of current MFC and beneath this the whole progress is displayed if updating multiple MFC's.

When the process is finished a dialog box is displayed showing which MFC's on the network have been updated.

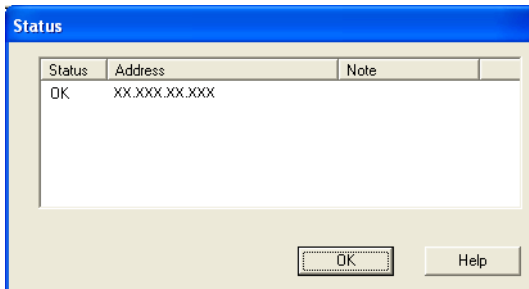

# Appendix E

---

## Specifications

---

### Operation System Support

Windows® 95/98/98SE/Me/2000/XP and Windows NT® 4.0

Unix systems supporting LPD

Mac OS® 8.6 - 9.1 /  
Mac OS® 10.1 - 10.2.1 or greater

### Protocol Support

- TCP/IP (including the following):  
RARP, BOOTP, DHCP, APIPA, NetBIOS, WINS, DNS Resolver, LPR/LPD, Port9100, SMTP/ POP3, SMB (NetBIOS/IP), IPP, FTP, SSDP, mDNS, TELNET, HTTP, SNMP, TFTP
- IPX/SPX
- AppleTalk (EtherTalk)
- DLC/LLC

### Network

10/100Base-TX Ethernet Network

### Network Printing

Windows® 95/98/Me Peer-to-Peer Printing

Windows® 2000/XP and Windows NT® 4.0  
TCP/IP Printing

Unix TCP/IP Printing

Novell NetWare Printing

Macintosh Printing (PostScript or Quick Draw over AppleTalk and TCP/IP)

### Network PC Fax send

Windows® 95/98/98SE/Me/2000/XP

Mac OS® 8.6 - 9.1 /  
Mac OS® 10.1 - 10.2.1 or greater

### Network Scanning

- B/W Resolution (TIFF-F):  
200x100, 200x200dpi
- Color Resolution (JPEG/PDF):  
150x150, 300x300, 600x600dpi



Windows® 98/98SE/Me and Windows® 2000/XP



Up to 25 clients can be connected to one machine at a time.

## Internet Fax

T.37 Simple mode

Tiff-F Profile-S

Resolution: 200x100, 200x200, 204x98,  
204x196dpi

Coding System: MH

Width: 1728 dot

Fax / E-mail / I-Fax Forwarding / Paging feature

Scan to key: E-mail / OCR / Image / File

Internet Fax Relay

E-mail Relay

Relay Broadcast



Please check the User's Guide for your Brother MFC to verify is these features are available.



SMTP/POP3 Email server required.

### Computer Requirements

(For drivers, BRAdmin Professional, Peer-to-Peer software, etc.)

#### ■ CPU:

Pentium 75MHz or Higher for Windows® 95/98/98SE/Windows NT® 4.0

Pentium 150MHz or Higher for Windows® Me

Pentium 133MHz or Higher for Windows® 2000

Pentium 233MHz or Higher for Windows® XP

#### ■ RAM:

24MB or greater (32MB recommended) for Windows® 95/98/98SE

32MB or greater (64MB recommended) for Windows® Me and Windows NT® 4.0

64MB or greater (128MB recommended) for Windows® 2000/XP

## **AppleTalk Connection**

- Computer:  
Ethernet ready Power Macintosh
- RAM:  
32MB or more (64MB or more recommended)  
for Mac OS® 8.6 - 9.2  
128MB or more (160MB or more recommended)  
for Mac OS® X 10.1 - 10.2.1 or greater
- OS:  
Mac OS® 8.6 - 9.1 /  
Mac OS® 10.1 - 10.2.1 or greater  
Open Transport 1.3 or later

## **Management Utilities**

- Web Based Management:  
Internet Explorer 5.xx or later  
Netscape Navigator 4.xx or later
- BRAdmin Professional utility  
Windows® 95/98/98SE/Me/2000/XP and  
Windows NT® 4.0
- Web BRAdmin  
Windows® 2000 Professional/Server/  
Advanced Server/XP Professional

# Function Table and Default Factory Settings

LEVEL ONE	LEVEL TWO	LEVEL THREE	OPTIONS	OPTIONS	FACTORY SETTING
6.LAN (MFC) 4.LAN (DCP)	1.Setup TCP/IP	1.BOOT Method	Auto/ Static/ RARP/ BOOTP/ DHCP		Auto
		2.IP Address	[000-255].[000-255].[000-255].[000-255]		[169].[254].[001-254].[000-255]
		3.Subnet Mask	[000-255].[000-255].[000-255].[000-255]		255.255.0.0
		4.Gateway	[000-255].[000-255].[000-255].[000-255]		000.000.000.000
		5.Host Name	BRN_XXXXXX=(last 6 figures of Ethernet address) (up to 15 characters)	BRN_XXXXXX	BRN_XXXXXX
		6.WINS Config	Auto/ Static		Auto
		7.WINS Server	(Primary) 000.000.000.000	(Secondary) 000.000.000.000	000.000.000.000
		8.DNS Server	(Primary) 000.000.000.000	(Secondary) 000.000.000.000	000.000.000.000
		9.APIPA	On/Off		On
	2.Setup Internet (MFC)	1.Mail Address	(60 characters)		brnxxxxxx@example.com
		2.SMTP Server	[000-255].[000-255].[000-255].[000-255]	Name (up to 30 characters)	000.000.000.000
		3.POP3 Server	[000-255].[000-255].[000-255].[000-255]	Name (up to 30 characters)	000.000.000.000
		4.Mailbox Name	(up to 20 characters)		
		5.Mailbox Pwd	Password:*****	Verify:*****	
	3.Setup Mail RX (MFC)	1.Auto Polling	On/ Off		On
		2.Poll Frequency	xxMin		10 Min
		3.Header	All/ Subject+From+To/ None		None
		4.Del Error Mail	On/ Off		On
		5.Notification	On/ MDN/ Off		Off
	4.Setup Mail TX (MFC)	1.Sender Subject	Internet Fax Job		
2.Size Limit		On/ Off		Off	
3.Notification		On/ Off		Off	
5.Setup Relay (MFC)	1.Rly Broadcast	On/ Off		Off	
	2.Relay Domain	RelayXX:			
	3.Relay Report	On/ Off		Off	

6.Setup Misc. (MFC) 2.(DCP)	1.Network	On/ Off *1		On
	2.Net Frame *2	Auto/ 8023/ ENET/ 8022/ SNAP		Auto
	3.AppleTalk	On/ Off		On
	4.DLC/LLC	On/ Off		On
	5.Net BIOS/IP	On/ Off		On
	6.Ethernet	Auto/ 100B-FD/ 100B-HD/ 10B-FD/ 10B-HD		Auto
	7.Time Zone	GMTXXX:XX		GMT-5:00
7.Scan to E-Mail (MFC)	1.Color	PDF/ JPEG		PDF
	2.B/W	PDF/ TIFF		PDF

\*1: 'IP Address' and 'Subnet Mask' setting will be changed by APIPA setting.

\*2: 'NET FRAME' setting is available when 'NETWARE' is 'ON'.

# INDEX

## A

AIX ..... 1-3  
AIX 4.0 ..... 1-8  
AppleTalk  
..... 7-1, 7-3, 7-8, 13-2, 13-11  
ARP ..... 1-2, 11-1, 11-6

## B

Berkeley UNIX ..... 1-1  
BFP Address Book ..... 14-9  
BFP Port ..... 14-4  
BINARY\_P1 ..... 1-2, 1-3, A-3  
BINDERY ..... 6-2  
BIP ..... 5-1  
BOOTP ..... 1-2, 11-5, 11-9  
BRAdmin ..... 11-2  
Broadcasting ..... 14-10  
Brother LPR port ..... 3-4  
Brother NetBIOS Port  
Monitor ..... 4-2, 4-4  
Brother Peer to Peer Print .... 3-4  
Browser ..... 9-2

## C

CFGTCP ..... 1-11  
Chooser ..... 7-2

## D

Desktop Printer ..... 7-5  
DHCP ..... 1-2, 11-1, 11-5  
DLC ..... 8-1  
DLC/LLC ..... 13-12  
DNS ..... 9-2  
DOMAIN ..... 4-2  
DOS ..... 4-1

## E

E-mail ..... 5-2

EtherTalk ..... 7-1, 7-3, 7-8

## F

flash memory ..... A-4  
FTP ..... 1-2, 1-11, A-4, A-6

## H

hosts ..... 3-3  
HP distributed print service .... 1-7  
HP/UX ..... 1-3, 1-7  
HTTP ..... 9-1, 11-1, A-1  
Hyper Text Transfer  
Protocol ..... 9-1

## I

IBM AS/400 ..... 1-11  
IBM LAN Server ..... 2-1  
IBM RS/6000 AIX ..... 1-8  
IIS ..... 2-2, A-1  
Internet ..... 5-1  
Internet Printing ..... 5-1  
IPP ..... 2-2, 2-4, 5-1, 5-9  
IPX ..... 6-2  
IPX/SPX ..... 11-1  
ISP ..... 5-2

## J

JetAdmin ..... 13-8

## L

LED ..... 13-3  
Linux ..... 1-1, 1-6  
lpc ..... 1-5, 1-13  
lpstat ..... 1-5

## M

Macintosh ..... 7-2  
Microsoft Internet Explorer ... 2-2  
Microsoft Internet Print  
Services ..... 2-2  
MIME ..... 5-2

## N

NDPS ..... 6-2, 6-3  
NDS ..... 6-2  
NetBIOS ..... 4-1, 13-8  
NetWare 3 ..... 6-2  
Netware 3 ..... 6-6  
NetWare 4 ..... 6-2, 6-6  
NetWare 5 ..... 6-2  
Netware GET ..... A-6  
network neighborhood ..... 4-1  
Novell ..... 13-2  
Novell Distributed Print  
  Services ..... 6-3  
Novell NetWare ..... 13-10  
NWADMIN ..... 6-2

## O

OS/2 Warp Server ..... 2-1  
OS/400 ..... 1-11

## P

password  
  ..... 1-1, 2-1, 3-1, 4-1, 5-1  
PCONSOLE ..... 6-6  
Peer to Peer Printing ..... 3-1  
Peer-to-Peer ..... 13-8  
ping ..... 13-2  
POP3 ..... 5-3  
PPD ..... 7-3, 7-7  
PRINTCAP ..... 1-2  
printcap ..... 1-4  
Printer Agent ..... 6-5  
PSERVER NLM ..... 6-12

## R

RARP ..... 11-8  
Reloading firmware ..... A-5  
RFC 1001 ..... 11-5  
rlpstat ..... 1-5

## S

sam ..... 1-7  
SCO UNIX Configuration .... 1-10  
SCOADMIN ..... 1-10  
Server Message Block ..... 4-1  
service ..... 1-3  
Simple Mail Transport  
  Protocol ..... 5-2  
smaller networks ..... 3-1  
SMB ..... 4-1  
smit ..... 1-8  
SMTP ..... 5-2, 5-7  
Sun Solaris 2.x ..... 1-9  
sysadmsh ..... 1-11  
System 8.6 ..... 7-2, 7-5

## T

TCP/IP ..... 1-1, 11-1  
TEXT\_P1 ..... 1-2, 1-3, A-3  
TFTP GET ..... A-5  
TFTP PUT ..... A-5

## U

UNIX ..... 1-1

## W

Web BRAdmin ..... A-1  
Web browser ..... 11-1  
WebJetAdmin ..... A-1  
Windows 2000  
  ..... 2-1, 5-1, 8-1, 13-10  
Windows 2000 Printing  
  ..... 2-2, 2-4  
Windows 95/98/Me ..... 3-1  
Windows NT 3.5x ..... 2-1  
Windows NT® 4.0 ..... 8-1  
Windows NT® 4.0 Printing .... 2-4  
Windows XP ..... 2-1, 5-1  
WORKGROUP ..... 4-2