

Software Developer's Manual

Raster Command Reference

QL-600/QL-710W/QL-720NW

Version 1.02

The Brother logo is a registered trademark of Brother Industries, Ltd.

Brother is a registered trademark of Brother Industries, Ltd.

© 2013-2019 Brother Industries, Ltd. All rights reserved.

Microsoft and Windows are registered trademarks of Microsoft Corporation in the United States and other countries.

Each owner whose software title is mentioned in this document has a Software License Agreement specific to its proprietary programs.

Any trade names and product names of companies appearing on Brother products, related documents and any other materials are all trademarks or registered trademarks of those respective companies.

IMPORTANT - PLEASE READ CAREFULLY

Note

This documentation ("Documentation") provides information that will assist you in controlling your Printer QL-XXX (where "XXX" is the model name).

You may use the Documentation only if you first agree to the following conditions.

If you do not agree to the following conditions, you may not use the Documentation.

Condition of Use

You may use and reproduce the Documentation to the extent necessary for your own use of your Printer Model ("Purpose"). Unless expressly permitted in the Documentation, you may not;

- (i) copy or reproduce the Documentation for any purpose other than the Purpose,
- (ii) modify, translate or adapt the Documentation, and/or redistribute it to any third party,
- (iii) rent or lease the Documentation to any third party, or,
- (iv) remove or alter any copyright notices or proprietary rights legends included within the Documentation.

No Warranty

- a. Any updates, upgrades or alteration of the Documentation or Printer Model will be performed at the sole discretion of Brother. Brother may not respond to any request or inquiry about the Documentation.
- b. THIS DOCUMENTATION IS PROVIDED TO YOU "AS IS" WITHOUT WARRANTY OF ANY KIND, WHETHER EXPRESS OR IMPLIED, INCLUDING, BUT NOT LIMITED TO, THE IMPLIED WARRANTY OF FITNESS FOR A PARTICULAR PURPOSE. BROTHER DOES NOT REPRESENT OR WARRANT THAT THIS DOCUMENTATION IS FREE FROM ERRORS OR DEFECTS.
- c. IN NO EVENT SHALL BROTHER BE LIABLE FOR ANY DIRECT, INDIRECT, PUNITIVE, INCIDENTAL, SPECIAL OR CONSEQUENTIAL DAMAGES OR ANY DAMAGES WHATSOEVER, ARISING OUT OF THE USE, INABILITY TO USE, OR THE RESULTS OF USE OF THE DOCUMENTATION OR ANY SOFTWARE PROGRAM OR APPLICATION YOU DEVELOPED IN ACCORDANCE WITH THE DOCUMENTATION.

Updates

Version	Date	Contents changed
1.01	03/21/2013	Initial version for QL-710W/ QL-720NW
1.02	01/29/2019	QL-600 added

Contents

Introduction	1
About Raster Commands	2
1. Printing Using Raster Commands	3
2. Print Data	5
2.1 Print data overview	5
2.2 Sample (analyzing the print data of the test page)	7
2.2.1 Preparation.....	7
2.2.2 Checking the print data	7
2.2.3 Explanation of print data for the test page	10
2.3 Page data details	12
2.3.1 Resolution	12
2.3.2 Page size	12
2.3.3 Feed amount	15
2.3.4 Maximum and minimum lengths	16
2.3.5 Raster line.....	17
3. Print Command List	20
4. Printing Command Details	21
NULL Invalidate	21
ESC i S Status information request	21
ESC @ Initialize.....	27
ESC i d Specify margin amount (feed amount)	27
ESC i a Switch dynamic command mode.....	28
g Raster graphics transfer	28
ESC i B Specify baud rate	29
Z Zero raster graphics	29
FF Print command.....	29
Control-Z Print command with feeding.....	29
ESC i z Print information command	30
M Select compression mode.....	31
ESC i A Specify the page number in “cut each * labels”	32
ESC i M Various mode.....	33
ESC i K Expanded mode.....	33
5. Flow Charts	34
5.1 Normal flow for USB connection	34
5.2 Error flow for USB connection (when feeding at the end of the page).....	35
5.3 Error flow for USB connection (with a concurrent printing error such as end of tape)...	36
5.4 Cooling flow for USB connection	37
5.5 Flow for setting serial connection baud rate (QL-710W / QL-720NW Only).....	38
5.6 Normal flow for serial connection (QL-710W / QL-720NW Only).....	39
5.7 Error flow for serial connection (QL-710W / QL-720NW Only).....	40
5.8 Cleaning flow for serial connection (QL-710W / QL-720NW Only).....	41
5.9 Normal Flow for Network (Standard TCP/IP port) Connection (QL-710W / QL-720NW Only)	42
Appendix A: USB Specifications	43
Appendix B: Introducing the Brother Developer Center.....	44

Introduction

This material provides the necessary information for directly controlling the Brother printer QL-XXX (where “XXX” is the model name).

This information is provided assuming that the user has full understanding of the operating system being used and basic mastery of USB and networks in a developer's environment.

Details concerning the USB interface are not described in this material. If a USB interface is being used, refer to “[Appendix A: USB Specifications](#)” to prepare the interface.

Read the model names that appear in the screens in this manual as the name of your printer.

About Raster Commands

Using raster commands a QL-XXX printer (where “XXX” is the model name) can be used to print without using our printer driver.

This operation is useful in the following situations.

- When printing from an operating system other than Windows
(Example: When printing from a Linux computer or mobile terminal)
- When adding print functions to an existing system

In addition, printing can be performed with advanced settings.

In this material, “raster” refers to binary bitmap data (collection of dots).

Refer to this material to print by sending initialization commands and control codes together with raster data to the QL-XXX printer (hereafter, referred to as “printer”).

This manual describes the procedure for adding these codes and sending the data.

1. Printing Using Raster Commands

The printing procedure is described below. For detailed flow charts, refer to [“5. Flow Charts”](#). For details on each command, refer to [“4. Printing Command Details”](#).

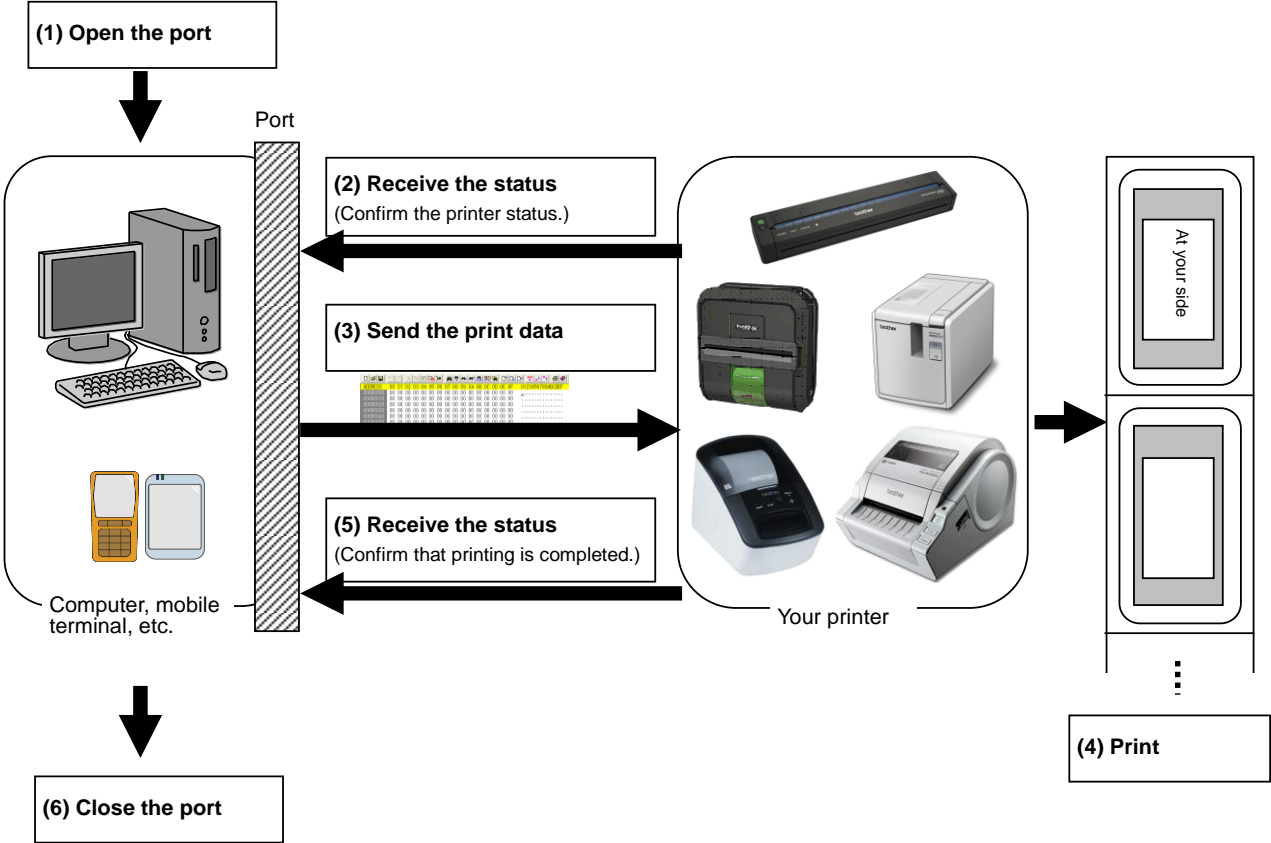

(1) Open the USB/serial/network port

Open the USB/serial/network port in the operating environment. The procedure for opening the USB/serial/network port is not described in this material.

(2) Confirm the printer status sent from the printer

The “status information request” command is sent to the printer, the status information received from the printer is analyzed, and then the status of the printer is determined.

For details on the “status information request” command and on the definitions of “status”, refer to “Status information request” in [“4. Printing Command Details”](#).

(3) Send the print data

If the status analysis confirms that media compatible with the print data is loaded into the printer and that no error has occurred, the print data is sent.

The structure of the print data is explained in the next section, [“2. Print Data”](#).

Note:

No command can be sent to the printer after the print data is transmitted and until the completion of printing is confirmed.

Even the “status information request” command cannot be sent during printing.

(4) Print the data

(5) Confirm that printing is completed

When printing is completed, the status is received from the printer.

If this status is analyzed to confirm that printing is completed, printing one page is considered finished.

If the print job has multiple pages, (2) through (4) are repeated.

(6) Close the USB/serial/network port

After all printing is finished, close the USB/serial/network port.

Note:

In order to print at high speed when a USB port is used to send uncompressed raster data, the Brother QL-XXX starts printing when it starts to receive print data, instead of waiting for a print command (concurrent printing).

For the processing flow, for example when managing errors, refer to [“5. Flow Charts”](#).

2. Print Data

2.1 Print data overview

The print data is constructed of the following: (1) initialization commands, (2) control codes, (3) raster data, and (4) print commands. If the print job consists of multiple pages, (2) through (4) are repeated.

(1) Initialization commands

Specified only once at the beginning of the job.

Sequence	Command Name	Description/Example
1	Invalidate	Sends a 200-byte invalidate command, and then resets the printer to the receiving state.
2	Initialize	Initializes for printing. 1Bh, 40h (Fixed)

(2) Control codes

Added at the beginning of each page and sent for each page.

Sequence	Command Name	Description/Example
1	Switch dynamic command mode	Switches to raster mode. 1Bh, 69h, 61h, 01h
2	Print information command	Sets the print information for the printer. For 102-mm-wide continuous length tape: 1Bh, 69h, 7Ah, 86h, 0Ah, 66h, 00h, 09h, 07h, 00h, 00h, 00h, 00h
3	Various mode	To select "Auto Cut" 1Bh, 69h, 4Dh, 40h
4	Specify the page number in "cut each * labels"	When an auto cut setting is effective, specify the number of sheets for auto cut. For each sheets, 1Bh, 69h, 41h, 01h
5	Expanded mode	To select "Cut at End" flag 1Bh, 69h, 4Bh, 08h
6	Specify margin amount	Specifies the amount of the margins. For 3 mm margins: 1Bh, 69h, 64h, 23h, 00h
7	Select compression mode	(QL-710W / QL-720NW Only) Selects the compression mode for raster graphics. To send the data compressed to TIFF format: 4Dh, 02h

(3) Raster data

Repeated for each page in the print job.

Sequence	Command Name	Description/Example
-	Raster graphics transfer	Sends image data as commands.
-	Zero raster graphics	Sends image data for 1 blank line as a compression command. (Valid only when TIFF is selected as the compression mode) 5Ah (Fixed)

(4) Print commands

Specified at the end of the page.

Sequence	Command Name	Description/Example
-	Print command	Specifies at the end of a page that is not the last page. 0Ch
-	Print command with feeding	Specifies at the end of the last page. 1Ah (Fixed)
Last	Switch dynamic command mode	(QL-600 Only) Resets the command mode of the printer to default mode. 1Bh, 69h, 61h, FFh

2.2 Sample (analyzing the print data of the test page)

Based on print data created by the printer driver, descriptions of the commands introduced in the previous chapter are provided here.

As an example, we will check the print data created when the **[Print Test Page]** button in the printer Properties dialog box is clicked to print the test page.

Since the print data differs depending on the print settings of the printer, refer to this procedure and try creating print data with various print settings.

Furthermore, this procedure is for the Windows® 7 operating environment. A similar procedure can be performed if you are using a different operating system.

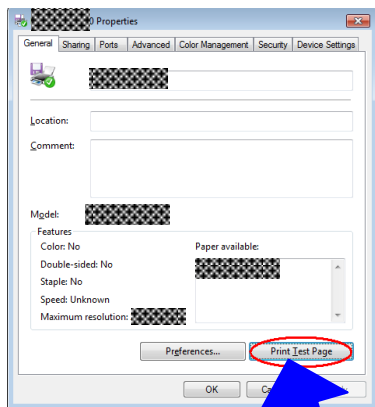

Printer Properties

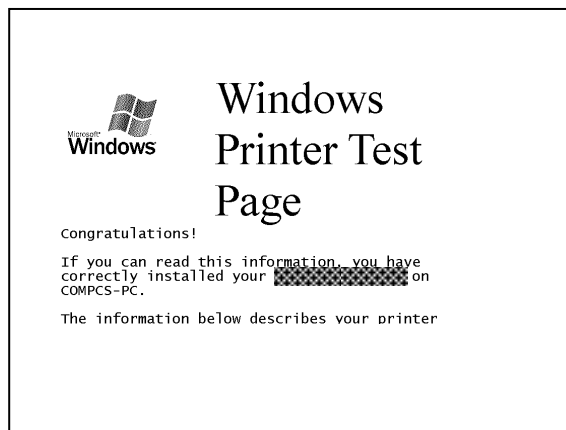

Test page

2.2.1 Preparation

Install the two listed below.

- Printer driver of the Brother QL-XXX
- Binary file editor

The data that we will analyze in this sample is a binary file.

Therefore, use a binary file editor to display and check the contents of the binary file.

2.2.2 Checking the print data

The procedure for checking the print data is provided below.

Step 1: Change the port of the printer to "FILE:".

Step 2: Print the desired item (in this case, the test page), and then specify the file name.

Step 3: Open the created file in the binary file editor to check it.

Step 1: Change the port of the printer to “FILE:”.

Open the **Printers and Faxes** folder, and then right-click the printer to display the Properties dialog box. In the Properties dialog box, click the **[Ports]** tab, select the “**FILE:**” check box, and then click the **[Apply]** button.

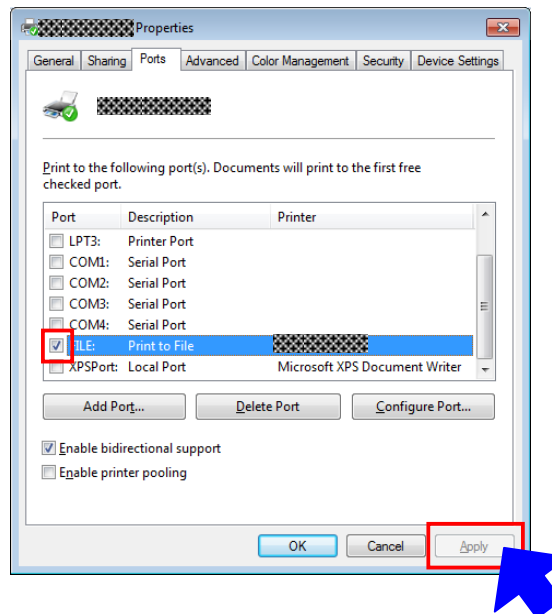

[Ports] tab of the printer Properties dialog box

Step 2: Print the item (in this case, the test page), and then specify the file name.

For this sample, print the test page with the default print settings, which were specified immediately after the printer driver was installed.

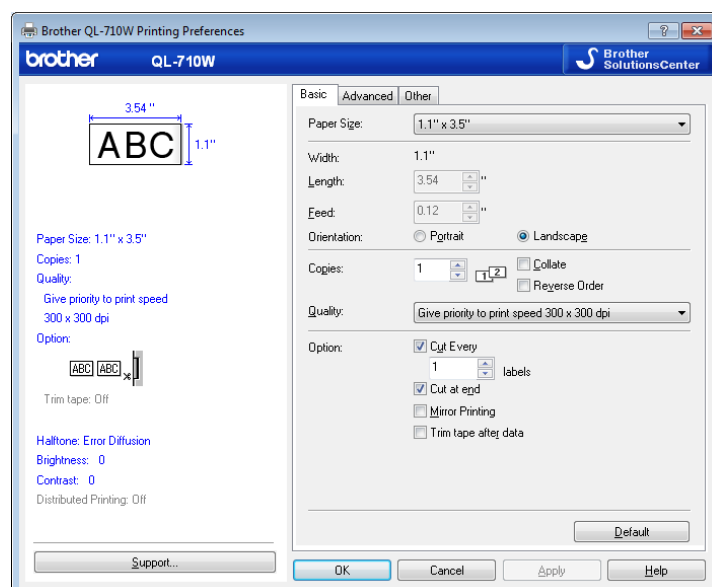

Default settings immediately after installation of the printer driver

2.2.3 Explanation of print data for the test page

The print data for the test page outputted in the previous section is described below.

The following illustration shows the print data created in section “[2.2.1 Preparation](#)” opened in the binary file editor.

* For QL-600, switch dynamic command mode (1B 69 61 FF) after position 12.

Print data

Descriptions for the numbers in the print data on the previous page are provided in the following table.

For details on each command, refer to [“4. Printing Command Details”](#).

No.	Command Name	Description
1	Invalidate	A 200-byte invalidate command is sent.
2	Initialize	The “initialize” command is sent.
3	Switch dynamic command mode	The printer is switched to raster mode. Send this command before sending raster data to the printer.
4	Job ID setting commands	(QL-710W / QL-720NW Only) Internal specification commands Since this is a command for outputting with the commercial version driver, it is unnecessary for the user to send this command.
5	Print information command	Media size information for the print data is sent. This is the command for “1.1” x 3.5” (29 mm x 90 mm)” die-cut labels.
6	Various mode (1Bh+69h+4Dh+00H)	This is the command for specifying settings such as cut options. Here, “auto cut” is specified.
7	Specify the page number in “cut each * labels”	The number of pages printed before automatically cutting is specified.
8	Expanded mode	This is the command for specifying expanded functions. Here, “cut at end” is specified.
9	Specify margin amount	Since a margin amount cannot be specified with die-cut labels, this command is sent with a margin amount of 0.
10	Select compression mode	(QL-710W / QL-720NW Only) TIFF compression mode is selected.
11	Raster data	Raster data continues.
12	Print command with feeding	Since one page will be printed, this is sent at the end of the first page.
13	Switch dynamic command mode	(QL-600 Only) This command resets to default mode that is switched by No.3. Send this command after [Print command with feeding] is sent.

2.3 Page data details

2.3.1 Resolution

Resolution	Height-to-Width Proportion
300 dpi high, 300 dpi wide	1:1
600 dpi high, 300 dpi wide	2:1

2.3.2 Page size

(a) Continuous length tape

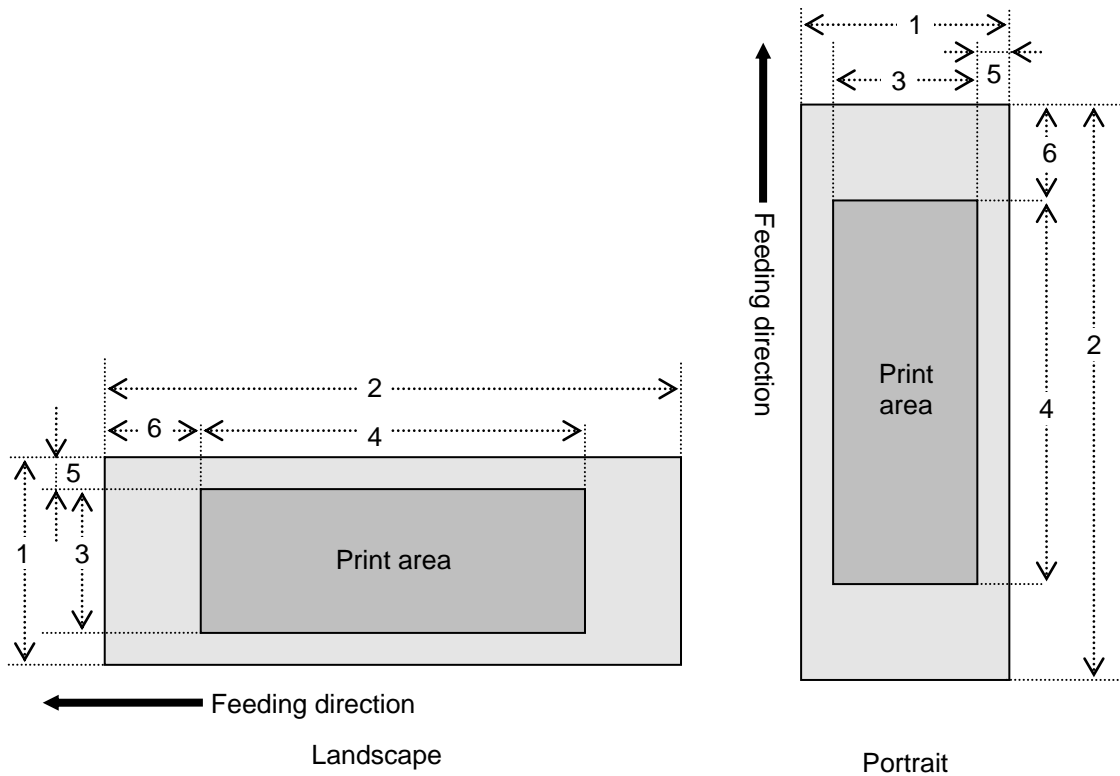

- Number 1 Width
- 3 Print area width (maximum printing width)
- 5 Width offset

- 2 Length
- 4 Print area length
- 6 Length offset

ID	Tape Size	Designation	1	2	3	4	5	6
257	12 mm	12 mm 0.47"	12.0 mm 142 dots	→ 2.3.4	9.0 mm 106 dots	→ 2.3.4	1.5 mm 18 dots	→ 2.3.3
258	29 mm	29 mm 1.1"	29.0 mm 342 dots	→ 2.3.4	25.9 mm 306 dots	→ 2.3.4	1.5 mm 18 dots	→ 2.3.3
264	38mm	38 mm 1.4"	38.0 mm 449 dots	→ 2.3.4	35.0 mm 413 dots	→ 2.3.4	1.5 mm 18 dots	→ 2.3.3
262	50 mm	50 mm 1.9"	50.0 mm 590 dots	→ 2.3.4	46.9 mm 554 dots	→ 2.3.4	1.5 mm 18 dots	→ 2.3.3
261	54 mm	54 mm 2.1"	53.8 mm 636 dots	→ 2.3.4	50.0 mm 590 dots	→ 2.3.4	1.9 mm 23 dots	→ 2.3.3
259	62 mm	62 mm 2.4"	62.0 mm 732 dots	→ 2.3.4	58.9 mm 696 dots	→ 2.3.4	1.5 mm 18 dots	→ 2.3.3

(b) Die-cut labels

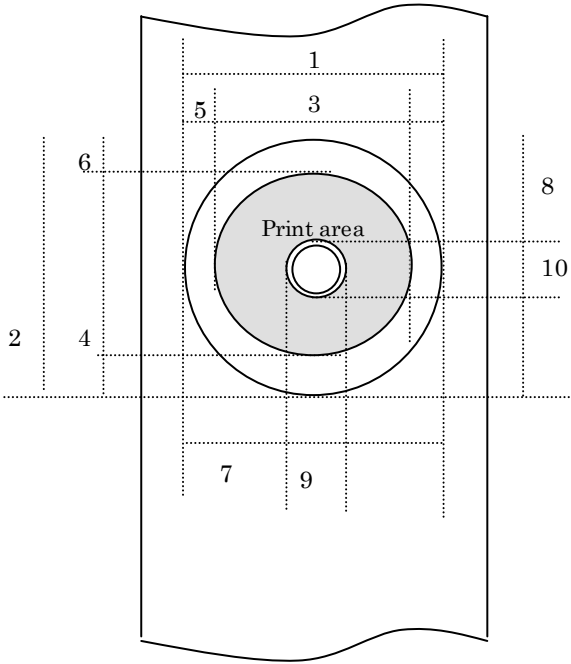
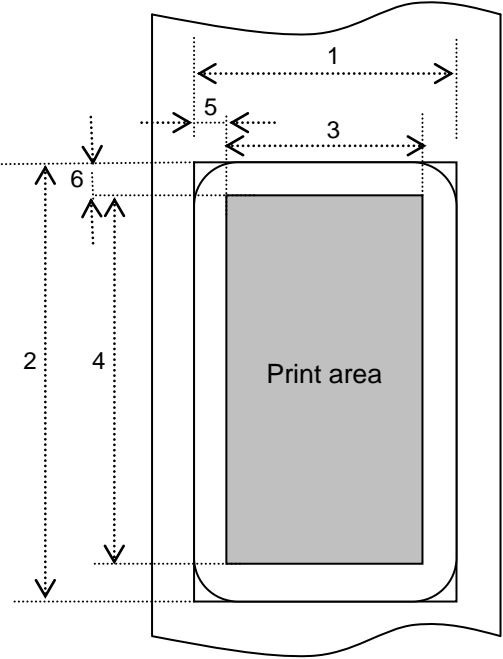

- Number 1 Width
- 3 Print area width (maximum printing width)
- 5 Width offset
- 7 Width offset of masked area
- 9 Width of masked area

- 2 Length
- 4 Print area length
- 6 Length offset
- 8 Length offset of masked area
- 10 Length of masked area

ID	Label Size	1	2	3	4	5	6
269	17 mm x 54 mm 0.66" x 2.1"	17.0 mm 201 dots	53.9 mm 636 dots	14.0 mm 165 dots	47.9 mm 566 dots	1.5 mm 18 dots	3.0 mm 35 dots
270	17 mm x 87 mm 0.66" x 3.4"	17.0 mm 201 dots	86.9 mm 1026 dots	14.0 mm 165 dots	80.9 mm 956 dots	1.5 mm 18 dots	3.0 mm 35 dots
370	23 mm x 23 mm 0.9" x 0.9"	23.0 mm 272 dots	23.0 mm 272 dots	20.0 mm 236 dots	17.1 mm 202 dots	1.5 mm 18 dots	3.0 mm 35 dots
358	29 mm x 42 mm 1.1" x 1.6"	29.0 mm 342 dots	41.9 mm 495 dots	25.9 mm 306 dots	36.0 mm 425 dots	1.5 mm 18 dots	3.0 mm 35 dots
271	29 mm x 90 mm 1.1" x 3.5"	29.0 mm 342 dots	89.8 mm 1061 dots	25.9 mm 306 dots	83.9 mm 991 dots	1.5 mm 18 dots	3.0 mm 35 dots
272	38 mm x 90 mm 1.4" x 3.5"	38.0 mm 449 dots	89.8 mm 1061 dots	35.0 mm 413 dots	83.9 mm 991 dots	1.5 mm 18 dots	3.0 mm 35 dots
367	39 mm x 48 mm 1.5" x 1.8"	39.0 mm 461 dots	47.8 mm 565 dots	36.0 mm 425 dots	41.9 mm 495 dots	1.5 mm 18 dots	3.0 mm 35 dots
374	52 mm x 29 mm 2" x 1.1"	52.0 mm 614 dots	28.9 mm 341 dots	48.9 mm 578 dots	22.9 mm 271 dots	1.5 mm 18 dots	3.0 mm 35 dots
383	60 mm x 86 mm 2.3" x 3.4"	60.0 mm 708 dots	86.8 mm 1024 dots	56.9 mm 672 dots	80.8 mm 954 dots	1.5 mm 18 dots	3.0 mm 35 dots
274	62 mm x 29 mm 2.4" x 1.1"	62.0 mm 732 dots	28.9 mm 341 dots	58.9 mm 696 dots	22.9 mm 271 dots	1.5 mm 18 dots	3.0 mm 35 dots
275	62 mm x 100 mm 2.4" x 3.9"	62.0 mm 732 dots	99.8 mm 1179 dots	58.9 mm 696 dots	93.9 mm 1109 dots	1.5 mm 18 dots	3.0 mm 35 dots
362	12 mm Dia 0.47" Dia	12.0 mm 142 dots	12.0 mm 142 dots	8.0 mm 94 dots	8.0 mm 94 dots	2.0 mm 24 dots	2.0 mm 24 dots
363	24 mm Dia 0.94" Dia	24.0 mm 284 dots	24.0 mm 284 dots	20.0 mm 236 dots	20.0 mm 236 dots	2.0 mm 24 dots	2.0 mm 24 dots
273	58 mm Dia 2.2" Dia	58.3 mm 688 dots	58.3 mm 688 dots	52.3 mm 618 dots	52.3 mm 618 dots	3.0 mm 35 dots	3.0 mm 35 dots

ID	7	8	9	10
273	19.64 mm 201 dots	53.9 mm 636 dots	14.0 mm 165 dots	47.9 mm 566 dots

*1 The number of dots in the table is for 300 dpi; it is difference in the high-resolution mode.

*2 Margins of 3 mm (1.5 mm x 2) horizontally and 3 mm (1.5 mm x 2) vertically are added to a diameter of 16 mm.

2.3.3 Feed amount

The feed amount (left and right margins) is defined below.

Type	Minimum Margin Setting	Maximum Margin Setting
Continuous length tape	3 mm 0.12" 35 dots	127 mm 5" 1500 dots
Die-cut labels	The length offset indicated in "(b) Die-cut labels" of "2.3.2 Page size" is used. However, set "0" as the value of the "specify margin amount" command.	

*1 The number of dots in the table is for 300 dpi; it is difference in the high-resolution mode.

2.3.4 Maximum and minimum lengths

The maximum and minimum lengths are defined below.

Type	Minimum Length	Maximum Length
Continuous length tape	12.7 mm 150 dots	1000 mm 11811 dots
Die-cut labels	Fixed	Fixed

*1 The number of dots in the table is for 300 dpi; it is difference in the high-resolution mode.

2.3.5 Raster line

As shown below, the parts with data to be printed are converted with “raster graphics transfer”, and the parts with no data are converted with “zero raster graphics”. On the actual tape, margins (feed) are added specified with “various mode” at the beginning and the end.

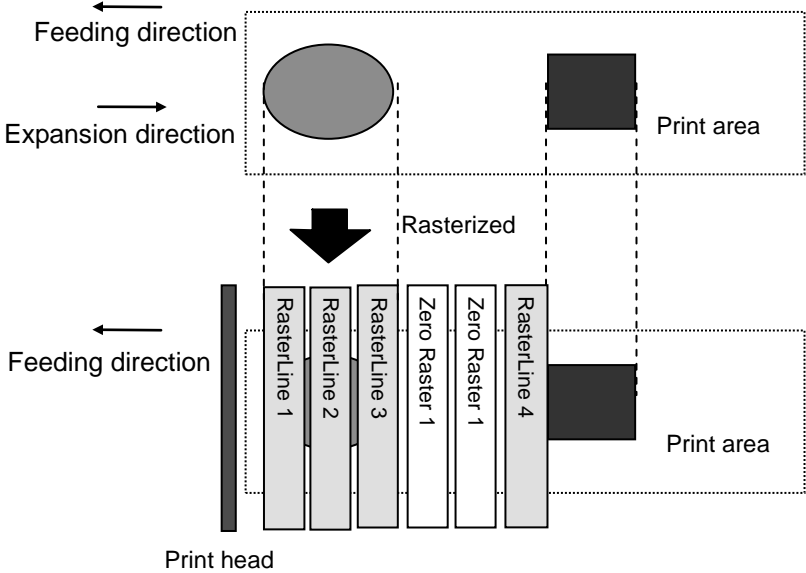

The following shows the relationship between the raster graphics parameters and the pixels.

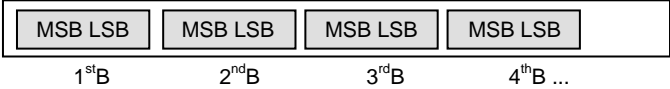

Total number of pins: 720 pins

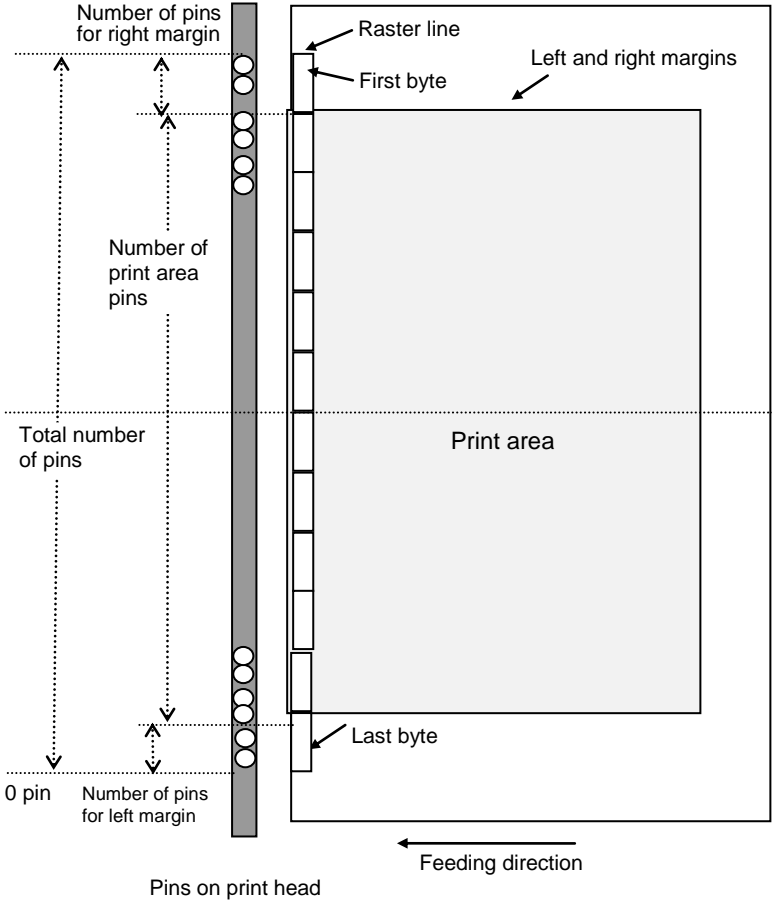

Continuous length tape:

Tape Size	Number of Pins for Left Margin	Number of Print Area Pins	Number of Pins for Right Margin	Number of Bytes for Raster Graphics Transfer
12 mm	585	106	29	90
29 mm	408	306	6	90
38 mm	295	413	12	90
50 mm	154	554	12	90
54 mm	130	590	0	90
62 mm	12	696	12	90

Die-cut labels:

Label Size	Number of Pins for Left Margin	Number of Print Area Pins	Number of Pins for Right Margin	Number of Bytes for Raster Graphics Transfer
17mm x 54mm	555	165	0	90
17mm x 87mm	555	165	0	90
23mm x 23mm	442	236	42	90
29mm x 42mm	408	306	6	90
29mm x 90mm	408	306	6	90
38mm x 90mm	295	413	12	90
39mm x 48mm	289	425	6	90
52mm x 29mm	142	578	0	90
60mm x 86mm	24	672	24	90
62mm x 29mm	12	696	12	90
62mm x 100mm	12	696	12	90
12mm Dia	513	94	113	90
24mm Dia	442	236	42	90
58mm Dia	51	618	51	90

3. Print Command List

ASCII Code	Binary Code	Description
NULL	00	Invalidate
ESC i S	1B 69 53	Status information request
ESC @	1B 40	Initialize
ESC i d	1B 69 64	Specify margin amount (feed amount)
ESC i a	1B 69 61	Switch dynamic command mode
g	67	Raster graphics transfer
ESC i B	1B 69 42	Specify baud rate
Z	5A	Zero raster graphics
FF	0C	Print command
Control-Z	1A	Print command with feeding
ESC i z	1B 69 7A	Print information command
M	4D	Select compression mode
ESC i A	1B 69 41	Specify the page number in "cut each * labels"
ESC i M	1B 69 4D	Various mode
ESC i K	1B 69 4B	Expanded mode

4. Printing Command Details

NULL Invalidate

ASCII:	NULL
Hexadecimal:	00

Description

- Skipped
- If data transmission is to be stopped midway, send the “initialize” command after sending the “invalidate” command for the appropriate number of bytes to return to the receiving state, where the print buffer is cleared.

ESC i S Status information request

ASCII:	ESC	i	S
Hexadecimal:	1B	69	53

Description

- When a status information request is sent to the printer, a fixed size of 32 bytes is returned as a response from the printer. For details on these 32 bytes, refer to the following page.

Note

Before sending print data to the printer, this command should be sent once. Since error information is automatically sent by the printer during printing, do not send this command while printing.

For details on transmission of the status, refer to “[5. Flow Charts](#)”.

Number	Offset	Size	Name	Value/Reference
1	0	1	Print head mark	Fixed at 80h
2	1	1	Size	Fixed at 20h
3	2	1	Reserved	Fixed at "B" (42h)
4	3	1	Series code	Fixed at "4" (34h)
5	4	1	Model code	QL-710W: Fixed at "6" (36h) QL-720NW: Fixed at "7" (37h) QL-600: Fixed at "G" (47h)
6	5	1	Reserved	Fixed at "0" (30h)
7	6	1	Reserved	Fixed at "0" (30h)
8	7	1	Reserved	Fixed at "00h"
9	8	1	Error information 1	Refer to table (1) below.
10	9	1	Error information 2	Refer to table (2) below.
11	10	1	Media width	Refer to table (3) below.
12	11	1	Media type	Refer to table (4) below.
13	12	1	Reserved	Fixed at 00h
14	13	1	Reserved	Fixed at 00h
15	14	1	Reserved	Fixed at 3Fh
16	15	1	Mode	Value specified where the "various mode" command 00h if not specified
17	16	1	Reserved	Fixed at 00h
18	17	1	Media length	Refer to table (3) below.
19	18	1	Status type	Refer to table (5) below.
20	19	1	Phase type	Refer to table (6) below.
21	20	1	Phase number (higher order bytes)	
22	21	1	Phase number (lower order bytes)	
23	22	1	Notification number	Refer to table (7) below.
24	23	1	Reserved	Fixed at 00h
25	24	8	Reserved	Fixed at 00h

(1) Error information 1

Flag	Mask	Definition
Bit 0	01h	“No media” error
Bit 1	02h	“End of media” error (only for die-cut labels)
Bit 2	04h	Cutter jam
Bit 3	08h	(Not used)
Bit 4	10h	Printer in use
Bit 5	20h	Printer turned off
Bit 6	40h	High-voltage adapter (not used)
Bit 7	80h	Fan motor error (not used)

(2) Error information 2

Flag	Mask	Definition
Bit 0	01h	“Replace media” error
Bit 1	02h	“Expansion buffer full” error
Bit 2	04h	Communication error
Bit 3	08h	“Communication buffer full” error (not used)
Bit 4	10h	“Cover open” error
Bit 5	20h	Cancel key (not used)
Bit 6	40h	Media cannot be fed (also when the media end is detected)
Bit 7	80h	System error

(3) Media width and length

The media width and length is described in millimeters. 0~255 (0 to FFh)

(a) Continuous length tape

* Media Width: The tape width is indicated in millimeters.

* Media Length: Fixed at 00h

Media	Media Width	Media Length
12 mm	12	0
29 mm	29	0
38 mm	38	0
50 mm	50	0
54 mm	54	0
62 mm	62	0

(b) Die-cut labels

* Media Width: The width of the die-cut section is indicated.

* Media Length: The length of the die-cut section is indicated.

Media	Media Width	Media Length
17 mm x 54 mm	17	54
17 mm x 87 mm	17	87
23 mm x 23 mm	23	23
29 mm x 42 mm	29	42
29 mm x 90 mm	29	90
38 mm x 90 mm	38	90
39 mm x 48 mm	39	48
52 mm x 29 mm	52	29
60 mm x 86 mm	60	87
62 mm x 29 mm	62	29
62 mm x 100 mm	62	100
12 mm Dia	12	12
24 mm Dia	24	24
58 mm Dia	58	58

(4) Media type

Media Type	Value	Description
No media	00h	Used as print information when the media type is not indicated.
Continuous length tape	4Ah	Used for both paper and film.
Die-cut labels	4Bh	Used for both paper and film.

(5) Status type

Status Type	Value
Reply to status request	00h
Printing completed	01h
Error occurred	02h
Turned off	04h
Notification	05h
Phase change	06h
(Not used)	08h to 20h
(Reserved)	21h to FFh

If an error occurred during printing, the printer returns the error status.

(6) Phase type and phase number

If the phase number is not used, both are fixed at 00h.

Phase State	Phase Type
Receiving state	00h
Printing state	01h

Receiving state

Phase	Value (Dec.)	Higher Order Bytes	Lower Order Bytes
Waiting to receive	0	00h	00h

Printing state

Phase	Value (Dec.)	Higher Order Bytes	Lower Order Bytes
Printing	0	00h	00h

- When the printer is turned on, it is in the receiving state. When printing begins, it changes to the “printing” phase (phase type: printing state; phase number: printing), and the printer sends that phase status to the computer. When printing has finished, the printer sends the “receiving state” phase status (phase type: receiving state; phase number: waiting to receive) to the computer. Unless an error occurs during printing, the printer sends the “printing completed” status.
- With concurrent printing, printing starts even if a print command has not been sent from the computer in order to print at high speed. At this time, care should be taken since the “printing” and “waiting to receive” phase statuses will be sent. (Refer to [“5. Flow Charts”](#).)

(7) Notification number

Notification	Value
Not available	00h
Cooling (started)	03h
Cooling (finished)	04h

ESC @ Initialize

ASCII:	ESC	@
Hexadecimal:	1B	40

Description

- Initializes mode settings.
- Also used to cancel printing.

ESC i d Specify margin amount (feed amount)

ASCII:	ESC	i	d	{n1}	{n2}
Hexadecimal:	1B	69	64	{n1}	{n2}

Description

- Specifies the amount of the margins.
- Margin amount (dots)= $n1+n2*256$
- With die-cut labels, the margin amount at the ends of the printed area is 0.

(a) Continuous length tape

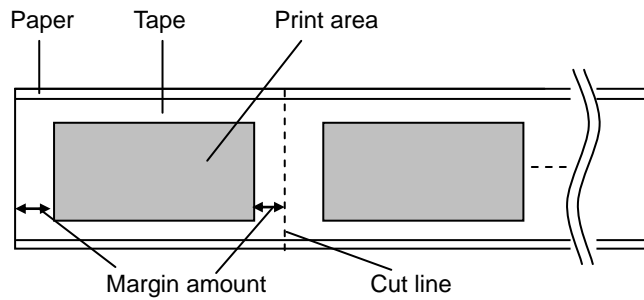

(b) Die-cut labels

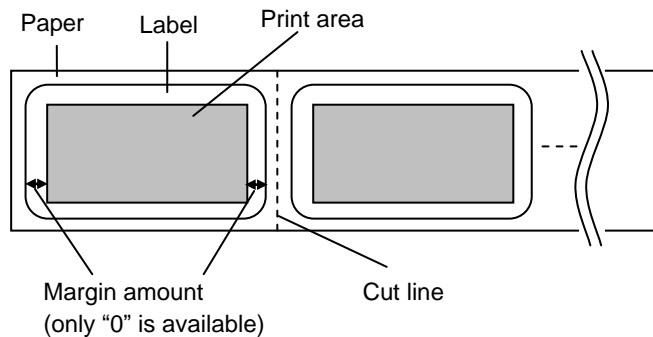

ESC i a Switch dynamic command mode

ASCII:	ESC	i	a	{n1}
Hexadecimal:	1B	69	61	{n1}

Parameters

Definitions of {n}:

0: ESC/P mode (default of QL-710W / QL-720NW) (QL-710W / QL-720NW Only)

1: Raster mode (Be sure to switch to this mode.) (default of QL-600)

3: P-touch Template mode (QL-710W / QL-720NW Only)

FF: Mode set as default

Description

- Dynamically switches between the printer's command modes. A printer that receives this command operates in the specified command mode until the printer is turned off.
- The printer must be switched to raster mode before raster data is sent to it. Therefore, send this command to switch the printer to raster mode.

g Raster graphics transfer

ASCII:	g	{s}	{n}	{d1}	...	{dn}
Hexadecimal:	67	{s}	{n}	{d1}	...	{dn}

Parameters

{s} 00h

{n} Number of bytes of raster data (d1 to dh)

However, use the following value if no compression is specified as the compression mode.

n=104

{d1~dn} Raster data.

ESC i B Specify baud rate

ASCII:	ESC	i	B	{n1}	{n2}
Hexadecimal:	1B	69	42	{n1}	{n2}

Parameters

Setting= $n1+n2*256$

Setting: 96=9600 bps, 576=57600 bps, 1152=115200 bps

Description

- Changes the communications baud rate for the printer. The manufacturer's default setting is 9600 bps.

Z Zero raster graphics

ASCII:	Z
Hexadecimal:	5A

Description

- Fills raster line with 0 data.

FF Print command

ASCII:	FF
Hexadecimal:	0C

Description

- Used as a print command at the end of pages other than the last page when multiple pages are printed.

Control-Z Print command with feeding

ASCII:	Control-Z
Hexadecimal:	1A

Description

- Used as a print command at the end of the last page.

ESC i z Print information command

ASCII:	ESC	i	z	{n1}	{n2}	{n3}	{n4}	{n5}	{n6}	{n7}	{n8}	{n9}	{n10}
Hexadecimal:	1B	69	7A	{n1}	{n2}	{n3}	{n4}	{n5}	{n6}	{n7}	{n8}	{n9}	{n10}

Description

- Specifies the print information.
- Definitions of {n1} through {n10}

{n1}:	Valid flag; Specifies which values are valid 0x02: Media type 0x04: Media width 0x08: Media length 0x40: Priority given to print quality 0x80: Printer recovery always on
{n2}:	Media type Continuous length tape: 0Ah Die-cut labels: 0Bh
{n3}:	{n3}: Media width (mm)
{n4}:	{n4}: Media length (mm) For the media of width 62 mm × length 100 mm, specify as n3=3Eh and n4=64h.
{n5-n8}:	Raster number = $n8*256*256*256 + n7*256*256 + n6*256 + n5$ If the media is not correctly loaded into the printer when the media type, media width and media length of valid flag {n1} are set to “ON”, an error status is returned. (Bit 0 of “ (2) Error information 2 ” is set to “ON”.)
{n9}:	Starting page: 0 Other pages: 1
{n10}:	Fixed at 0

M Select compression mode

ASCII:	M	{n}
Hexadecimal:	4D	{n}

Parameters

Definitions of {n}

- 0 No-compression mode (Enabled)
- 1 Reserved (Disabled)
- 2 TIFF (Enabled)

Description

- Selects the compression mode. Data compression is available only for data in raster graphic transfer.

[TIFF(Pack Bits)]

- 1-byte units
- If the same data is repeated, the number of data units and that 1 byte of data are specified.
If different data is in a series, the number of data items and all of the different data are specified.
- If the same data is repeated, the number of data units is specified as the actual number minus 1, expressed as a negative number.
If different data is in a series, the number of data units is specified as the number of bytes minus 1, expressed as a positive number.
- If the above process results in more than 90 bytes of compressed data, the data is treated as being all different. As a result, the data will be 91 bytes, including the 1 byte that specifies the data length.

Example

1 raster of raster graphics transfer:

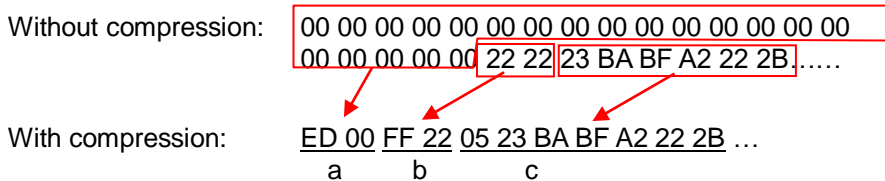

- a. Since “00h” is repeated for 20 bytes, 20d -> 19d -> 13h changed into a negative number is EDh. Therefore: ED 00
- b. Since “22h” is repeated for 2 bytes, 2d -> 1d -> 1h changed into a negative number is FFh. Therefore: FF 22
- c. The following 6 bytes remain unchanged. 6d -> 5d -> 5h. Therefore: 05 23 BA BF A2 22 2B

Continue for the remaining number of bytes for the uncompressed data. Even if 00h continues until the end, it cannot be omitted.

Explanation of “TIFF compression mode”

With compression, the data for the “raster graphics transfer” command is based on 90 bytes of the total number of pins (720). As shown below, with no compression, the sum of the number of offset pins and the number of pins within the print area is the byte data. However, with compression, the number of unused pins is also added to the data. In other words, with compression, this becomes 90 bytes when it is expanded by the printer, regardless of the tape width.

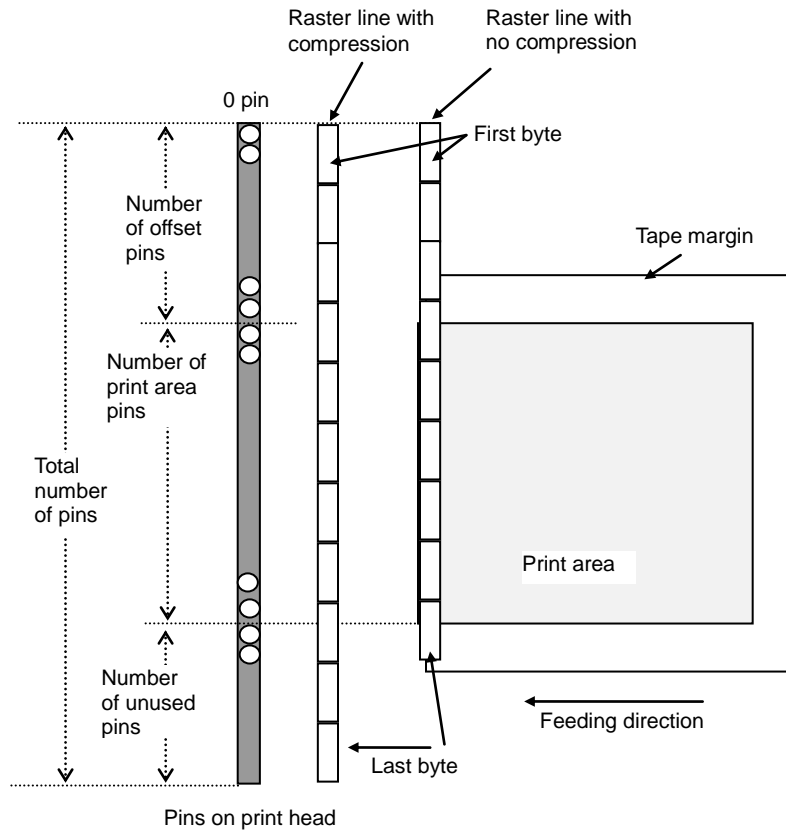

ESC i A Specify the page number in “cut each * labels”

ASCII:	ESC	i	A	{n}
Hexadecimal:	1B	69	41	{n}

Parameters

- Definitions of {n}
- Page number = n1 (1 - 255)
- Default is 1 (cut each label).

Description

When “auto cut” is specified, you can specify page number (1 - 255) in “cut each * labels”.

ESC i M Various mode

ASCII:	ESC	i	M	{n}
Hexadecimal:	1B	69	4D	{n}

Parameters

Definitions of {n}

The meaning of each bit in a 1-byte parameter is described below.

1 ~ 6bit: Not used

7bit: Auto cut 1: Auto cut 0:No auto cut

8bit: Not used

ESC i K Expanded mode

ASCII:	ESC	i	K	{n}
Hexadecimal:	1B	69	4B	{n}

Parameters

Definitions of {n}

The meaning of each bit in a 1-byte parameter is described below.

1 ~ 3bit: Not used

4bit: Cut at end 1:Cut at end (default) 0:Not cut at end

5,6bit: Not used

7bit: High resolution printing

1: It prints at 600 dpi in the paper length direction

0: It prints at 300 dpi in the paper length direction. (default)

8bit: Not used

5. Flow Charts

5.1 Normal flow for USB connection

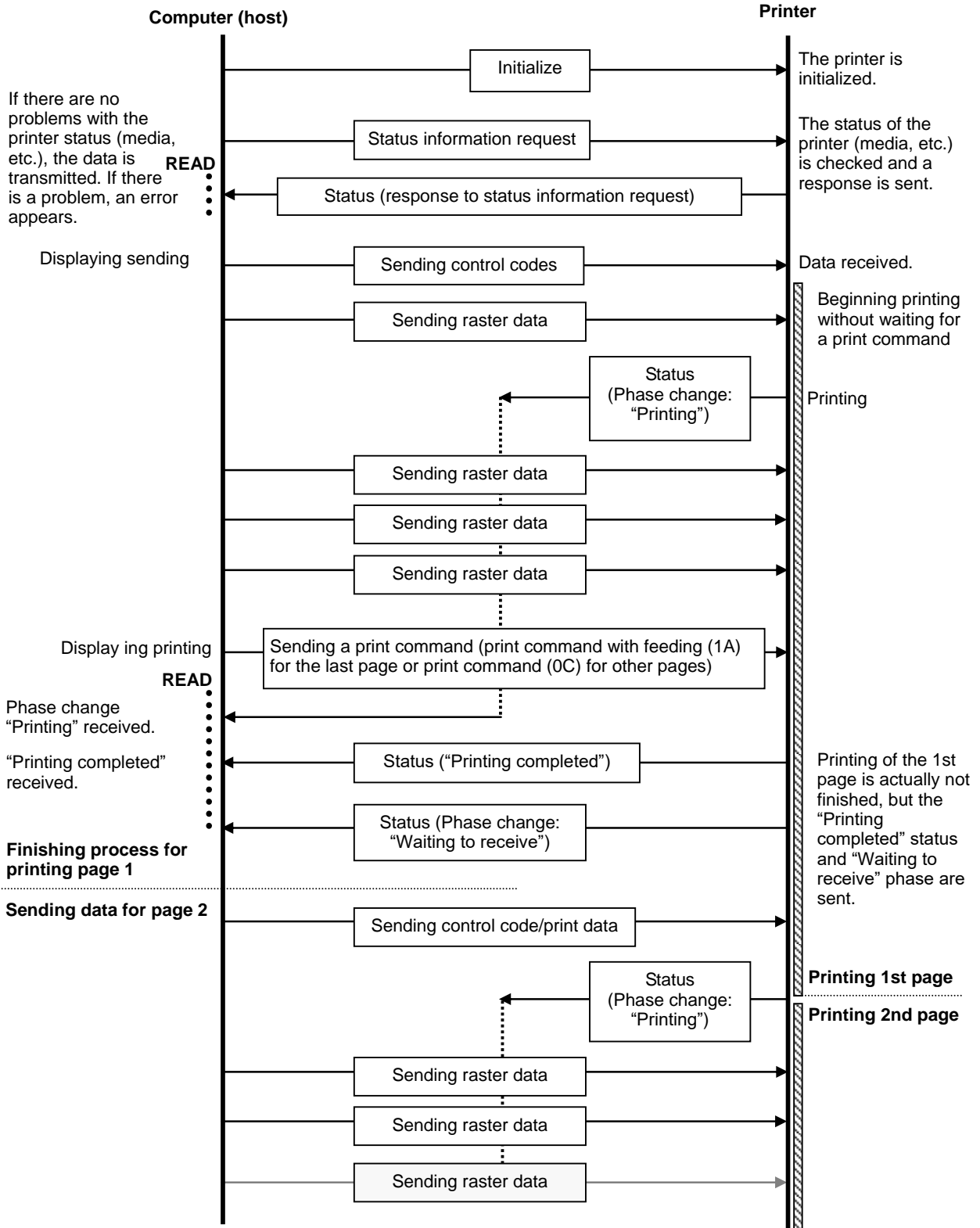

5.2 Error flow for USB connection (when feeding at the end of the page)

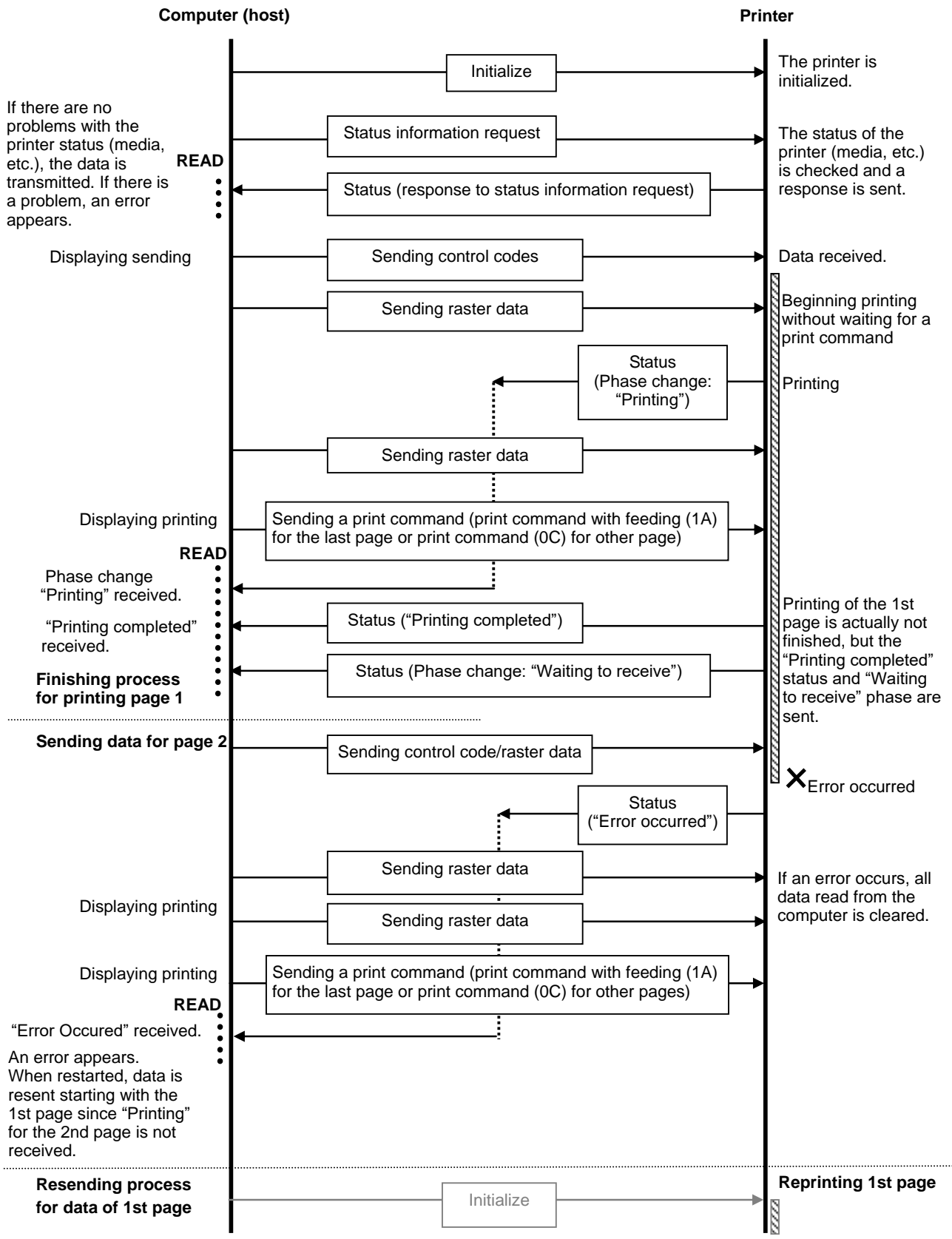

5.3 Error flow for USB connection (with a concurrent printing error such as end of tape)

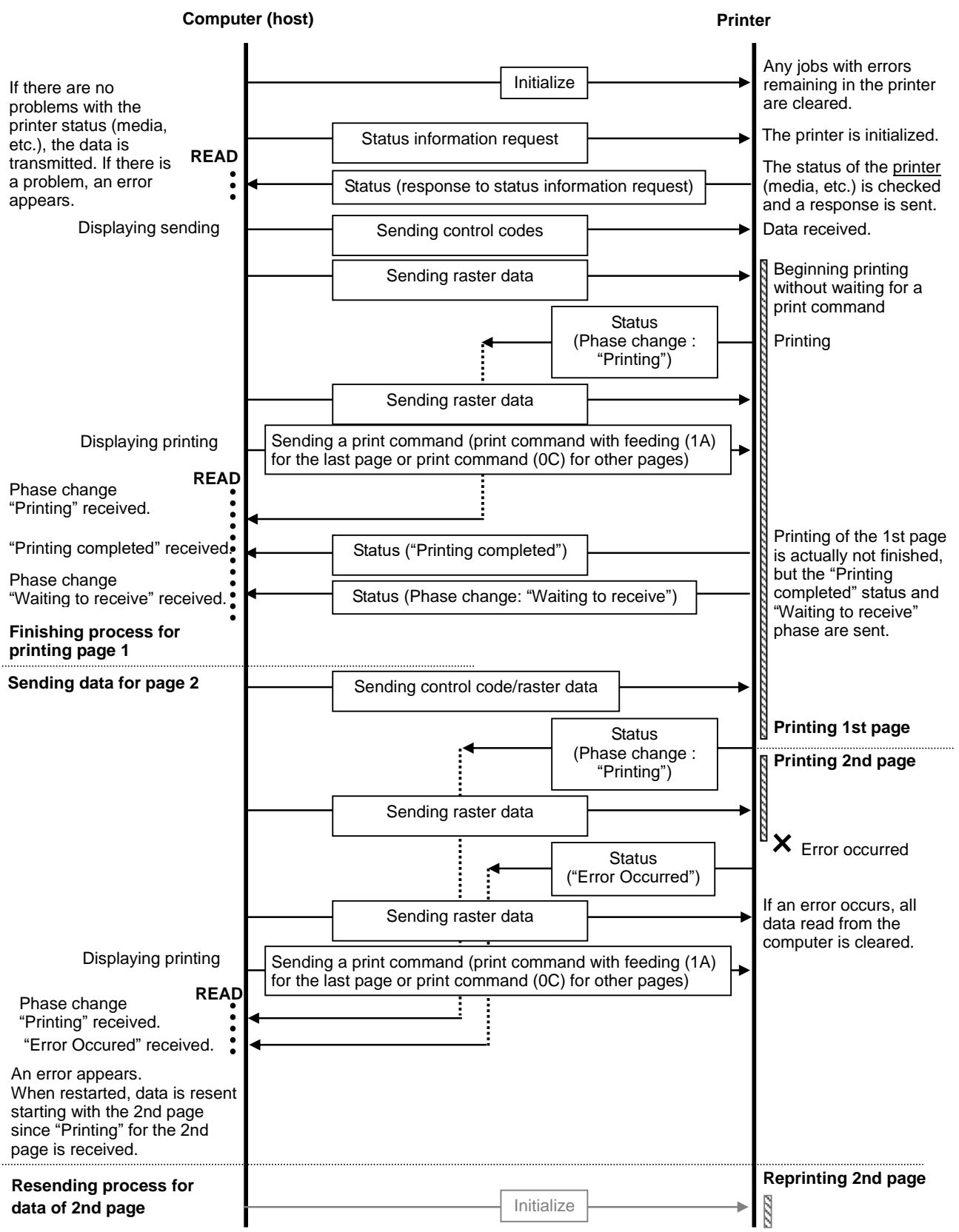

5.4 Cooling flow for USB connection

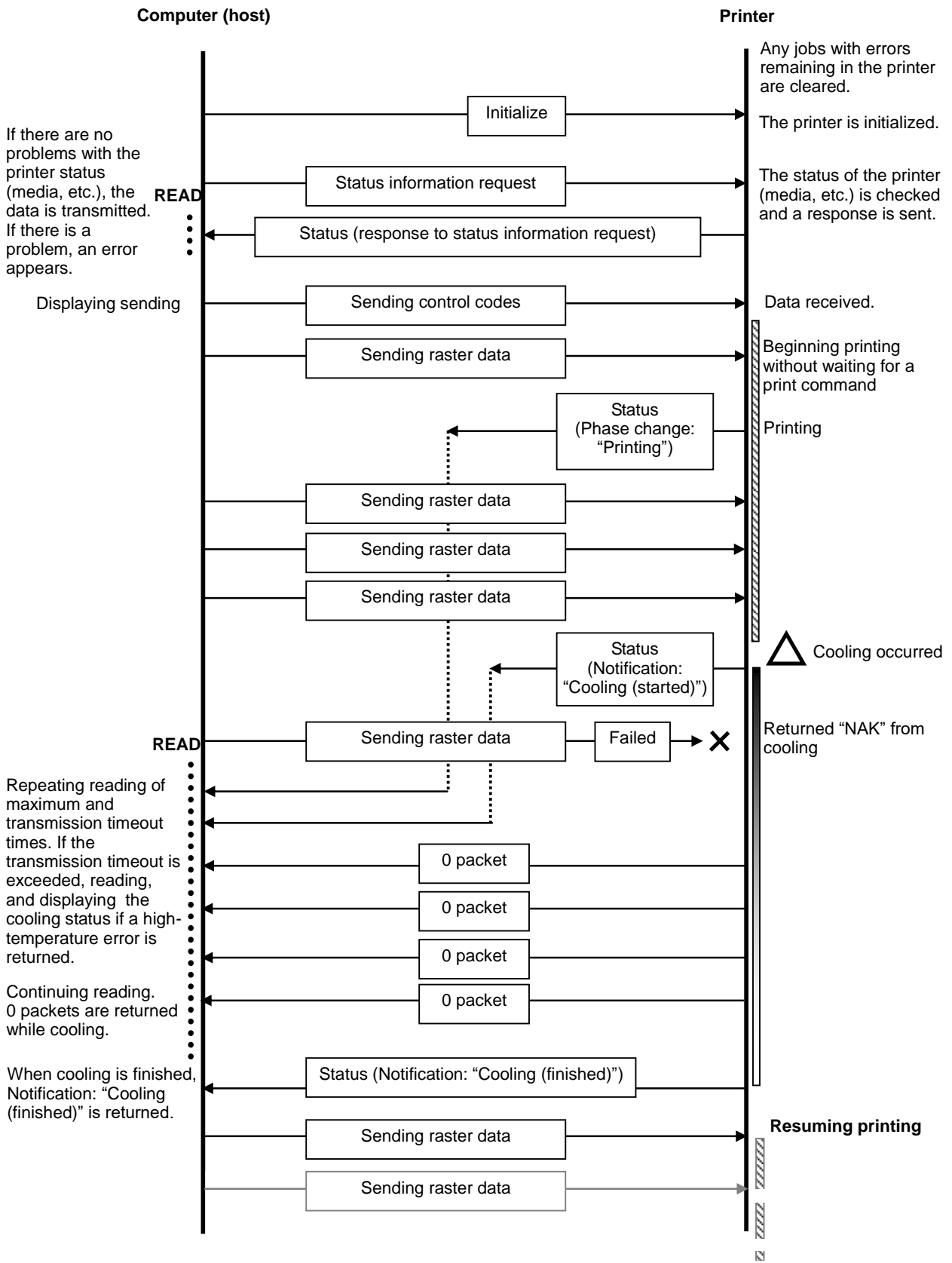

5.5 Flow for setting serial connection baud rate (QL-710W / QL-720NW Only)

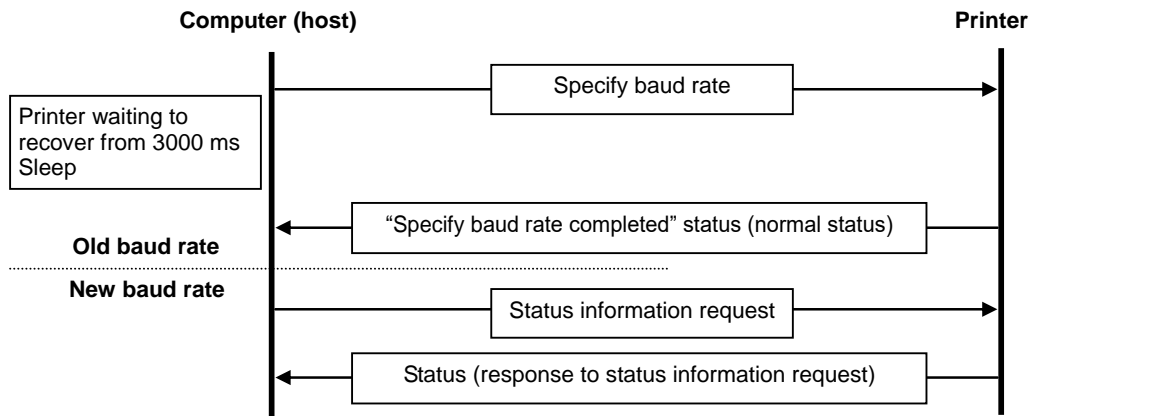

* The request/response at the new baud rate are simply to verify that communication is possible and may be omitted.

5.6 Normal flow for serial connection (QL-710W / QL-720NW Only)

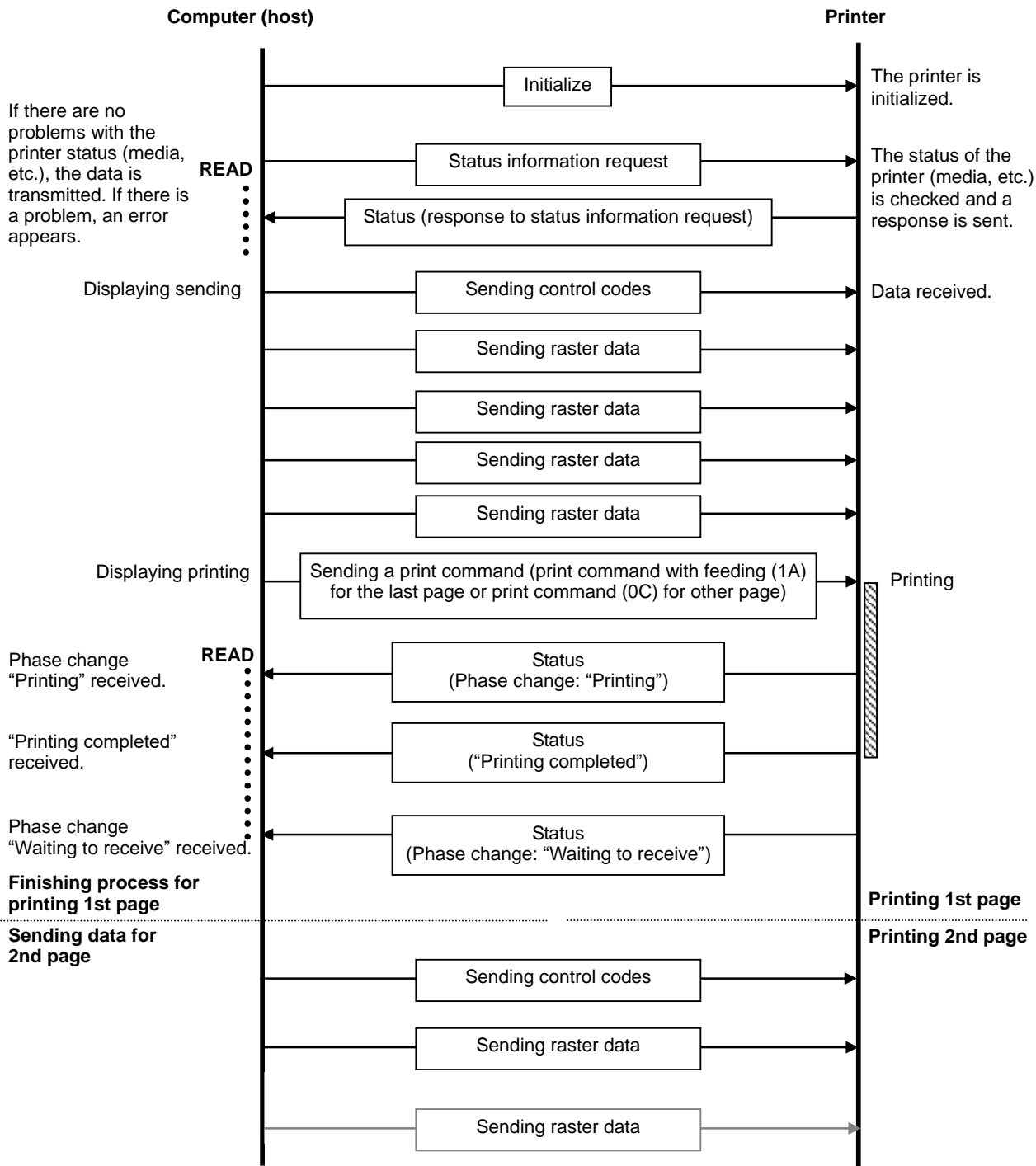

5.7 Error flow for serial connection (QL-710W / QL-720NW Only)

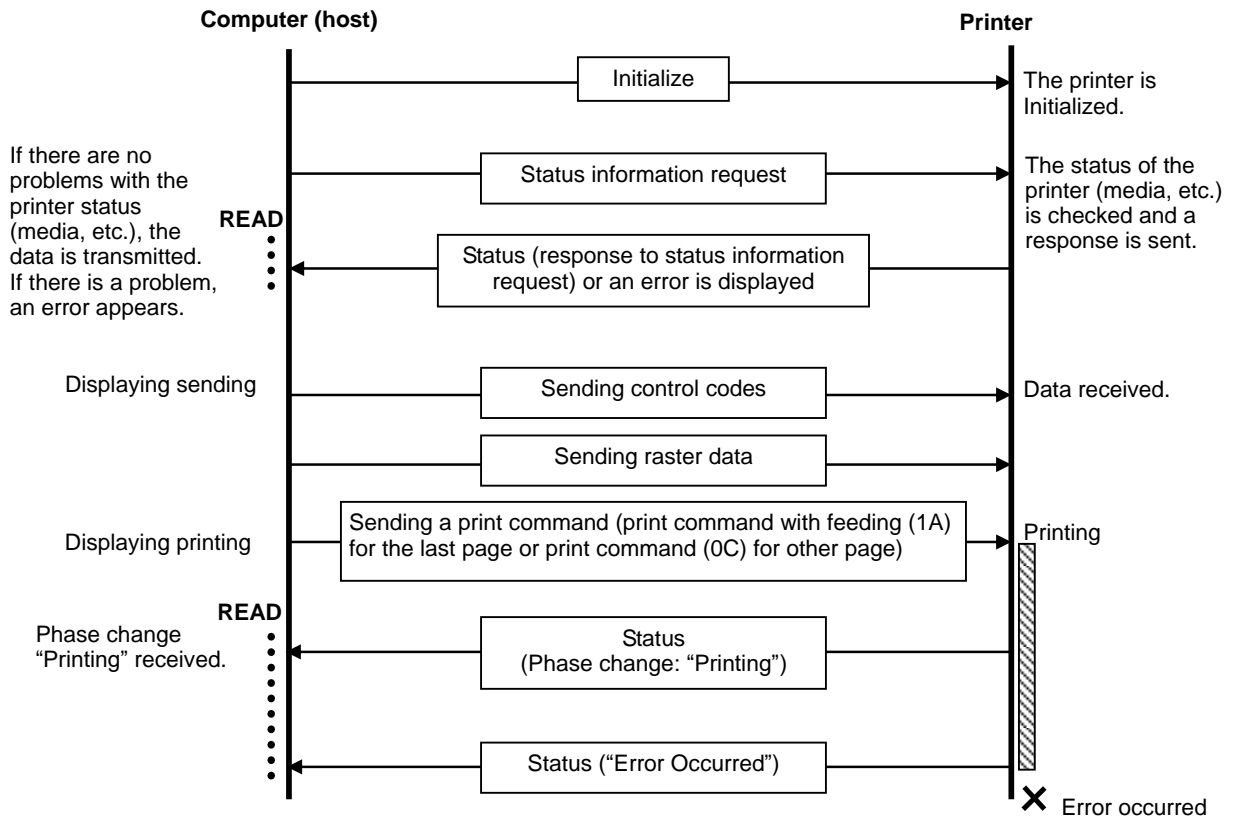

5.8 Cleaning flow for serial connection (QL-710W / QL-720NW Only)

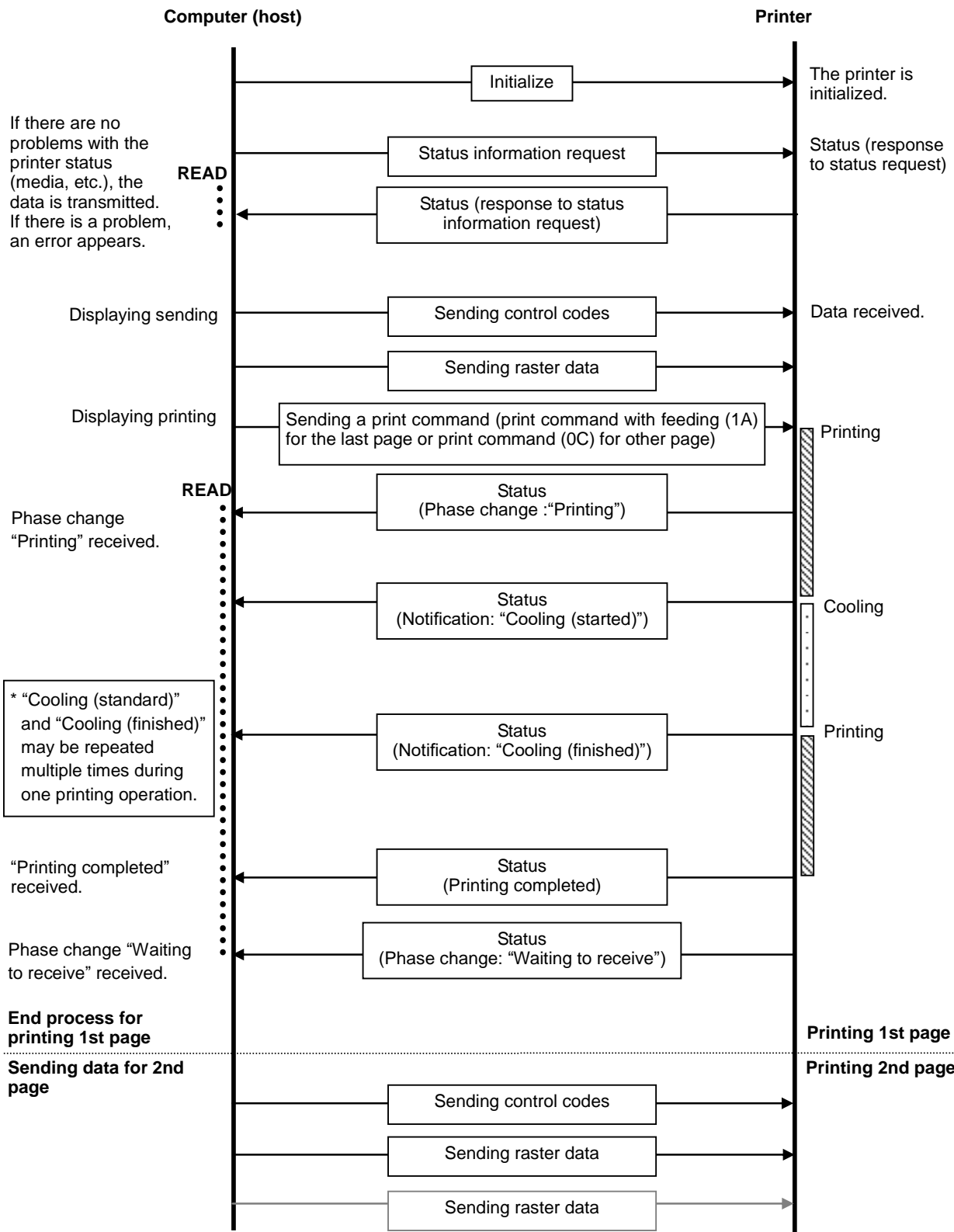

5.9 Normal Flow for Network (Standard TCP/IP port) Connection (QL-710W / QL-720NW Only)

*With a network connection, print data from the operating system's port monitor is simply sent as is.

When it prints 2 pages data

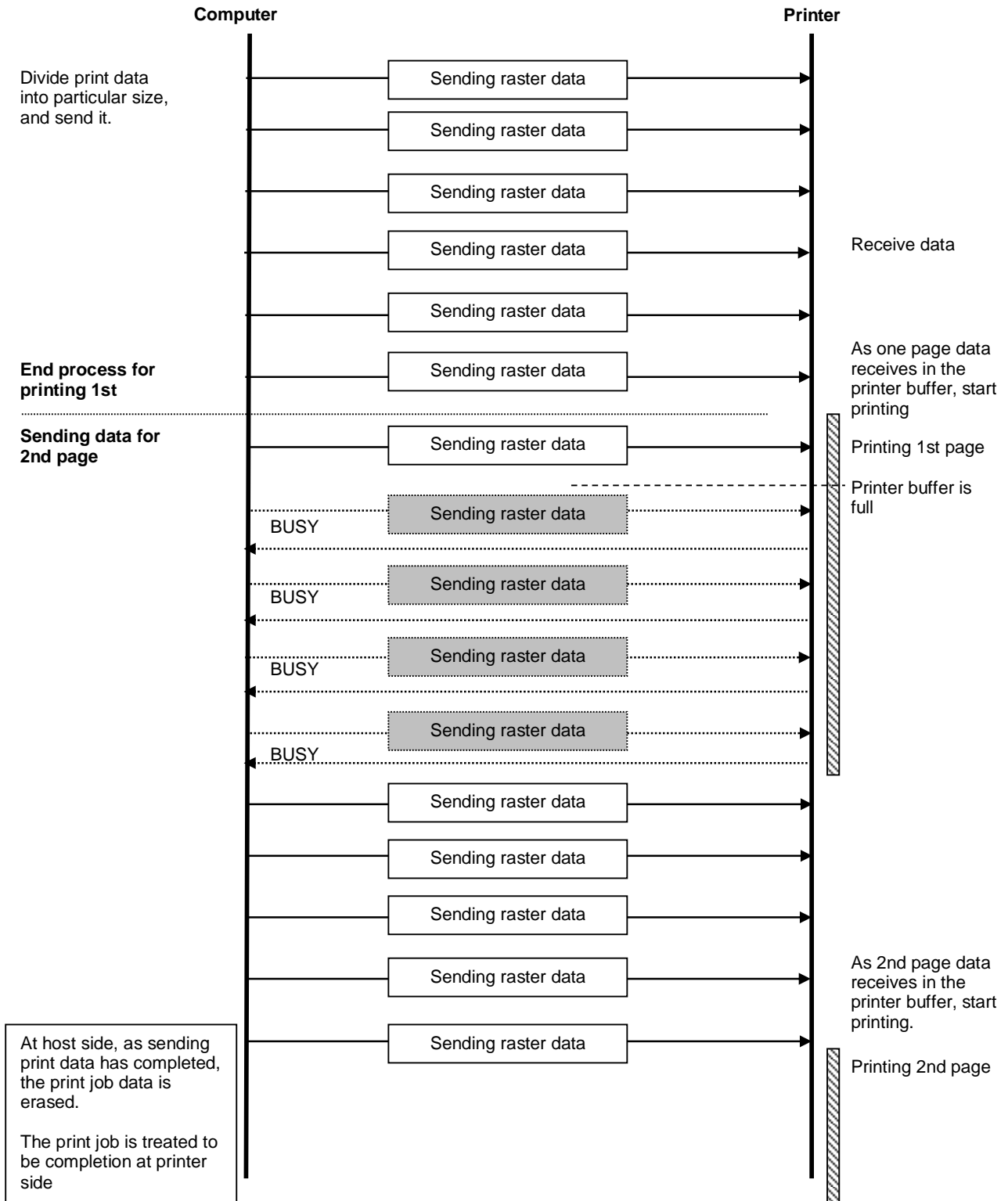

Appendix A: USB Specifications

USB specifications 1.1

Item	Description
Vendor ID	0x04F9
Product ID	QL-710W : 0x2043 QL-720NW : 0x2044 QL-600 : 0x20c0
Class	Printer Mass storage (QL-710W / QL-720NW Only)
Character string for manufacturer	Character string descriptor: 0x01 0x0409: "Brother"
Character string for serial number	Character string descriptor: 0x03 0x0409: "000000000001" Last twelve digits of the printer's serial number
Device speed	Full speed
Number of interfaces	1 (No alternate interfaces)
Power supply	Self-powered
End point 1	In bulk (Sends the status from the printer to the computer.) Maximum packet size: 64 bytes
End point 2	Out bulk (Sends print commands and data from the computer to the printer.) Maximum packet size: 64 bytes

Appendix B: Introducing the Brother Developer Center

Useful information for developers, such as applications, tools, SDKs as well as FAQs, are provided in the Brother Developer Center.

<http://www.brother.com/product/dev/index.htm>

brother