

Before you can use the MFC, you must set up the hardware and install the software. Please read this "Quick Setup Guide" for the correct setup procedure and installation instructions.

## Step 1

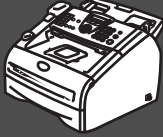

### Setting Up the MFC

## Step 2



### Installing the Drivers & Software





### Setup is Complete!

Keep this "Quick Setup Guide", User's Guide and supplied CD-ROM in a convenient place for quick and easy reference at all times.

<b>Warning</b>
Indicates warnings that must be observed to prevent possible personal injury and damage to the MFC.







<b>Improper Setup</b>
Alerts you to devices and operations that are not compatible with the MFC.

<b>Note</b>
Indicates notes and useful tips to remember when using the MFC.

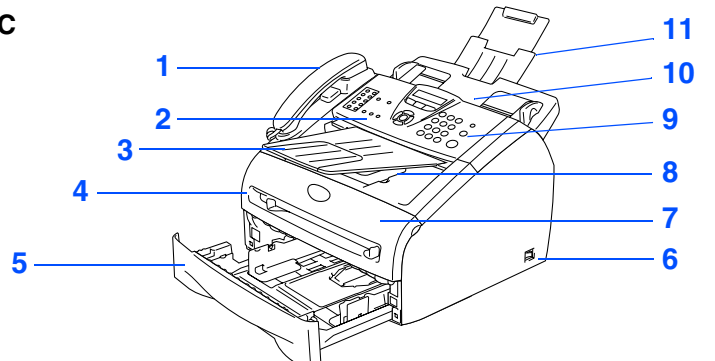
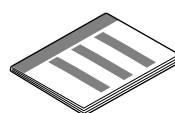

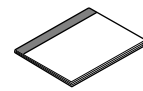
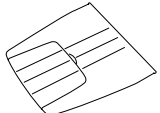
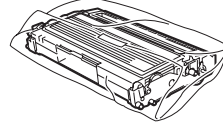
<b>User's Guide</b>
Indicates reference to the User's Guide.

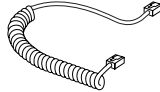
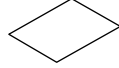
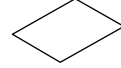
# Getting Started

## Carton Components

<p><b>MFC</b></p>  <p>1. Telephone Handset 2. Control Panel Cover 3. ADF Document Output Support 4. Manual Feed Slot 5. Paper Tray 6. Power Switch 7. Front Cover 8. Face-down Output Tray Support Flap with Extension 9. Control Panel 10. Automatic Document Feeder (ADF) 11. ADF Document Support</p>	 <p><b>Quick Setup Guide</b></p>	
	 <p><b>CD-ROMs For Windows® For Macintosh®</b></p>	
	 <p><b>User's Guide</b></p>	
 <p><b>ADF Document Output Support</b></p>	 <p><b>Drum Unit Assembly (including Starter Toner Cartridge)</b></p>	 <p><b>Telephone Line Cord</b></p>
 <p><b>Telephone Handset</b></p>	 <p><b>Curled Handset Cord</b></p>	
 <p><b>Test Sheet (USA only)</b></p>	 <p><b>Accessory Order Form (USA/Canada only)</b></p>	

Carton components may differ from one country to another.  
Save all packing materials and the carton.

 *The interface cable is not a standard accessory. Please purchase the appropriate interface cable for the interface you intend to use (Parallel or USB).*

■ **USB interface cable**

*Please make sure you use a USB 2.0 interface cable that is no longer than 6 feet (2.0 meters).  
When you use a USB cable, make sure you connect it to the USB port of your computer and not to a USB port on a keyboard or non-powered USB hub.  
Do NOT connect the interface cable at this time.  
Connecting the interface cable is done during the software installation process.*

■ **Parallel interface cable**

*Please make sure you use a Parallel interface cable that is no longer than 6 feet (2.0 meters).  
Use a shielded interface cable that is IEEE 1284-compliant.*

# Control Panel

MFC-7220

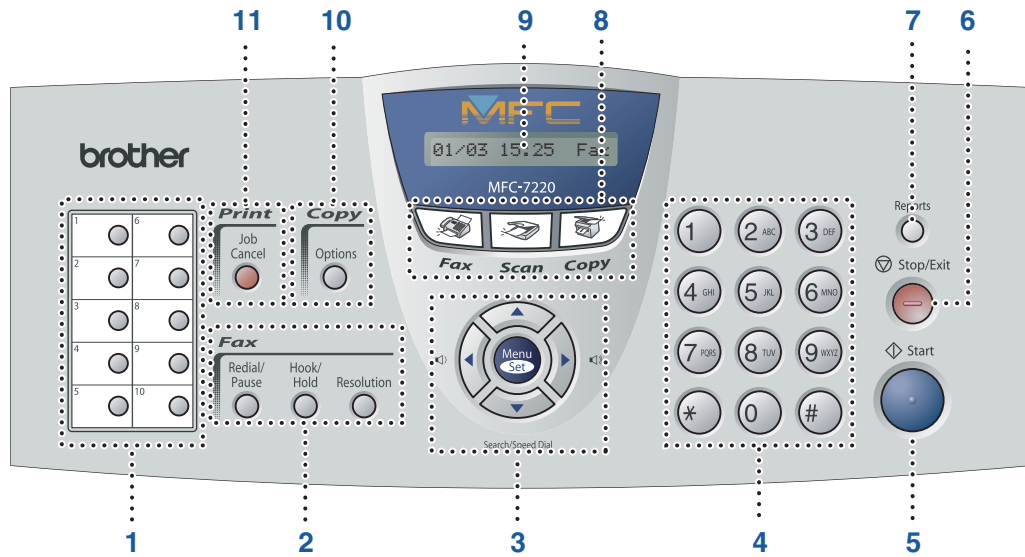

1. One Touch keys	2. Fax and telephone keys	3. Navigation keys
4. Dial Pad	5. Start key	6. Stop/Exit key
7. Reports key	8. Mode keys	9. Liquid Crystal Display(LCD)
10. Copy Options key	11. Job Cancel key	



For the details of the control panel, see "Control panel overview" in Chapter 1 of the User's Guide.

MFC-7225N

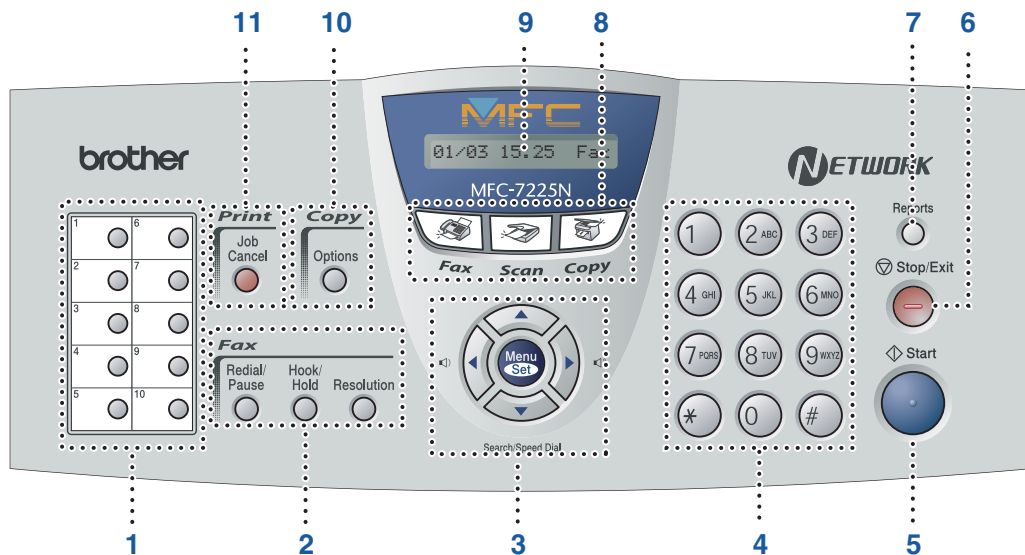

1. One Touch keys	2. Fax and telephone keys	3. Navigation keys
4. Dial Pad	5. Start key	6. Stop/Exit key
7. Reports key	8. Mode keys	9. Liquid Crystal Display(LCD)
10. Copy Options key	11. Job Cancel key	



For the details of the control panel, see "Control panel overview" in Chapter 1 of the User's Guide.

# Table of Contents

## Step 1 Setting Up the MFC

1. Attach the ADF Document Output Support .....	4
2. Install the Handset .....	4
3. Install the Drum Unit Assembly .....	5
4. Load Paper in the Paper Tray .....	6
5. Install the Power Cord and Phone Line .....	7
6. Set the Date and Time.....	8
7. Set your Station ID .....	9
8. Select a Receive Mode.....	10
9. Select Your Language (Canada only).....	11
10. Set the LCD Contrast .....	11
11. Send the Product Registration and Test Sheet (USA Only).....	11

## Step 2 Installing the Drivers & Software

Windows®	Supplied CD-ROM “MFL-Pro Suite” .....	12
	For USB Interface Cable Users	
	■ For Windows® 98/98SE/Me/2000 Professional/XP .....	14
	For Parallel Interface Cable Users	
	■ For Windows® 98/98SE/Me/2000 Professional/XP .....	17
	For Windows NT® Workstation Version 4.0 Users .....	20
	For Network Interface Cable Users (MFC-7225N and Optional NC-2200w only)	
	■ For Windows® 98/98SE/Me/NT/2000 Professional/XP .....	22
Macintosh®	For USB Interface Cable Users	
	■ For Mac OS® 9.1 to 9.2 .....	24
	■ For Mac OS® X 10.2.4 or greater.....	26
	For Network Interface Cable Users (MFC-7225N and Optional NC-2200w only)	
	■ For Mac OS® 9.1 to 9.2 .....	29
	■ For Mac OS® X 10.2.4 or greater.....	31

### ■ For Network Users

Installing the BRAdmin Professional Configuration Utility (Windows® Users Only) .....	34
Setting your IP Address, Subnet Mask and Gateway using BRAdmin Professional (Windows® Users Only).....	35

### ■ Options and Consumables

Options .....	36
Replacement Consumables.....	36

# Step 1

# Setting Up the MFC

## 1 Attach the ADF Document Output Support



Do NOT connect the interface cable. Connecting the interface cable is done during the software installation process.

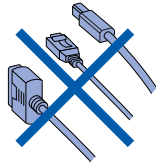

- 1 Pull out the ADF Document Output Support.

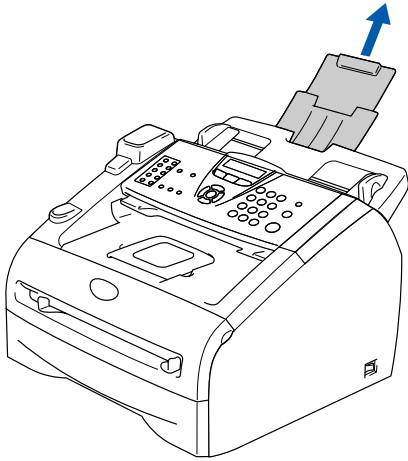

- 2 Open the control panel cover by lifting it toward the back.

Control Panel Cover

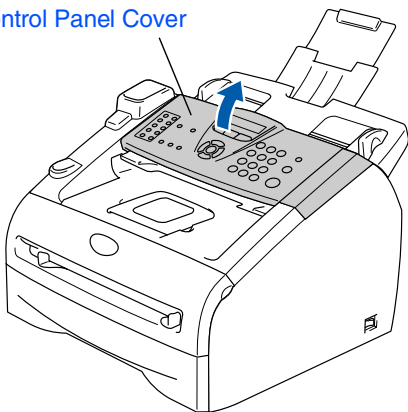

- 3 Attach the ADF Document Output Support.

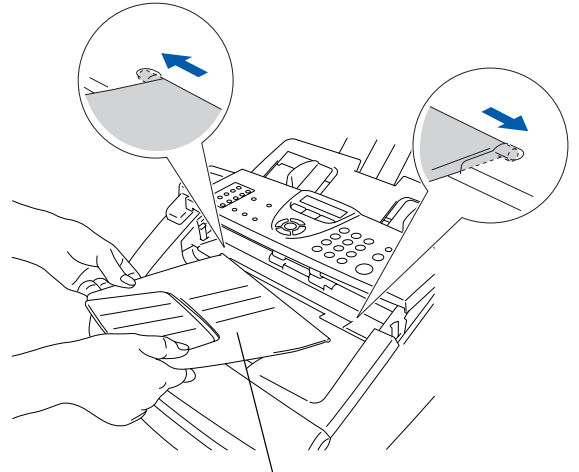

ADF Document Output Support

- 4 Close the control panel cover.

## 2 Install the Handset

- 1 Connect the curled handset cord to the MFC and the other end to the handset.

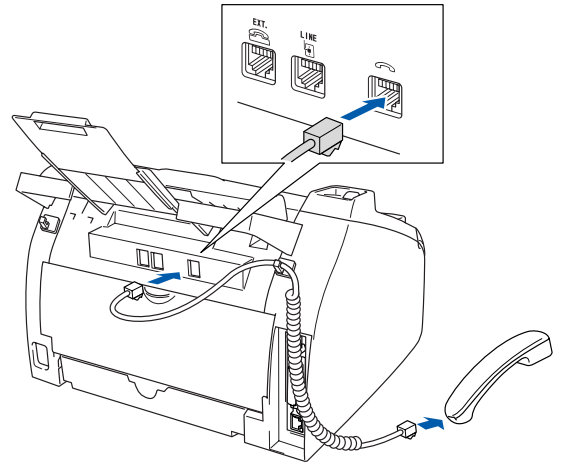

### 3

## Install the Drum Unit Assembly

- 1 Open the front cover of the MFC.

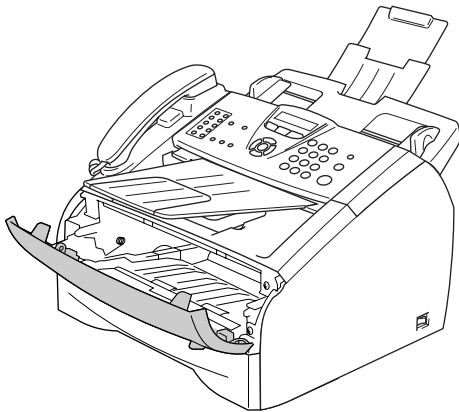
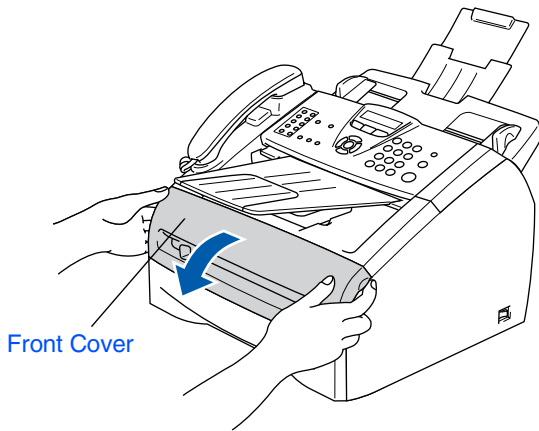

- 2 Unpack the drum unit assembly.

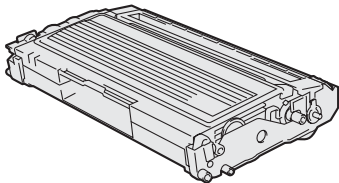

- 3 Gently rock it from side to side several times to distribute the toner evenly inside the assembly.

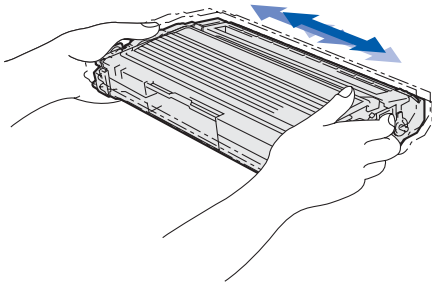

- 4 Put the drum unit assembly into the MFC.

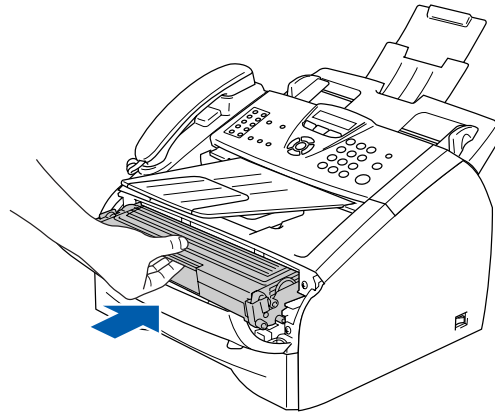

- 5 Close the front cover of the MFC.

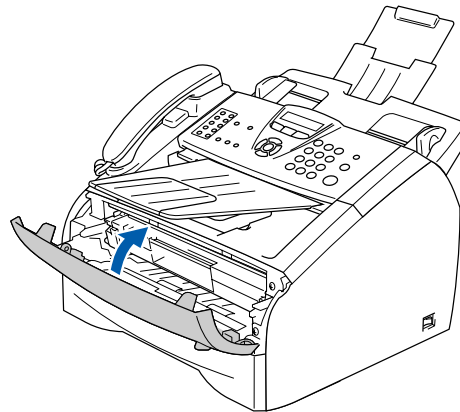

## 4 Load Paper in the Paper Tray

- 1 Pull the paper tray completely out of the MFC.

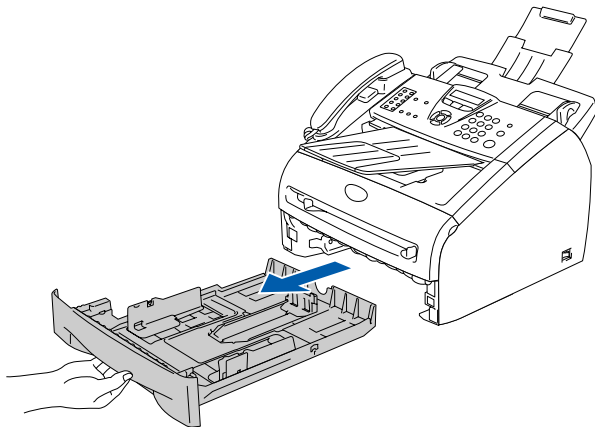

- 2 While pressing the paper guide release lever, slide the adjusters to fit the paper size. Check that the guides are firmly in the slots.

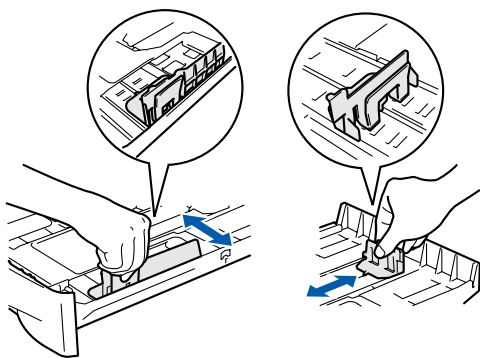

*For Legal size paper, press in the inside latches and pull out the back of the paper tray.*

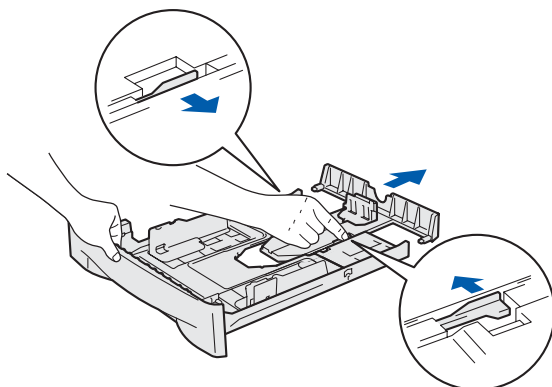

- 3 Fan the stack of paper well to avoid paper jams and misfeeds.

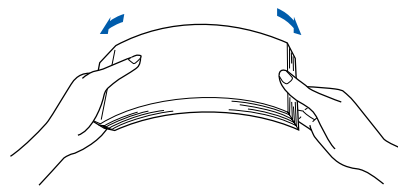

- 4 Put paper in the paper tray. Check that the paper is flat in the tray and below the maximum paper mark.

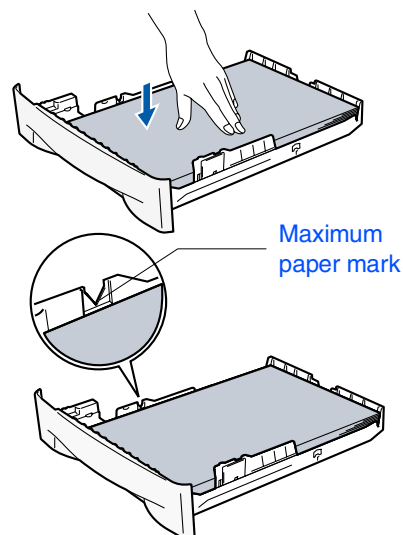

- 5 Put the paper tray firmly back into the MFC and unfold the output paper tray support flap before you use the MFC.

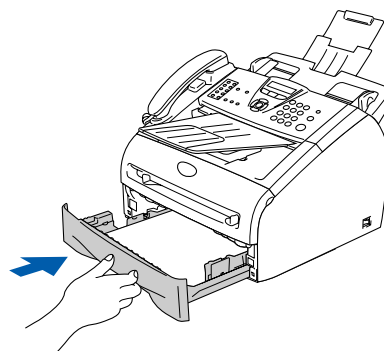

Output paper tray support flap

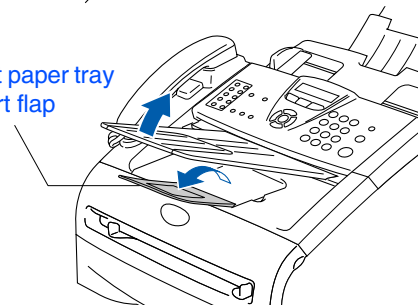

*For details on supported paper specifications, see "About paper" in Chapter 1 of the User's Guide.*



# 5

## Install the Power Cord and Phone Line



**Do not connect the Parallel or USB cable yet.**

- 1 Plug the AC power cord into an AC outlet. Turn the power switch on.



- 2 Connect one end of the telephone line cord to the jack on the MFC marked **LINE** and the other end to a modular wall jack.

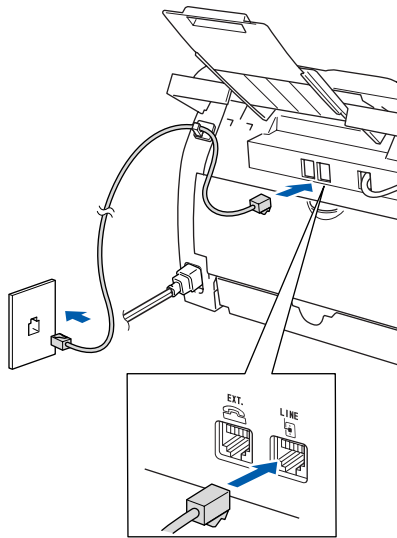

### **Warning**

- The MFC must be grounded using a 3-prong plug.
- Since the MFC is grounded through the power outlet, you can protect yourself from potentially hazardous electrical conditions on the telephone network by keeping the power cord connected to your MFC when you connect it to a telephone line. Similarly, you can protect yourself when you want to move your MFC by disconnecting the telephone line first and then the power cord.



If you are sharing one phone line with an external telephone, connect it as shown below.

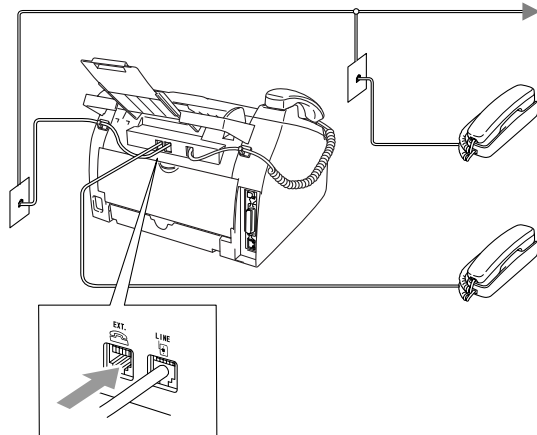

If you are sharing one phone line with an external telephone answering device, connect it as shown below.



Please set the receive mode to External TAD.

For more details, see "Connecting an external telephone answering device (TAD)" in the Appendix of the User's Guide.

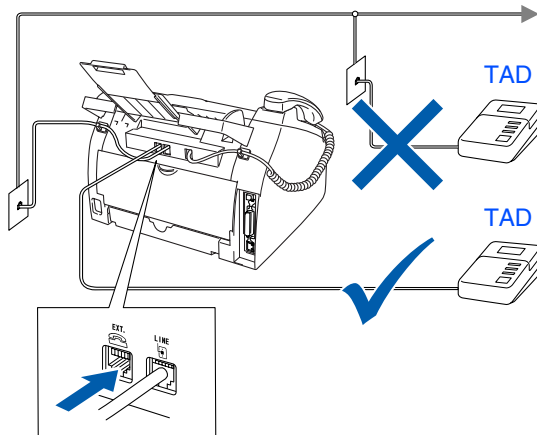

## 6 Set the Date and Time

The MFC displays the date and time, and prints it on every fax you send.

1 Press **Menu/Set**.

2 Press **0**.

3 Press **2**.

4 Enter the last two digits of the year on the dial pad, and then press **Menu/Set**.

Year: 2005

(e.g. Enter **0, 5** for 2005.)

5 Enter the two digits for the month on the dial pad, and then press **Menu/Set**.

Month: 03

(e.g. Enter **0, 3** for March)

6 Enter the two digits for the day on the dial pad, and then press **Menu/Set**.

Day: 01

(e.g. Enter **0, 1**.)

7 Enter the time in 24-hour format on the dial pad, and then press **Menu/Set**.

Time: 15:25

(e.g. Enter **1, 5, 2, 5** for 3:25 P.M.)

8 Press **Stop/Exit**.



*If you make a mistake, press **Stop/Exit** to start from Step 1.*

## 7 Set your Station ID

You should store your name and fax number to be printed on all fax pages that you send.

- 1 Press **Menu/Set**.
- 2 Press **0**.
- 3 Press **3**.
- 4 Enter your fax number (up to 20 digits) on the dial pad, and then press **Menu/Set**.

Fax: \_

- 5 Enter your telephone number (up to 20 digits) on the dial pad, and then press **Menu/Set**.  
(If your telephone number and fax number are the same, enter the same number again.)

Tel: \_

- 6 Use the dial pad to enter your name (up to 20 characters), and then press **Menu/Set**.

Name: \_

- 7 Press **Stop/Exit**.



- Refer to the following chart for entering your name.
- If you need to enter a character that is on the same key as the previous character, press  to move the cursor to the right.

Press key	One time	Two times	Three times	Four times
2	A	B	C	2
3	D	E	F	3
4	G	H	I	4
5	J	K	L	5
6	M	N	O	6
7	P	Q	R	S
8	T	U	V	8
9	W	X	Y	Z





For more details, see "Entering Text" in Appendix B of the User's Guide.

## 8 Select a Receive Mode

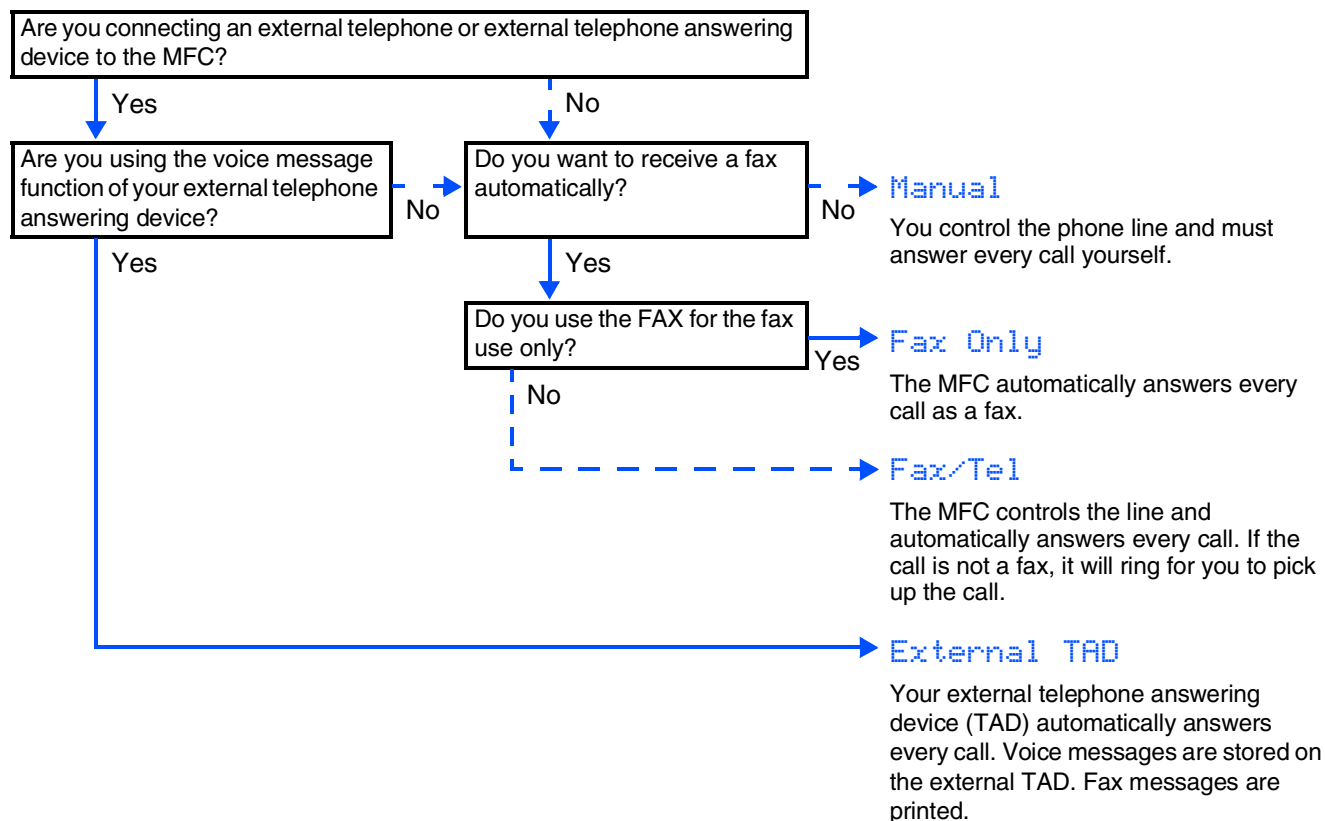
There are four possible receive modes: [Fax Only](#), [Fax/Tel](#), [Manual](#) and [External TAD](#).



Choose the [Receive Mode](#) which best suits your needs.



- 1 Press **Menu/Set**.
- 2 Press **0**.
- 3 Press **1**.
- 4 Press  or  to select the mode.  
Press **Menu/Set**.
- 5 Press **Stop/Exit**.



For more details, see "Setup Receive" in Chapter 4 of the User's Guide.

9

## Select Your Language (Canada only)



- 1 Press **Menu/Set**.
- 2 Press **0**.
- 3 Press **0**.
- 4 Select your language (**English** or **French**) by using  or , and then press **Menu/Set**.

Language: English

- 5 Press **Stop/Exit**.

## 10 Set the LCD Contrast

You can change the contrast to help the LCD look lighter or darker.

- 1 Press **Menu/Set**.
- 2 Press **1**.
- 3 Press **7**.
- 4 Press  or  to **Light** or **Dark**. Press **Menu/Set**.
- 5 Press **Stop/Exit**.

11

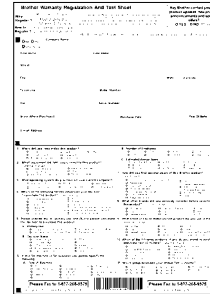

## Send the Product Registration and Test Sheet (USA Only)

- 1 Fill out the Product Registration and Test Sheet.

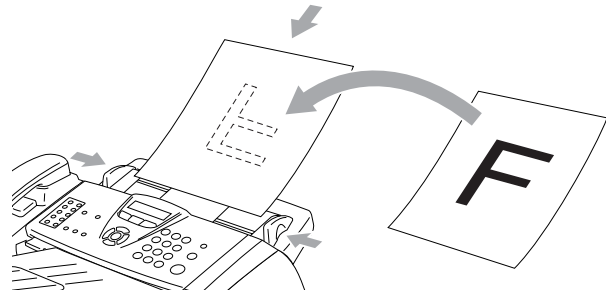

- 2 Place the sheet face down in the Automatic Document Feeder.



 Make sure  (Fax) is illuminated in Green.

- 3 Enter the toll-free fax number: 1-877-268-9575.

- 4 Press **Start**.

 You will receive a confirmation fax of your Product Registration.

 You can also register your product online using the On-Line Registration link from the installation CD-ROM or go to [www.brother.com/registration](http://www.brother.com/registration)

Go to Next page to install the drivers & software

## Supplied CD-ROM “MFL-Pro Suite”

The CD-ROM includes the following items:

### Windows®

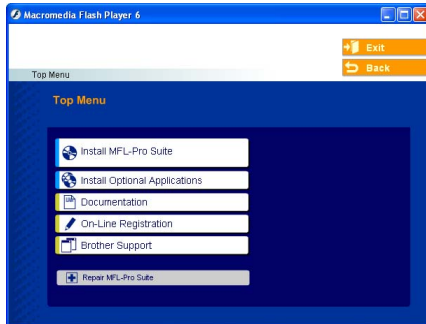

*MFL-Pro Suite includes Printer Driver, Scanner Driver, ScanSoft® PaperPort® 9.0SE, ScanSoft® OmniPage® and True Type® fonts. PaperPort® 9.0SE is a document management application for viewing scanned documents. ScanSoft® OmniPage®, which is integrated into PaperPort® 9.0SE, is an OCR application that converts an image into text and inserts it into your default word processor.*

### Macintosh®



#### **Install MFL-Pro Suite**

You can install the MFL-Pro Suite and multifunction drivers.



#### **Install Optional Applications**

You can install additional MFL-Pro Suite software utilities.



#### **Documentation\*<sup>1</sup>**

View the User's Guide and other documentation in PDF format (Viewer included).



#### **On-Line Registration**

You will be pointed to the Brother Product Registration Web page for quick registration of your MFC.



#### **Brother Support**

View contact information for Brother Customer Service and how to locate a Brother Authorized Service Center.



#### **Repair MFL-Pro Suite**

If you experience errors while installing the MFL-Pro Suite, you can use this function to automatically repair and re-install the software.



#### **Start Here OS 9.1-9.2**

You can install the printer driver, scanner driver and Presto!® PageManager® for Mac OS® 9.1 - 9.2.



#### **Start Here OSX**

You can install the printer driver, scanner driver, remote setup program and Presto!® PageManager® for Mac OS® 10.2.4 or greater.



#### **Readme.html**

You can get important information and troubleshooting tips.



#### **Documentation\*<sup>1</sup>**

View the User's Guide and other documentation in PDF format.



#### **Brother Solutions Center**

You can access the Brother Solutions Center, a Web site offering information about your Brother product including FAQs, User's Guides, Driver updates and Tips for using your MFC.



#### **On-Line Registration**

You will be pointed to the Brother Product Registration Web Page for quick registration of your MFC.

\*<sup>1</sup> The User's Guide on the CD-ROM includes the Software and Network User's Guide for features available when connected to a computer (e.g. Printing and scanning).

Follow the instructions on this page for your operating system and interface cable.  
 For the latest drivers and to find the best solution for your problem or question, access the Brother Solutions Center directly from the driver or go to <http://solutions.brother.com>

Setting Up  
the MFC

Windows®



**USB Interface Cable Users** ..... Go to page 14  
 (For Windows® 98/98SE/Me/2000 Professional/XP)

Windows®  
USB



**Parallel Interface Cable Users** ..... Go to page 17  
 (For Windows® 98/98SE/Me/2000 Professional/XP)

Windows®  
Parallel



**Windows NT® Workstation Version 4.0 Users** ..... Go to page 20  
 (For Parallel Interface Cable Users)

Windows  
NT® 4.0  
Parallel



**Network Interface Cable Users**..... Go to page 22  
 (MFC-7225N and Optional NC-2200w only)

Windows®  
Network

Macintosh®



**USB Interface Cable Users**  
 ■ For Mac OS® 9.1 to 9.2 ..... Go to page 24  
 ■ For Mac OS® X 10.2.4 or greater ..... Go to page 26

Macintosh®  
USB



**Network Interface Cable Users (MFC-7225N and Optional NC-2200w only)**  
 ■ For Mac OS® 9.1 to 9.2 ..... Go to page 29  
 ■ For Mac OS® X 10.2.4 or greater..... Go to page 31

Macintosh®  
Network

**For Network Users** ..... Go to page 34

For  
Network Users

# Step 2

# Installing the Drivers & Software



## For USB Interface Cable Users

(For Windows® 98/98SE/Me/2000 Professional/XP)

**Make sure that you have completed the instructions from Step 1 “Setting Up the MFC” on pages 4 - 11.**



*Please close any applications running before installing the MFL-Pro Suite.*

- 1 Turn off and unplug the MFC from the AC outlet and disconnect it from your computer, if you already connected an interface cable.

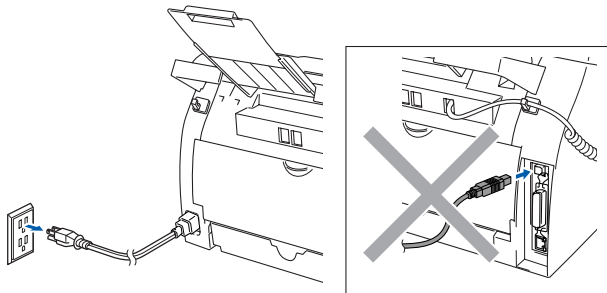

- 2 Turn on your computer. (For Windows® 2000 Professional/XP, you must be logged on with Administrator rights.)
- 3 Insert the supplied CD-ROM for Windows® into your CD-ROM drive. If the model name screen appears, select your MFC. If the language screen appears, select your language.



- 4 The CD-ROM main menu will appear. Click **Install MFL-Pro Suite**.

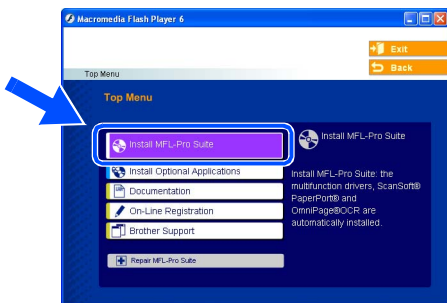

*If this window does not appear, use Windows® Explorer to run the **setup.exe** program from the root directory of the Brother CD-ROM.*

- 5 After reading and accepting the ScanSoft® PaperPort® 9.0SE License Agreement, click **Yes**.

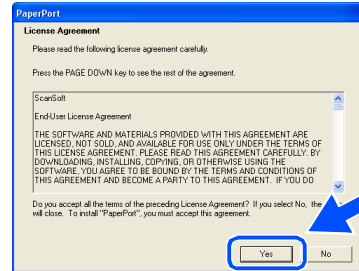

- 6 The installation of PaperPort® 9.0SE will automatically start and is followed by the installation of MFL-Pro Suite.

- 7 When the Brother MFL-Pro Suite Software License Agreement window appears, read the agreement, then click **Yes** if you agree to its terms.

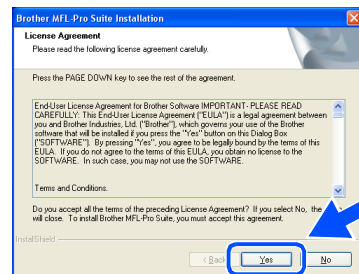

- 8 Select **Local Connection**, and then click **Next**. The installation will continue.

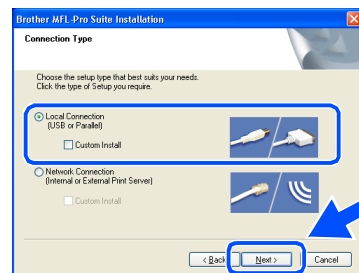

(MFC-7225N only)

*If you want to install the PS driver (Brother's BR-Script Driver), select **Custom Install** and then follow the on-screen instructions. When the **Select Components** screen appears, check **PS Printer Driver**, and then continue following the on-screen instructions.*



- 9 When this screen appears, connect the USB interface cable to your PC, and then connect it to the MFC.

(For Windows® XP)

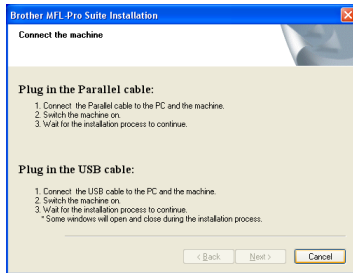

(For Windows® 98/98SE/Me/2000)

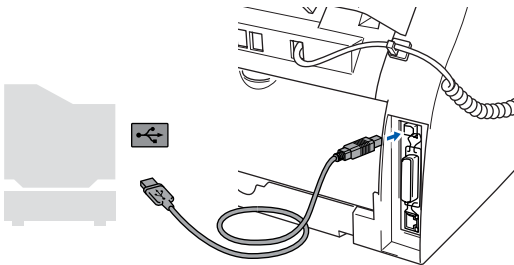
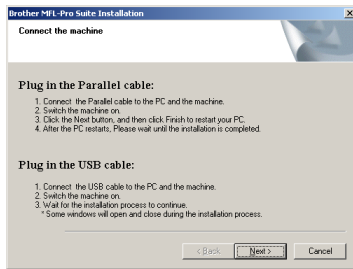

Brother recommends that you connect the MFC directly to your computer.



**DO NOT** connect the MFC to a USB port on a keyboard or a non-powered USB hub.

- 10 Plug in the power cord and turn on the MFC.

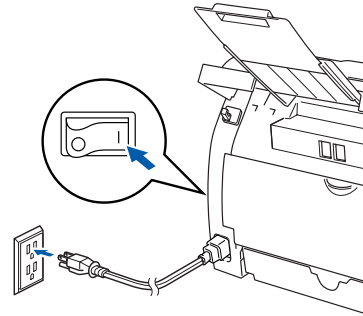

It will take a few seconds for the installation screen to appear.

The installation of the Brother drivers will automatically start. The screens appear one after another. Please wait, it will take a few seconds for all the screens to appear.



**DO NOT** try to cancel any of the screens during this installation.

- 11 When the On-Line Registration screen is displayed, make your selection and follow the on-screen instructions.

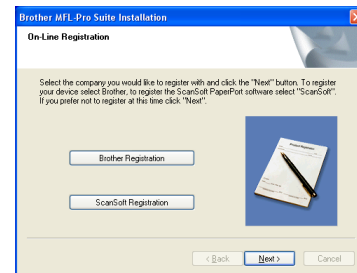

Continued ...



## For USB Interface Cable Users

(For Windows® 98/98SE/Me/2000 Professional/XP)

- 12 Click **Finish** to restart your computer.  
(After restarting the computer, for Windows® 2000 Professional/XP, you must be logged on with Administrator rights.)

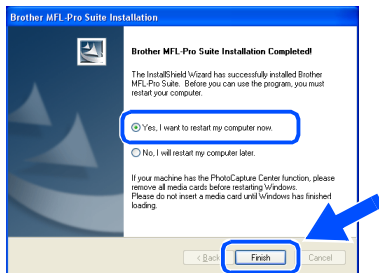

*If the installation is unsuccessful, try installing again using **Repair MFL-Pro Suite** from the CD-ROM main menu. Select **Repair MFL-Pro Suite** and follow the instructions on the screen.*

- OK!** The MFL-Pro Suite, Brother Printer Driver and Scanner driver have been installed and the installation is now complete.

## For Parallel Interface Cable Users (For Windows® 98/98SE/Me/2000 Professional/XP)

Make sure that you have completed the instructions from Step 1 “Setting Up the MFC” on pages 4 - 11.

 Please close any applications running before installing the MFL-Pro Suite.

- 1 Turn off and unplug the MFC from the AC outlet and disconnect it from your computer, if you already connected an interface cable.

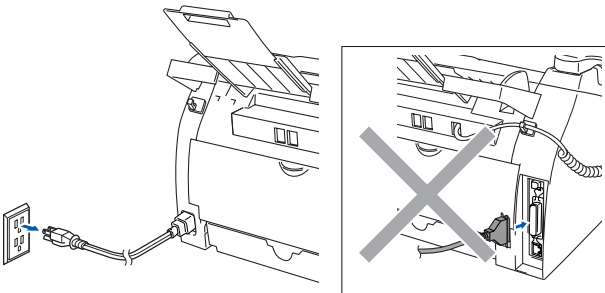

- 2 Turn on your computer. (For Windows® 2000 Professional/XP, you must be logged on with Administrator rights.)
- 3 Insert the supplied CD-ROM for Windows® into your CD-ROM drive. If the model name screen appears, select your MFC. If the language screen appears, select your language.



- 4 The CD-ROM main menu will appear. Click **Install MFL-Pro Suite**.

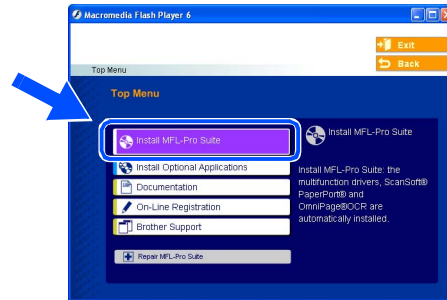

 If this window does not appear, use Windows® Explorer to run the **setup.exe** program from the root directory of the Brother CD-ROM.

- 5 After reading and accepting the ScanSoft® PaperPort® 9.0SE License Agreement, click **Yes**.

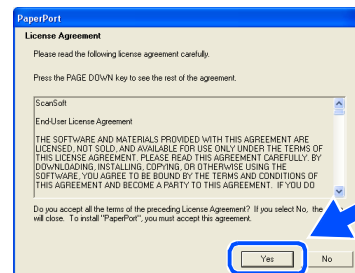

- 6 The installation of PaperPort® 9.0SE will automatically start and is followed by the installation of MFL-Pro Suite.

Continued ... 

# Step 2

# Installing the Drivers & Software

## For Parallel Interface Cable Users (For Windows® 98/98SE/Me/2000 Professional/XP)

- 7 When the Brother MFL-Pro Suite Software License Agreement window appears, read the agreement, then click **Yes** if you agree to its terms.

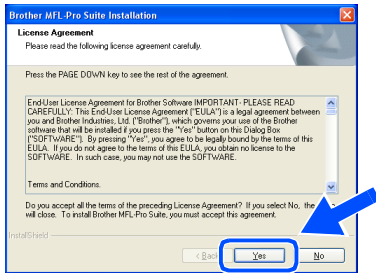

- 8 Select **Local Connection**, and then click **Next**. The installation will continue.

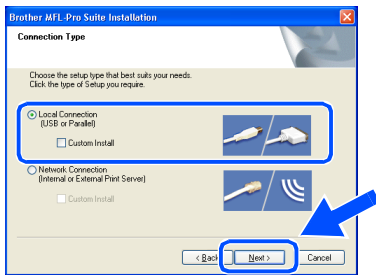

(MFC-7225N only)

If you want to install the PS driver (Brother's BR-Script Driver), select **Custom Install** and then follow the on-screen instructions. When the **Select Components** screen appears, check **PS Printer Driver**, and then continue following the on-screen instructions.

- 9 When this screen appears, connect the parallel interface cable to your PC, and then connect it to the MFC.

(For Windows® XP)

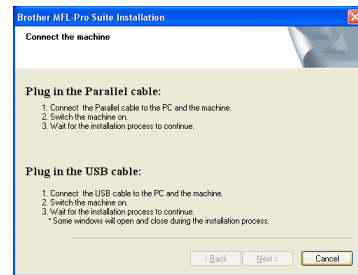

(For Windows® 98/98SE/Me/2000)

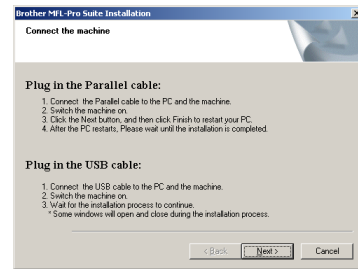

**DO NOT plug in the power cord before connecting the parallel interface cable. It may cause damage to your MFC.**

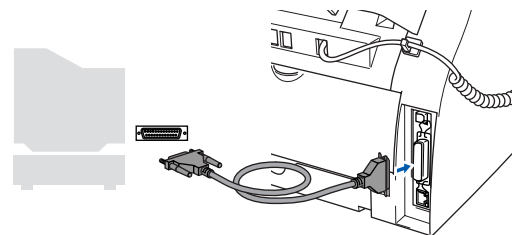

Brother recommends that you connect the MFC directly to your computer.

- 10 Plug in the power cord and turn on the MFC.

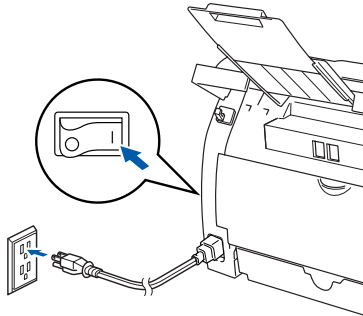

- 11 For Windows® 98/98SE/Me/2000 Professional users, click **Next**.

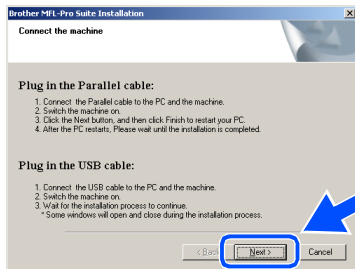

For Windows® XP users, wait for a while since the installation of the Brother drivers will automatically start. The screens appear one after another.



**DO NOT** try to cancel any of the screens during this installation.

- 12 When the On-Line Registration screen is displayed, make your selection and follow the on-screen instructions.

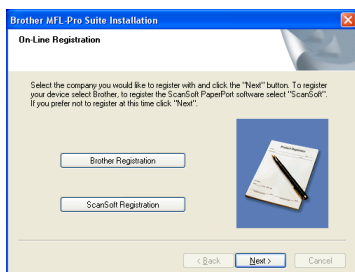

- 13 When the following screen appears, click **Finish** and wait as the PC restarts Windows® and continues the installation.

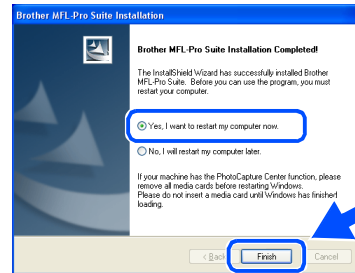

- 14 After the computer restarts, the installation of the Brother drivers will automatically start. Follow the instructions on the screen. (For Windows® 2000 Professional/XP, you must be logged on with Administrator rights.)

- 15 For Windows® 2000 Professional users, if the **Digital Signature Not Found** dialog boxes appear, click **Yes** to install the drivers.

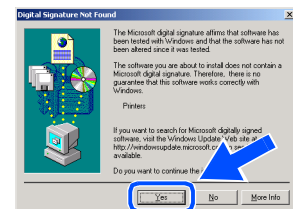
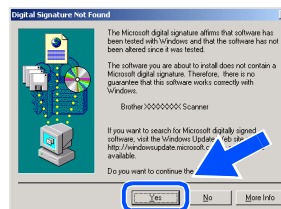

If the installation is unsuccessful, try installing again using **Repair MFL-Pro Suite** from the CD-ROM main menu.

Select **Repair MFL-Pro Suite** and follow the instructions on the screen.

- OK!** The MFL-Pro Suite, Printer driver and Scanner driver have been installed and the installation is now complete.

## For Windows NT® Workstation Version 4.0 Users

Make sure that you have completed the instructions from Step 1 “Setting Up the MFC” on pages 4 - 11.

 Please close any applications running before installing the MFL-Pro Suite.

- 1 Turn off and unplug the MFC from the AC outlet.
- 2 Turn on your computer. You must be logged on with Administrator rights.

 **DO NOT plug in the power cord before connecting the parallel interface cable. It may cause damage to your MFC.**

- 3 Connect the parallel interface cable to your computer, and then connect it to the MFC.

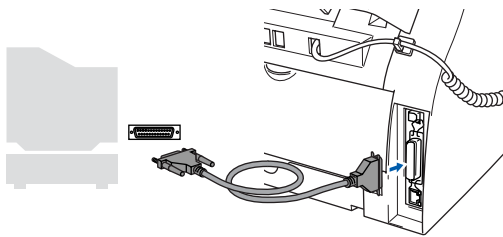

 Brother recommends that you connect the MFC directly to your computer.

- 4 Plug in the power cord and turn on the MFC.

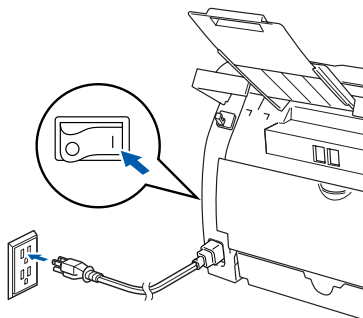

- 5 Insert the Supplied CD-ROM for Windows® into your CD-ROM drive. If the model name screen appears, select your MFC. If the language screen appears, select your language.



- 6 The CD-ROM main menu will appear. Click **Install MFL-Pro Suite**.

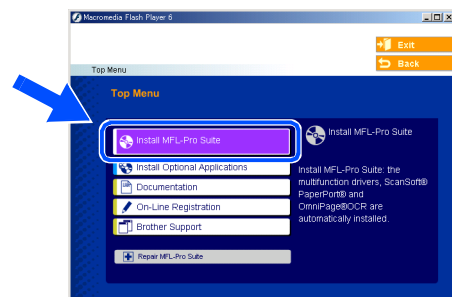

 If this window does not appear, use Windows® Explorer to run the **setup.exe** program from the root directory of the Brother CD-ROM.

- 7 After reading and accepting the ScanSoft® PaperPort® 9.0SE License Agreement, click **Yes**.



- 8 The installation of PaperPort® 9.0SE will automatically start and is followed by the installation of MFL-Pro Suite.
- 9 When the Brother MFL-Pro Suite Software License Agreement window appears, read the agreement, then click **Yes** if you agree to its terms.

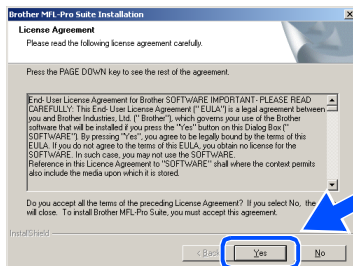

- 10 Select **Local Connection**, and then click **Next**. The installation will continue.

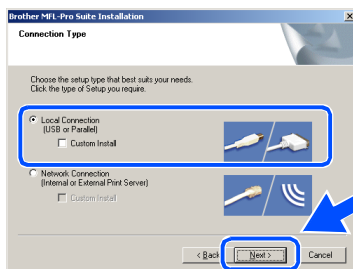

(MFC-7225N only)

If you want to install the PS driver (Brother's BR-Script Driver), select **Custom Install** and then follow the on-screen instructions. When the **Select Components** screen appears, check **PS Printer Driver**, and then continue following the on-screen instructions.

- 11 When the On-Line Registration screen is displayed, make your selection and follow the on-screen instructions.

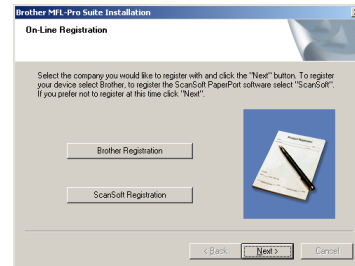

- 12 When the following screen appears, click **Finish** and wait as the PC restarts Windows® and continues the installation. (You must be logged on with Administrator rights.)

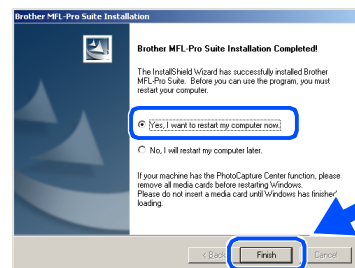

If the installation is unsuccessful, try installing again using **Repair MFL-Pro Suite** from the CD-ROM main menu.

Select **Repair MFL-Pro Suite** and follow the instructions on the screen.

- OK!** The MFL-Pro Suite, Printer driver and Scanner driver have been installed and the installation is now complete.

# Step 2

# Installing the Drivers & Software



For Network Interface Cable Users (MFC-7225N and Optional NC-2200w only)  
(For Windows® 98/98SE/Me/NT/2000 Professional/XP)

Make sure that you have completed the instructions from Step 1 “Setting Up the MFC” on pages 4 - 11.

- 1 Turn off and unplug the MFC from the AC outlet.
- 2 Connect the network cable to the MFC, and then connect it to a free port on your hub.

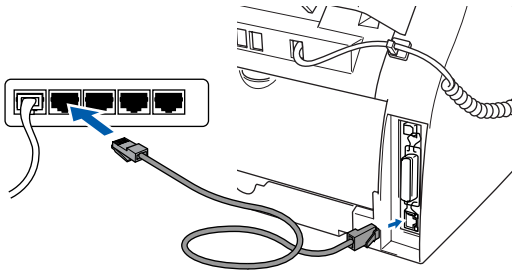

 If you are using the optional NC-2200w External Wireless Print/Scan Server, follow installation steps 1 to 3 in the NC-2200w Quick Setup Guide first. Then go to step 6.

- 3 Plug in the power cord and turn on the MFC.

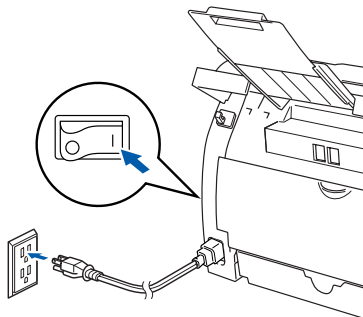

- 4 Turn on your computer.  
(For Windows® 2000 Professional/XP/Windows NT® 4.0, you must be logged on with Administrator rights.)  
Close any applications running before installing the MFL-Pro Suite.

 Before installation, if you are using Personal Firewall software, disable it. Once you are sure that you can print after the installation, re-start your Personal Firewall software.

- 5 Insert the supplied CD-ROM for Windows® into your CD-ROM drive. If the model name screen appears, select your MFC. If the language screen appears, select your language.



- 6 The CD-ROM main menu will appear. Click **Install MFL-Pro Suite**.

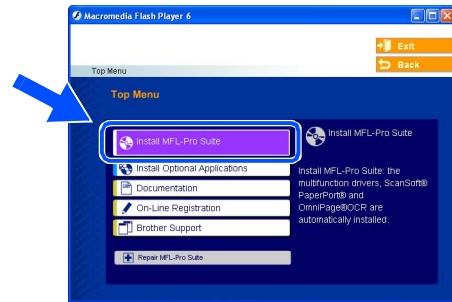

 If this window does not appear, use Windows® Explorer to run the **setup.exe** program from the root directory of the Brother CD-ROM.

- 7 After reading and accepting the ScanSoft® PaperPort® 9.0SE License Agreement, click **Yes**.

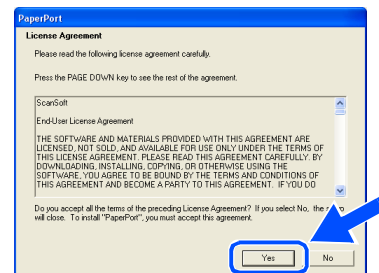

- 8 The installation of PaperPort® 9.0SE will automatically start and is followed by the installation of MFL-Pro Suite.

- 9 When the Brother MFL-Pro Suite Software License Agreement window appears, read the agreement, then click **Yes** if you agree to its terms.

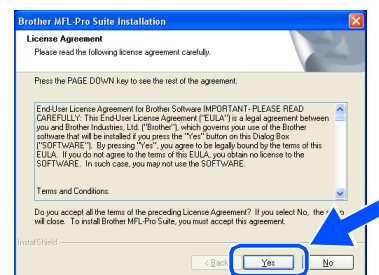



- 10 Select **Network Connection** and then click **Next**.

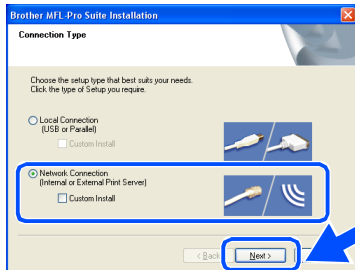

(MFC-7225N only)

If you want to install the PS driver (Brother's BR-Script Driver), select **Custom Install** and then follow the on-screen instructions. When the **Select Components** screen appears, check **PS Printer Driver**, and then continue following the on-screen instructions.

- 11 The installation of the Brother drivers will automatically start. The installation screens appear one after another. Please wait, it will take a few seconds for all the screens to appear.



**DO NOT** try to cancel any of the screens during this installation.

- 12 If the MFC is configured for your network, select your MFC from the list and then click **Next**.

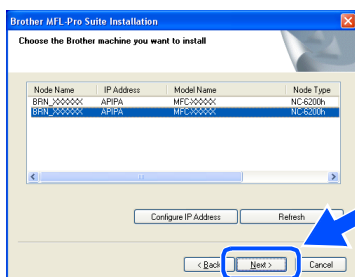

This window will not appear if there is only one of this Brother model connected on the network, it will be selected automatically.

- 13 If the MFC is not yet configured for use on your network, the following screen appears.



Click **OK**. The **Configure IP Address** window will appear. Enter the IP address information appropriate to your network by following the on-screen instruction.

- 14 When the On-Line Registration screen is displayed, make your selection and follow the on-screen instructions.

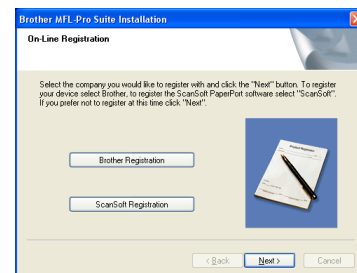

- 15 When the following screen appears, click **Finish** and wait as the PC restarts Windows® and continues the installation. (For Windows® 2000 Professional/XP/Windows NT® 4.0, you must be logged on with Administrator rights.)

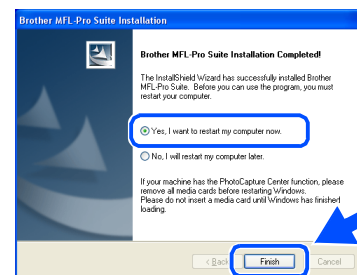

- OK!** The MFL-Pro Suite, Network Printer driver, Network Scanner driver have been installed and the installation is now complete.



- For Network installations, the **Repair MFL-Pro Suite** selection from the main menu is not supported.
- Network Scanning is not supported in Windows NT® 4.0.

## For USB Interface Cable Users

### For Mac OS<sup>®</sup> 9.1 to 9.2

Make sure that you have completed the instructions from Step 1 “Setting Up the MFC” on pages 4 - 11.

- 1 Turn off and unplug the MFC from the AC outlet and disconnect it from your Macintosh<sup>®</sup>, if you already connected an interface cable.

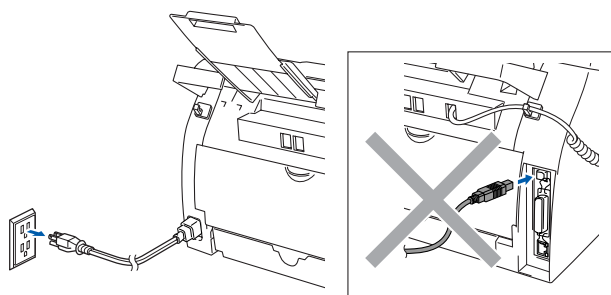

- 2 Turn on your Macintosh<sup>®</sup>.
- 3 Insert the supplied CD-ROM for Macintosh<sup>®</sup> into your CD-ROM drive.



- 4 Double-click the **Start Here OS 9.1-9.2** icon to install the printer and scanner drivers. If the language screen appears, select your language.

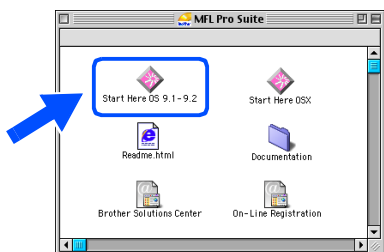

- 5 Click **MFL-Pro Suite** to install.

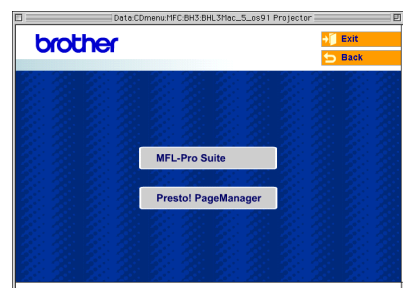

- 6 Follow the on-screen instructions, and restart your Macintosh<sup>®</sup>.
- 7 Connect the USB interface cable to your Macintosh<sup>®</sup>, and then connect it to the MFC.

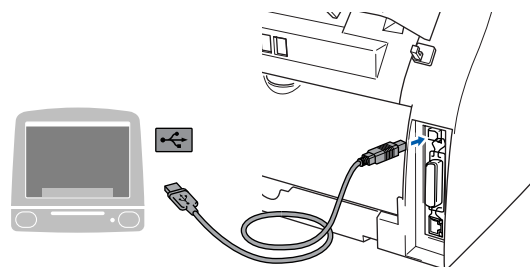

**DO NOT** connect the MFC to a USB port on a keyboard or a non-powered USB hub.

- 8 Plug in the power cord and turn on the MFC.

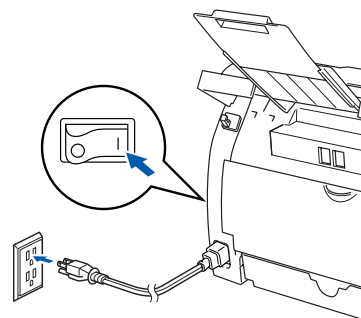

- 9 From the Apple® menu, open the **Chooser**.



- 10 Click the **Brother Laser** icon. On the right side of the **Chooser**, select the MFC to which you want to print. Close the **Chooser**.

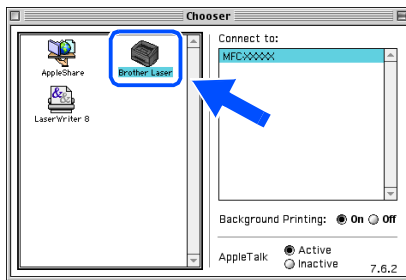

- OK! The **MFL-Pro Suite, Printer driver and Scanner driver** have been installed.

*The ControlCenter2.0 is not supported in Mac OS® 9.x.*

- 11 To install Presto!® PageManager®, click the **Presto! PageManager** icon and follow the on-screen instructions.

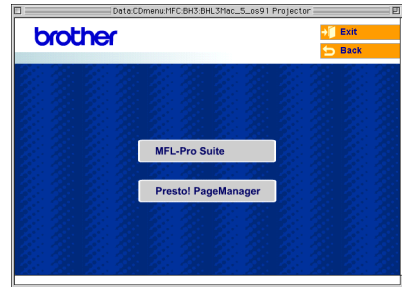

*You can easily scan, share and organize photos and documents using Presto!® PageManager®.*

- OK! **Presto!® PageManager®** has been installed and the installation is now complete.

## For USB Interface Cable Users

### For Mac OS® X 10.2.4 or greater

Make sure that you have completed the instructions from Step 1 “Setting Up the MFC” on pages 4 - 11.



For Mac OS® X 10.2.0 to 10.2.3 user, please upgrade to Mac OS® X 10.2.4 or greater. (The latest information for Mac OS® X, please visit at: <http://solutions.brother.com>)

- 1 Turn off and unplug the MFC from the AC outlet and disconnect it from your Macintosh®, if you already connected an interface cable.

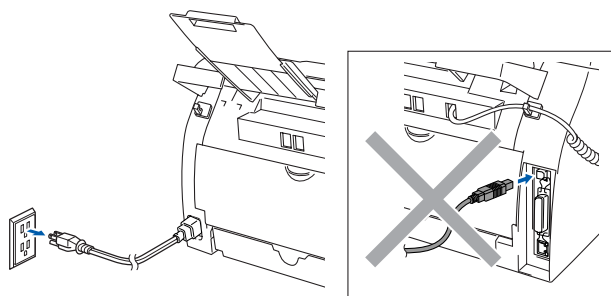

- 2 Turn on your Macintosh®.
- 3 Insert the supplied CD-ROM for Macintosh® into your CD-ROM drive.



- 4 Double-click the **Start Here OSX** icon to install the drivers and MFL-Pro Suite. If the language screen appears, select your language.



- 5 Click **MFL-Pro Suite** to install.

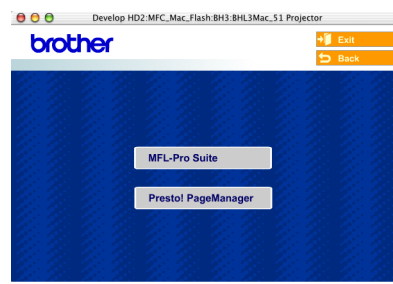

- 6 Follow the on-screen instructions, and restart your Macintosh®.

- 7 After the **DeviceSelector** window appears, connect the USB interface cable to your Macintosh® and then to the MFC.



The **DeviceSelector** window will not appear if you have connected a USB interface cable to the MFC before restarting your Macintosh® or if you are overwriting a previously installed version of the Brother software. If you encounter this problem continue with the installation but skip step 9. You should select your Brother machine from the Model pull-down list in the main screen of ControlCenter2.0.

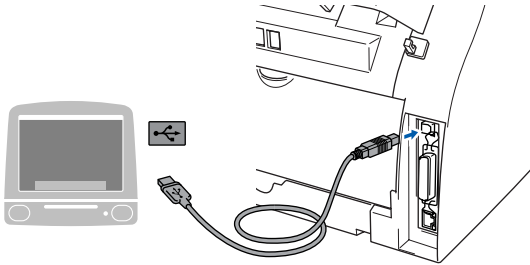

**DO NOT** connect the MFC to a USB port on a keyboard or a non-powered USB hub.

8 Plug in the power cord and turn on the MFC.

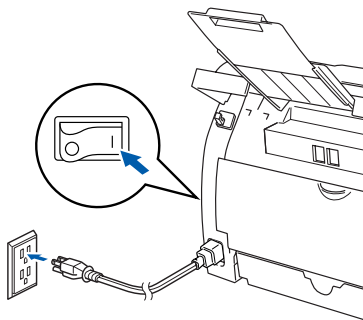

9 Select **USB** and then click **OK**.



10 Select **Applications** from the **Go** menu.

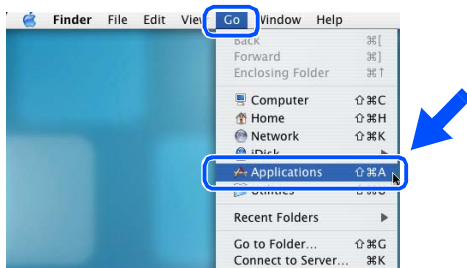

11 Open the **Utilities** folder.



12 Open the **Print Setup Utility** icon.



*For Mac OS® X 10.2.x users, open **Print Center** icon.*

13 Click **Add**.

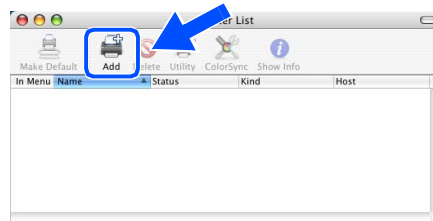

14 Select **USB**.

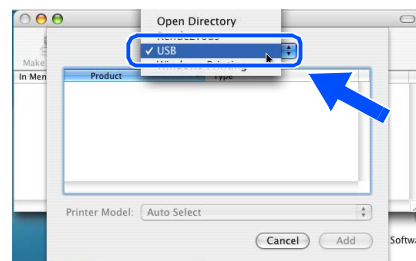

Continued ...



## For USB Interface Cable Users

- 15 Select **MFC-XXXX** (XXXX is your model name), and then click **Add**.

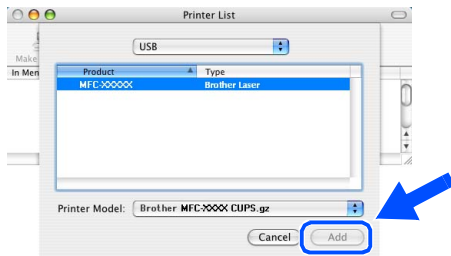

- 16 Select **Quit Printer Setup Utility** from the **Printer Setup Utility** menu.

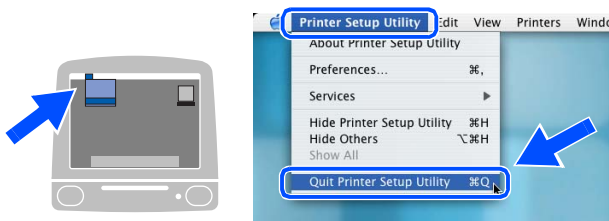

- OK!** The MFL-Pro Suite, Printer driver, Scanner driver and ControlCenter2.0 have been installed.

- 17 To install Presto!® PageManager®, click the **Presto! PageManager** icon and follow the on-screen instructions.

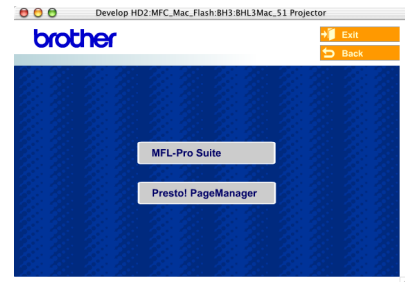

*When Presto!® PageManager® is installed OCR capability is added to the Brother ControlCenter2.0. You can also easily scan, share, and organize photos and documents using Presto!® PageManager®.*

- OK!** Presto!® PageManager® has been installed and the installation is now complete.

## For Network Interface Cable Users (MFC-7225N only)

### For Mac OS® 9.1 to 9.2

Make sure that you have completed the instructions from Step 1 “Setting Up the MFC” on pages 4 - 11.

- 1 Turn off and unplug the MFC from the AC outlet.

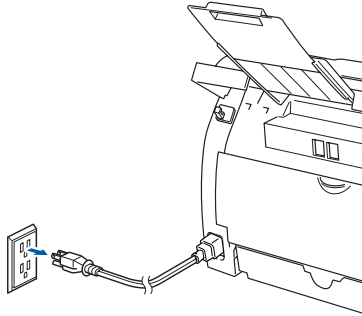

- 2 Turn on your Macintosh®.
- 3 Insert the supplied CD-ROM for Macintosh® into your CD-ROM drive.



- 4 Double-click the **Start Here OS 9.1-9.2** icon to install the printer driver. If the language screen appears, select your language.

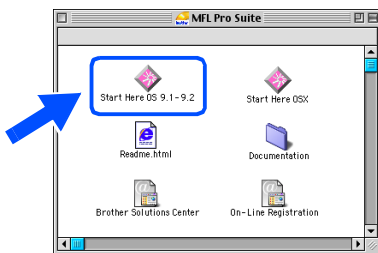

- 5 Click **MFL-Pro Suite** to install.



- 6 Follow the on-screen instructions, and restart your Macintosh®.

- 7 Connect the network interface cable to the MFC, and then connect it to a free port on your hub.

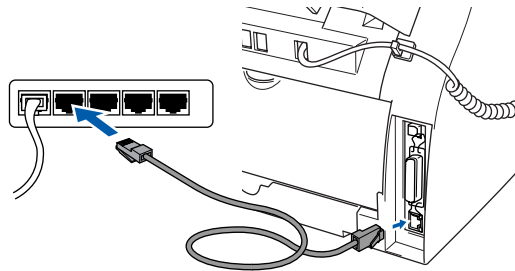

- 8 Plug in the power cord and turn on the MFC.

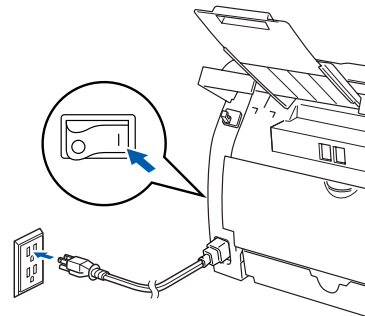

- 9 Open the **Chooser** from the **Apple** menu.



Continued ...



## For Network Interface Cable Users (MFC-7225N only)

- 10 Click the **Brother Laser (IP)** icon, and then select **BRN\_XXXXXX**.  
Close the **Chooser**.

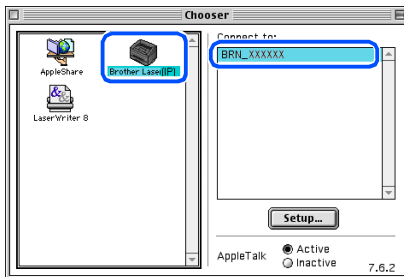

*XXXXXX are the last six digits of the Ethernet address.*



**The MFL-Pro Suite and Printer driver have been installed.**



*The ControlCenter2.0 is not supported in Mac OS® 9.x.*



# For Mac OS® X 10.2.4 or greater

Make sure that you have completed the instructions from Step 1 “Setting Up the MFC” on pages 4 - 11.

- 1 Turn off and unplug the MFC from the AC outlet.

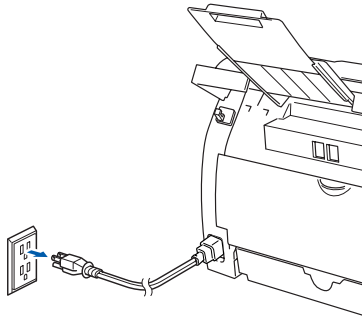

- 2 Turn on your Macintosh®.



If you are using the optional NC-2200w External Wireless Print/Scan Server, follow installation steps 1 to 3 in the NC-2200w Quick Setup Guide first.

- 3 Insert the supplied CD-ROM for Macintosh® into your CD-ROM drive.



- 4 Double-click the **Start Here OSX** icon to install the drivers and MFL-Pro Suite. If the language screen appears, select your language.



- 5 Click **MFL-Pro Suite** to install.



- 6 Follow the on-screen instructions, and restart your Macintosh®.
- 7 After the **DeviceSelector** window appears, connect the network interface cable to the MFC, and then connect it to a free port on your hub.



The **DeviceSelector** window will not appear if you have also connected a USB interface cable to the MFC before restarting your Macintosh® or if you are overwriting a previously installed version of the Brother software. If you encounter this problem continue with the installation skipping steps 9 to 11 and then see the Software User's Guide for details on selecting which MFC the ControlCenter2.0 will connect with.

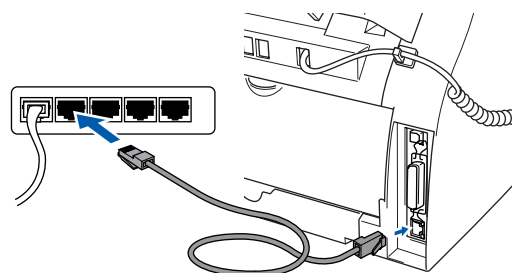

# Step 2

# Installing the Drivers & Software



For Network Interface Cable Users (MFC-7225N and Optional NC-2200w only)

8 Plug in the power cord and turn on the MFC.

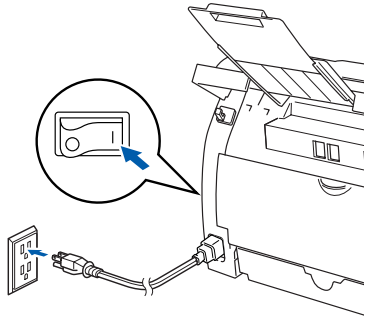

12 Select **Applications** from the **Go** menu.

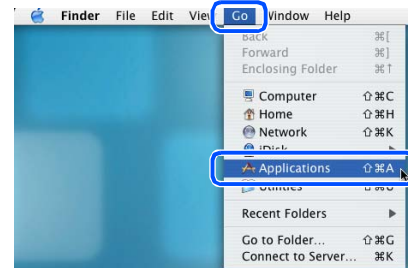

9 Select **Network** and then click **OK**.

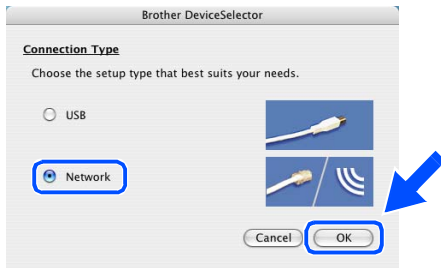

13 Open the **Utilities** folder.

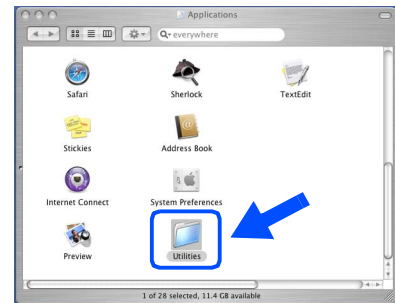

10 Click **Browse**.

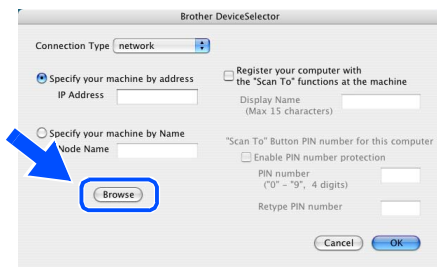

14 Open the **Print Setup Utility** icon.



11 Select your model name, and then click **OK**. Click **OK** again to close the **DeviceSelector**.

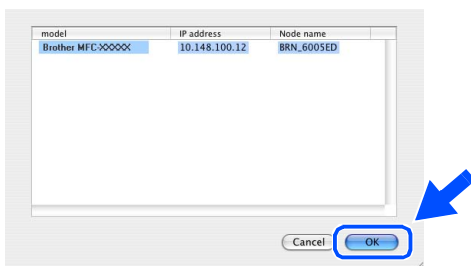

For Mac OS® X 10.2.x users, open **Print Center** icon.

15 Click **Add**.

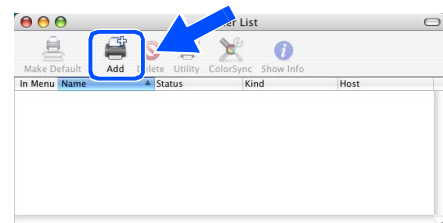

16 Make the selection shown below.

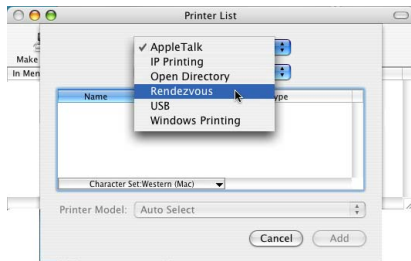

17 Select **Brother MFC-7225N** and then click the **Add** button.

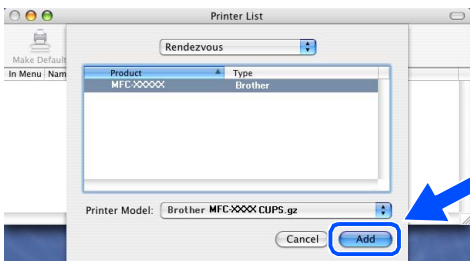

18 Select **Quit Printer Setup Utility** from the **Printer Setup Utility** menu.

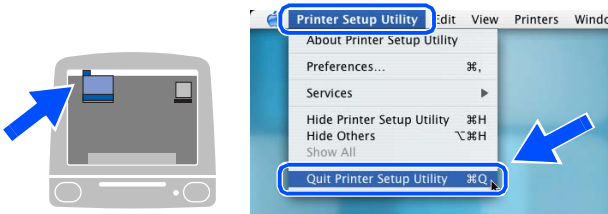

OK! The MFL-Pro Suite, Printer driver, Scanner driver and ControlCenter2.0 have been installed.

19 To install Presto!® PageManager®, click the **Presto! PageManager** icon and follow the on-screen instructions.



*When Presto!® PageManager® is installed OCR capability is added to the Brother ControlCenter2.0. You can also easily scan, share, and organize photos and documents using Presto!® PageManager®.*

OK! Presto!® PageManager® has been installed and the installation is now complete.

## Installing the BRAdmin Professional Configuration Utility (Windows<sup>®</sup> only)

The BRAdmin Professional utility is designed to manage your Brother network connected devices such as network-ready Multifunction devices and/or network-ready printers in a Local Area Network (LAN) environment.

BRAdmin Professional can also be used to manage devices from other manufacturers whose products support SNMP (Simple Network Management Protocol).

For more information on BRAdmin Professional go to <http://solutions.brother.com>

- 1 Insert the supplied CD-ROM into your CD-ROM drive.  
The opening screen will appear automatically.  
Follow the on-screen instructions.



- 2 Click the **Install Optional Applications** icon on the main menu screen.

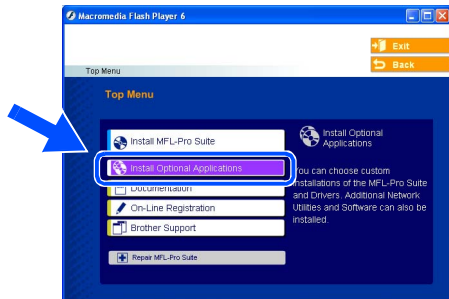

- 3 Click **BRAdmin Professional** and follow the on-screen instructions.

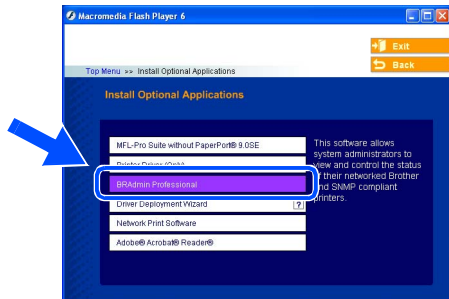

The default password for the print server is **“access”**. You can use BRAdmin Professional or a web browser to change this password.

# Setting your IP Address, Subnet Mask and Gateway using BRAdmin Professional (Windows® Users Only)

- 1 Start BRAdmin Professional, and select **TCP/IP**.

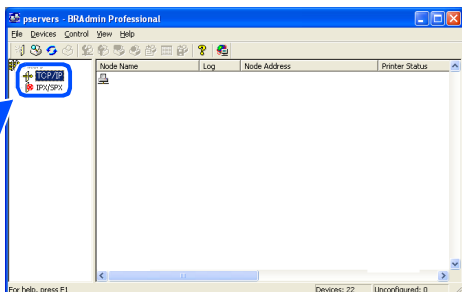

- 2 Select **Search Active Devices** from the **Devices** menu. BRAdmin will search for new devices automatically.

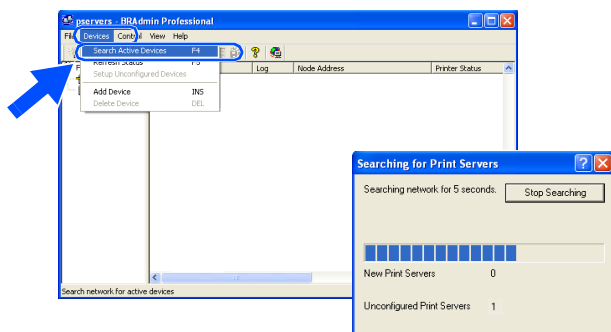

- 3 Double-click the new device.

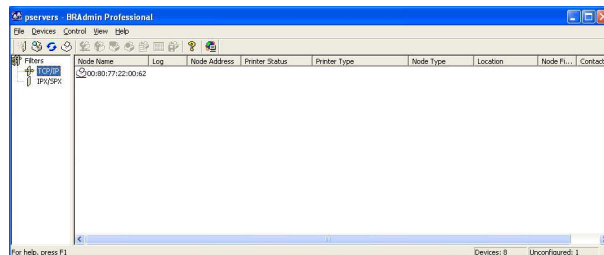

- 4 Enter the **IP Address**, **Subnet Mask** and **Gateway**, and then click the **OK** button.

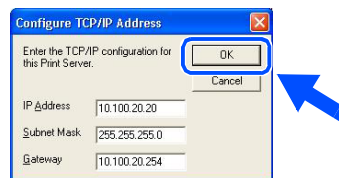

- 5 The address information will be saved to the printer.





For more information on network administration, please see the *Network User's Guide* in the programs menu or go to <http://solutions.brother.com>

# Options and Consumables

## Options

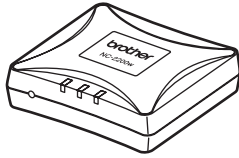
The MFC has the following optional accessories. You can expand the capabilities of the MFC by adding these items.

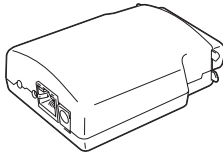
External Wireless Print/Scan Server	External Print Server
<b>NC-2200w</b>	<b>NC-2100p</b>
<div style="text-align: center;"></div> <p>If you are going to connect the MFC to your wireless network, purchase the optional Wireless print/scan server (802.11b). The NC-2200w can be connected to the USB interface port of your MFC.</p> <p>For more information, visit <a href="http://solutions.brother.com">http://solutions.brother.com</a>.</p> <p> • USB cable is not included. • You can assign the Scan key to one networked computer only. • Support for Mac OS® X 10.2.4 or greater.</p>	<div style="text-align: center;"></div> <p>If you are going to connect the MFC-7220 to your Ethernet network, buy the optional Network device. The NC-2100p can be connected to the parallel interface port of your MFC.</p> <p>For more information, visit <a href="http://solutions.brother.com">http://solutions.brother.com</a>.</p>

## Replacement Consumables

When the time comes to replace consumables, an error message will be indicated on the LCD. For more information about the consumables for your printer, visit <http://solutions.brother.com> or contact your local Brother re-seller.

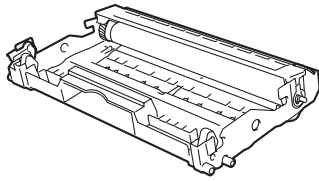
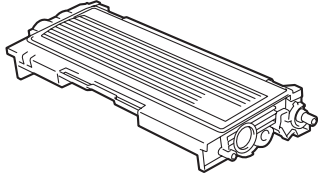
Drum Unit	Toner
<b>DR-350</b>	<b>TN-350</b>
<div style="text-align: center;"></div>	<div style="text-align: center;"></div>

## Trademarks

The Brother logo is a registered trademark of Brother Industries, Ltd.

Brother is a registered trademark of Brother Industries, Ltd.

Multi-Function Link is a registered trademark of Brother International Corporation.

© 2005 Brother Industries, Ltd. All rights reserved.

Windows, Microsoft and Windows NT are registered trademarks of Microsoft in the U.S. and other countries.

Macintosh, QuickDraw, iMac and iBook are trademarks or registered trademarks of Apple Computer, Inc.

Postscript and Postscript Level 3 are registered trademarks or trademarks of Adobe Systems Incorporated.

PaperPort and OmniPage are registered trademarks of ScanSoft, Inc.

Presto! PageManager is a registered trademark of NewSoft Technology Corporation.

Each company whose software title is mentioned in this manual has a Software License Agreement specific to its proprietary programs.

**All other brand and product names mentioned in this manual are registered trademarks of their respective companies.**

## Compilation and Publication

Under the supervision of Brother Industries Ltd., this manual has been compiled and published, covering the latest product descriptions and specifications.

The contents of this manual and the specifications of this product are subject to change without notice.

Brother reserves the right to make changes without notice in the specifications and materials contained herein and shall not be responsible for any damages (including consequential) caused by reliance on the materials presented, including but not limited to typographical and other errors relating to the publication.

This product is designed for use in a Professional Environment.

©2005 Brother Industries, Ltd. ©1998-2005 TROY Group, INC.

©1983-2005 PACIFIC SOFTWARES INC.

**brother**®

USA/CAN