

brother®

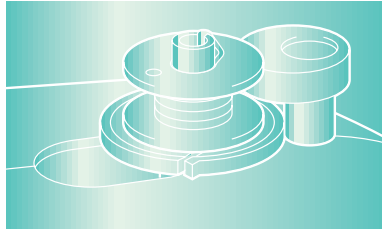

Sewing Machine

OPERATION MANUAL

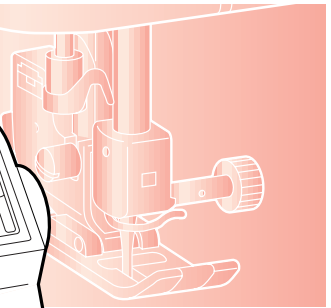
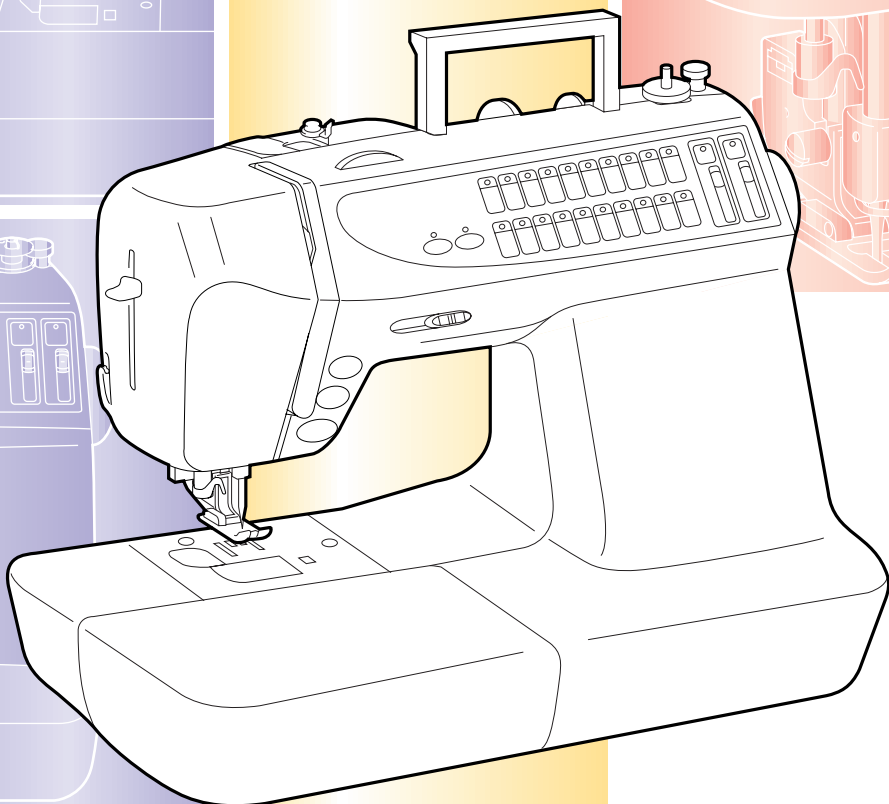

IMPORTANT SAFETY INSTRUCTIONS

When using this machine, basic safety precautions should always be taken, including the following:

Read all instructions before using.

DANGER - To reduce the risk of electric shock:

1. The machine should never be left unattended while plugged in. Always unplug the machine from the electrical outlet immediately after using and before cleaning.
2. Always unplug before changing the light bulb. Replace bulb with same type rated 12V 5 watts.

WARNING - To reduce the risk of burns, fire, electric shock, or injury to persons:

1. Do not allow this machine to be used as a toy. Close attention is necessary when the machine is used by or near children.
2. Use this machine only for its intended use as described in this manual. Use only accessories recommended by the manufacturer as contained in this manual.
3. Never operate this machine if it has a damaged cord or plug, if it is not working properly, if it has been dropped or damaged, or dropped into water. Return the machine to the nearest authorized dealer or service center for examination, repair, electrical or mechanical adjustment.
4. Never operate the machine with any air openings blocked. Keep ventilation openings of the machine and foot control free from the accumulation of lint, dust, and loose cloth.
5. Never drop or insert any object into any opening.
6. Do not use outdoors.
7. Do not operate where aerosol (spray) products are being used or where oxygen is being administered.
8. To disconnect, turn the main switch to the symbol "O" position which represents off, then remove plug from outlet.
9. Do not unplug by pulling on cord. To unplug, grasp the plug, not the cord.
10. Keep fingers away from all moving parts. Special care is required around the machine needle.
11. Always use the proper needle plate. The wrong plate can cause the needle to break.
12. Do not use bent needles.
13. Do not pull or push fabric while stitching. It may deflect the needle causing it to break.
14. Switch the machine to the symbol "O" position when making any adjustments in the needle area, such as threading needle, changing needle, threading bobbin, or changing presser foot, and the like.
15. Always unplug the machine from the electrical outlet when removing covers, lubricating, or when making any other user servicing adjustments mentioned in the instruction manual.
16. This sewing machine is not intended for use by young children or infirm persons without supervision.
17. Young children should be supervised to ensure that they do not play with this machine.

SAVE THESE INSTRUCTIONS

This machine is intended for household use.

FOR USERS IN THE UK, EIRE, MALTA AND CYPRUS ONLY

If this machine is fitted with a three-pin non-rewireable BS plug then please read the following.

IMPORTANT

If the available socket outlet is not suitable for the plug supplied with this equipment, it should be cut off and an appropriate three-pin plug fitted. With alternative plugs an approved fuse must be fitted in the plug.

NOTE

The plug served from the main lead must be destroyed as a plug with bared flexible cords is hazardous if engaged in a live socket outlet. In the event of replacing the plug fuse, use a fuse approved by ASTA to BS 1362, i.e. carrying the  mark, rating as marked on plug. Always replace the fuse cover, never use plugs with the fuse cover omitted.

WARNING

DO NOT CONNECT EITHER WIRE TO THE EARTH TERMINAL WHICH IS MARKED WITH THE LETTER 'E', BY THE EARTH SYMBOL  OR COLOURED GREEN OR YELLOW.

The wires in this main lead are coloured in accordance with the following code:

Blue Neutral

Brown Live

As the colours of the wiring in the main lead of this appliance may not correspond with the coloured markings identifying the terminals in your plug, proceed as follows.

The wire which is coloured blue must be connected to the terminal which is marked with the letter 'N' or coloured black or blue.

The wire which is coloured brown must be connected to the terminal which is marked with the letter 'L' or coloured red or brown.

CONGRATULATIONS ON CHOOSING OUR MACHINE

Your machine is the most advanced computerized household sewing machine. To fully enjoy all the features incorporated, we suggest that you study the manual.

PLEASE READ BEFORE USING THIS MACHINE

For safe operation

1. Be sure to keep your eye on the needle while sewing. Do not touch the balance wheel, thread take-up, needle, or other moving parts.
2. Remember to turn off the power switch and unplug the cord when:
 - Operation is completed
 - Replacing or removing the needle or any other parts
 - A power failure occurs during use
 - Maintaining the machine
 - Leaving the machine unattended.
3. Do not store anything on the foot controller.
4. Plug the machine directly into the wall. Do not use extension cords.

For a longer service life

1. When storing this machine, avoid direct sunlight and high humidity locations. Do not use or store the machine near a space heater, iron, halogen lamp, or other hot objects.
2. Use only neutral soaps or detergents to clean the case. Benzene, thinner, and scouring powders can damage the case and machine, and should never be used.
3. Do not drop or hit the machine.
4. Always consult the operation manual when replacing or installing any assemblies, the presser feet, needle, or other parts to assure correct installation.

For repair or adjustment

In the event a malfunction occurs or adjustment is required, first follow the troubleshooting table in the back of the operation manual to inspect and adjust the machine yourself. If the problem persists, please consult your local authorized Brother dealer.

For additional product information and updates, visit our web site at www.brother.com

CONTENTS

CHAPTER 1

BEFORE USE





.....	4
PART NAMES	4
STANDARD ACCESSORIES	6
OPTIONAL ACCESSORIES	6
OPERATION PANEL	7
OPERATION BUTTONS	8
Using the operation buttons	8
POWER SUPPLY	9
BOBBIN WINDING /	
BOBBIN THREAD SETTING	10
Winding the bobbin and setting the bobbin	
thread	10
Setting the bobbin	12
UPPER THREADING	13
Using the extra spool pin and the net	16
STARTING AND STOPPING SEWING	17
"START/STOP" button	17
Foot controller	17
SELECTING A STITCH PATTERN	18
Quick adjustment reference chart for stitch	
width and stitch length	19
THREAD TENSION	20
Correct upper thread tension	20
Loosening the upper thread tension	20
Tightening the upper thread tension	21
PRESSER FOOT	22
Changing the presser foot	22
Removing the presser foot holder	
(while cleaning, etc.)	22
ATTACHING THE OPTIONAL WALKING FOOT	23
FEED DOG	24
NEEDLE	25
Checking the needle	25
Installing the needle securely	25
FABRIC/THREAD/NEEDLE COMBINATION	
CHART	26

CHAPTER 2

1. SEWING

.....	27
TRIAL SEWING	27
Sewing using a utility stitch	27
SETTING THE NEEDLE STOP DOWN	
POSITION	29
Canceling the needle stop down position	
setting	29
STITCH WIDTH AND LENGTH	30
Adjusting the stitch width	30
Adjusting the stitch length	30
USEFUL SKILLS	31
Sewing corners	31
Sewing curves	31
Sewing heavyweight fabrics	32
Sewing lightweight fabrics	32
Using the needle plate	33
Free-arm sewing	33

2. UTILITY STITCHES

.....	34
STRAIGHT STITCHES	34
Sewing stretch fabrics	35
Changing the stitch length	35
Changing the needle position	
(only "P" straight stitch (left) and "5" triple	
stretch stitch)	35
ZIGZAG STITCHES	36
Overcasting (using a zigzag stitch)	36
Appliqué (using a zigzag stitch)	36
Patchwork (for crazy quilts)	36
Sewing curves (using a zigzag stitch)	36
OVERCASTING STITCHES	37
Sewing using stitch  or 	37
Sewing using stitch  or 	37
OVERCASTING	
(WHEN USING THE	
OPTIONAL SIDE CUTTER)	38
BLIND HEM STITCHING	40
Adjusting the needle drop point	41
BUTTONHOLE STITCHING	42
Buttonhole sewing order	44
Sewing stretch fabrics ("13" and "14")	44
Odd shaped buttons/Buttons that do not fit	
into the button holder plate	45
Changing the stitch length	46
Changing the stitch width	46
EYELET STITCH	47
Size of eyelet (actual size)	47
ZIPPER INSERTION	48
Centered zipper	48
Inserting a side zipper	49
DART SEAM	51
GATHERING	52
Pulling up the bobbin thread	53
PINTUCK	54
FLAT FELL SEAM	55
Finished flat fell seam	56
APPLIQUÉS	57
Sewing sharp curves	57
SCALLOP STITCH	58
SMOCKING STITCH	59
FAGOTING	60
DECORATIVE STITCHING	61
Decorative stitching	61
Changing the size of a decorative stitch	61
HEMSTITCH (HEIRLOOM STITCH)	62
Hemstitching 1	62
Hemstitching 2	63
TWIN NEEDLE	64
SEWING	66
Sewing attractive finishes	66

MAINTENANCE

.....	67
CLEANING THE MACHINE	67
Cleaning the operation panel	67
Cleaning the machine casing	67
Cleaning the race and shuttle	67
CHANGING THE LIGHT BULB	69
TROUBLE SHOOTING	70
Trouble with threads and stitches	70
Mechanical trouble	71
Alarm	71

SEWING CHART

.....	72
-------	-----------

PATTERNS**(PROGRAMMED IN MACHINE)**

.....	75
Utility stitches	75
Decorative stitches	75

PART NAMES

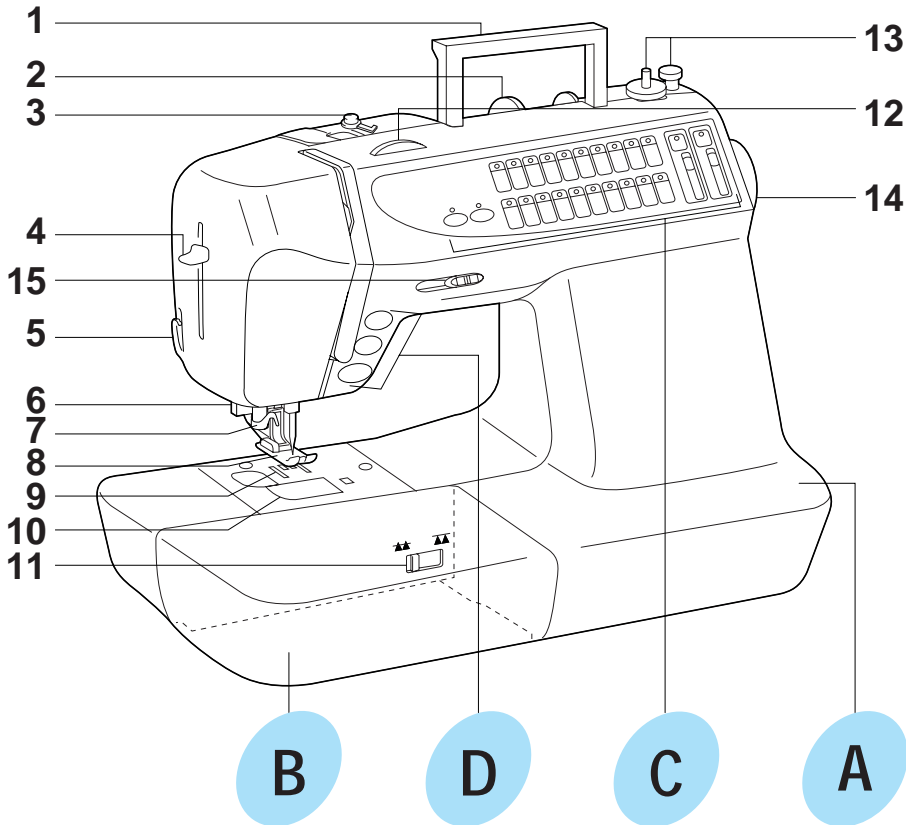

- 1- Handle
- 2- Spool cap
- 3- Thread guide for bobbin winding
- 4- Needle threader lever
- 5- Thread cutter
- 6- Buttonhole lever
- 7- Needle threader
- 8- Presser foot
- 9- Feed dog
- 10- Bobbin cover
- 11- Feed dog position switch
- 12- Upper tension control dial
- 13- Bobbin winder
- 14- Balance wheel
- 15- Sewing speed controller

- A- Main power switch and connectors
- B- Accessory compartment
- C- Operation panel
- D- Operation buttons

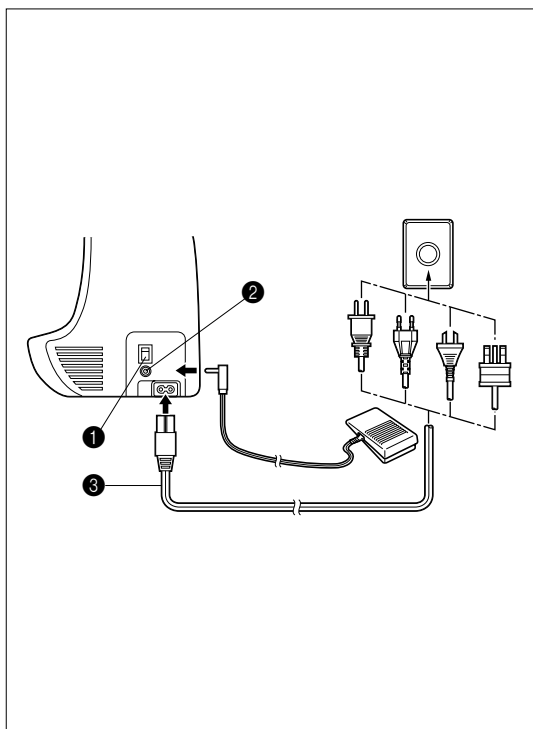

A. MAIN POWER SWITCH AND CONNECTORS

- ❶ **Main power switch**
Use to turn on/off the main power.
- ❷ **Foot controller jack**
Use to connect the foot controller.
- ❸ **Power cord**
Use to connect the machine to the power supply.

CAUTION

- When leaving the machine unattended, the main switch of the machine should be switched off or the plug must be removed from the socket-outlet.
- When servicing the machine, or when removing covers or changing bulbs, the machine or the electrical set must be unplugged.
- For U.S.A. only
This appliance has a polarized plug (one blade wider than the other). To reduce the risk of electrical shock, this plug is intended to fit in a polarized outlet only one way. If the plug does not fit fully in the outlet, reverse the plug. If it still does not fit, contact a qualified electrician to install the proper outlet. Do not modify the plug in any way.

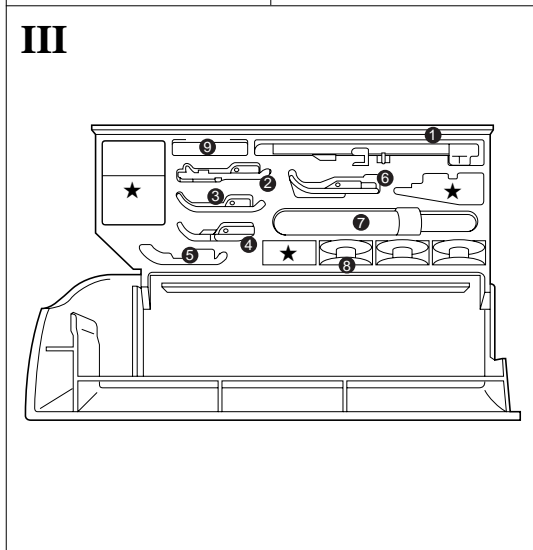
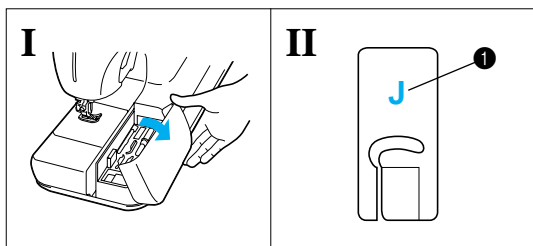

B. FLATBED ATTACHMENT WITH ACCESSORY COMPARTMENT

- I Tilt the lid of the accessory compartment toward you to open it.
- II Each presser foot can be identified by the symbol on it.
- ❶ **Presser foot symbol**
- III **COMPARTMENT ACCESSORY LIST**
The location of each accessory is shown in figure III.

No.	Part Name	Part Code	
		U.S.A.	Others
❶	Buttonhole foot "A"	X57789-101	
❷	Overcasting foot "G"	X51162-001	
❸	Monogramming foot "N"	137988-101	
❹	Zipper foot "I"	X59370-051	
❺	Space for Zigzag foot "J" *	137748-101	
❻	Blind stitch foot "R"	X56409-001	
❼	Seam ripper	X54243-001	
❽	Bobbins	SA155	XA3812-051
❾	Needle set	X58358-001	

- * The machine comes with zigzag foot "J" attached.
- * The spaces marked with "★" are empty. No enclosed accessories fit in these spaces.
- * Always use the plastic bobbin which is supplied with the machine or in the accessory compartment.
- * Always use accessories recommended for this machine.

STANDARD ACCESSORIES

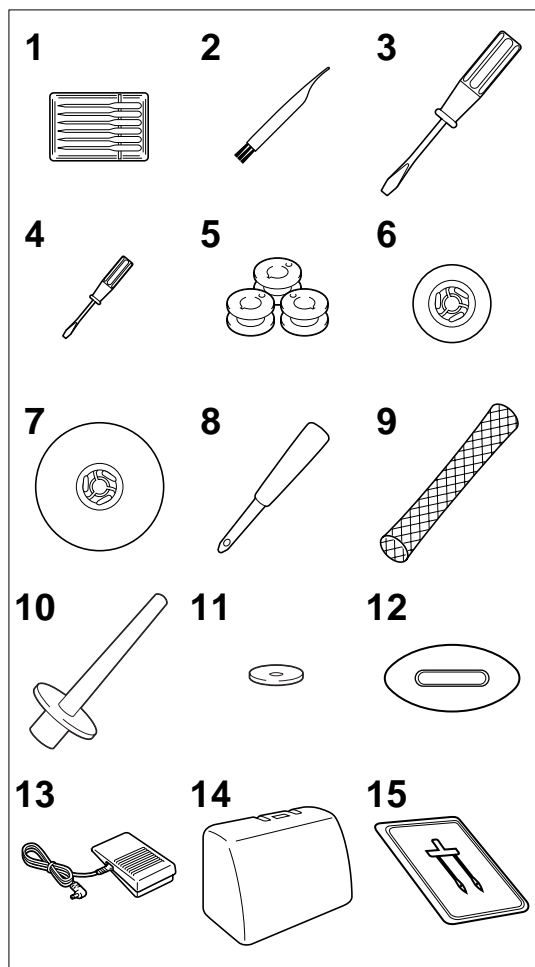

No.	Part Name	Part Code	
		U.S.A.	Others
1	Needle set		
	75/11: 2 pcs		
	90/14: 2 pcs		X58358-001
	90/14 Ball point needle (gold colored) (for stretch fabrics): 2 pcs		
2	Cleaning brush		X59476-051
3	Screwdriver (large)		X55467-051
4	Screwdriver (small)		X55468-051
5	Bobbin (3)	SA155	XA3812-051
6	Spool cap (small)		130013-053
7	Spool cap (large)		130012-053
8	Eyelet punch		135793-001
9	Spool net*		XA5523-050
10	Extra spool pin*		XA3336-051
11	Spool felt		X57045-051
12	Disc-shaped screwdriver		XA2005-051
13	Foot controller		XA3931-051
14	Hard case		XA2482-051
15	Twin needle		X59296-001

- * Always use a thread net with metallic threads.
- * When using special threads which quickly wind off the thread spool, place a net over the spool before sewing.
- * The extra spool pin, which is provided as an accessory, should be attached to the end of the bobbin winder shaft during use.

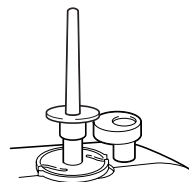
**Note (For U.S.A. only)**

Foot controller: Model N5V

This foot controller can be used on this machine model PC-2800.

OPTIONAL ACCESSORIES

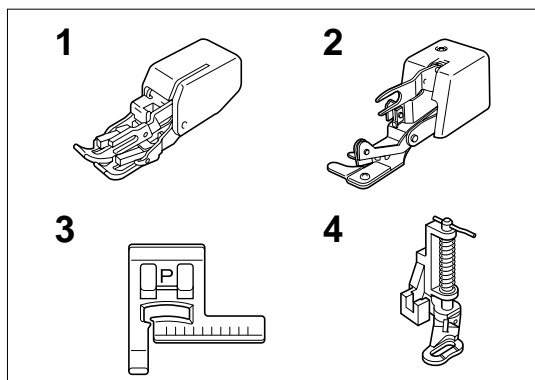
1- Walking foot*
Parts code: SA140, X81065-0022- Side cutter*
Parts code: X81028-0013- Stitch guide foot "P"
Parts code: SA160, XA8839-0024- Quilting foot
Parts code: XA4322-001

- * When using the walking foot, refer to page 23.
- * When using the side cutter, refer to page 38.

OPERATION PANEL

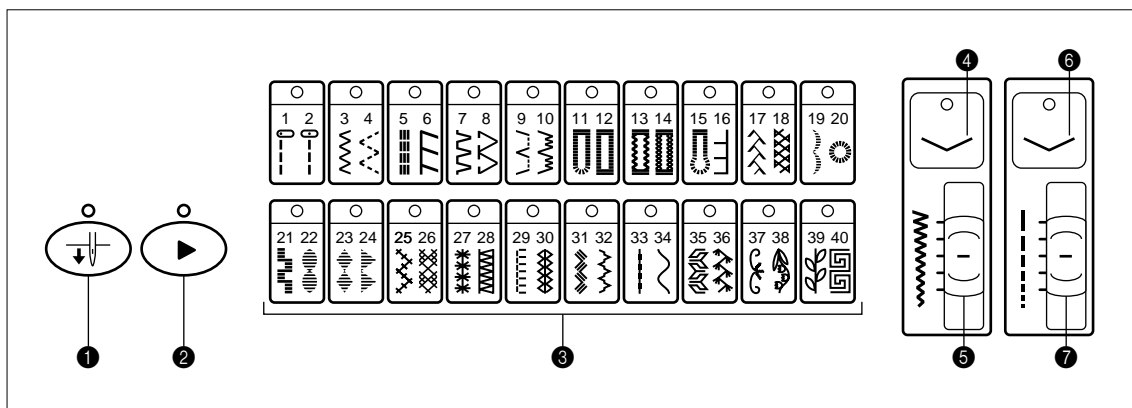

C. OPERATION PANEL

1 Needle stop position switch key

Touch this key to select the needle stop position (the needle position when the machine is not operating) to be up or down.

When the LED lamp is lit, the needle stop position is down. When the LED lamp is turned off, the needle stop position is up.

2 Stitch pattern switch key

Touch this key to switch the stitch pattern selected by the stitch selection key. When the LED lamp is lit, the stitch shown by the mark on the right side of the stitch selection key is selected. When the LED lamp is turned off, the stitch shown by the mark on the left side of the stitch selection key is selected.

3 Stitch selection keys

Touch a key to select the stitch. When the LED lamp is lit, the key is selected.

* To change the selection to the stitch on the right or left, use the stitch pattern switch key (2).

4 Stitch width manual change key

Touch this key when you want to change the width of a zigzag stitch or a decorative stitch. When the LED lamp is lit, you can make adjustments. When the LED lamp is turned off, the stitch width will return to the default value.

5 Stitch width adjustment lever

Use this lever when you want to change the width of a zigzag stitch or a decorative stitch, or when you want to adjust the needle position.

6 Stitch length manual change key

Touch this switch when you want to change the stitch length. When the LED lamp is lit, you can make adjustments. When the LED lamp is turned off, the stitch length will return to the default value.

7 Stitch length adjustment lever

Use this lever when you want to adjust stitch length.

OPERATION BUTTONS

Using the operation buttons

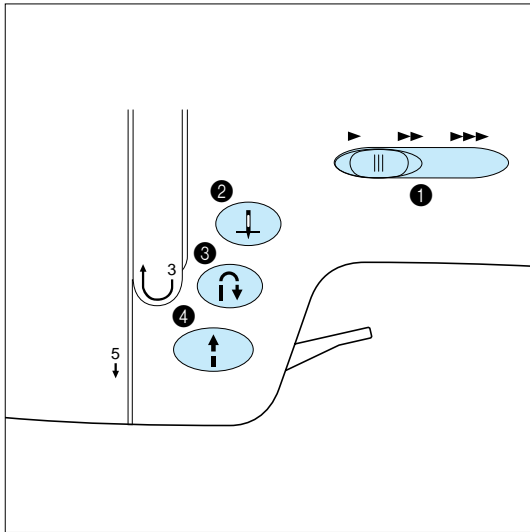

D. OPERATION BUTTONS

- 1 Sewing speed controller**
Slide this lever to change the sewing speed.
- 2 “NEEDLE POSITION” button**
Press this button to move the needle either up or down.
- 3 “REVERSE STITCH” button**
Hold down this button to sew either backwards or in the same place at a slow speed. When sewing a reverse stitch, sewing is done in reverse. When sewing a reinforcement stitch, three stitches are sewn at the same position.
- 4 “START/STOP” button***
This lighted button changes to green when the machine is ready to start or while it is sewing. If the machine cannot be started, this button changes to red. In addition, this button lights up in orange while the bobbin thread is winding onto the bobbin (the bobbin winder shaft is moved to the right).

* Sewing continues at a slow speed while this button is pressed.

POWER SUPPLY

⚠ WARNING

- Use only regular household electricity for the power source. Using other power sources may result in fire, electric shock, or damage to the machine.
- Turn off the main power and remove the plug in the following circumstances:
 - When you are away from the machine
 - After using the machine
 - When the power fails during use
 - When the machine does not operate correctly due to a bad connection or a disconnection
 - During electrical storms

⚠ CAUTION

- Do not use extension cords or multi-plug adapters with many other appliances plugged in to them. Fire or electric shock may result.
- Do not touch the plug with wet hands. Electric shock may result.
- When unplugging the machine, always turn off the main power first. Always grasp the plug to remove it from the outlet. Pulling on the cord may damage the cord, or lead to fire or electric shock.
- Do not allow the power cord to be cut, damaged, modified, forcefully bent, pulled, twisted, or bundled. Do not place heavy objects on the cord. Do not subject the cord to heat. These things may damage the cord and cause fire or electric shock. If the cord or plug is damaged, take the machine to your authorized dealer for repairs before continuing use.
- Unplug the power cord if the machine is not to be used for a long period of time. Otherwise a fire may result.

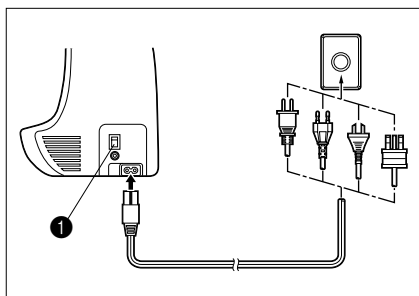

1. Insert the plug into a wall outlet.

① Main power switch

2. Set the main power switch to “ I ”.

3. To turn off the sewing machine, set the main power switch to “ O ”.

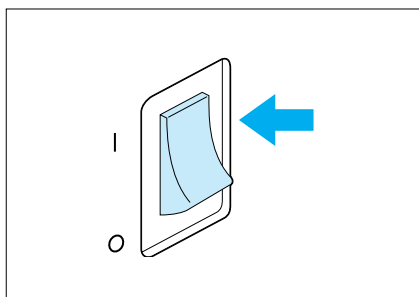

BOBBIN WINDING / BOBBIN THREAD SETTING

Winding the bobbin and setting the bobbin thread

⚠ CAUTION

Use only bobbins recommended by the manufacturer of this machine (see page 5). Using other bobbins may result in damage or injury.

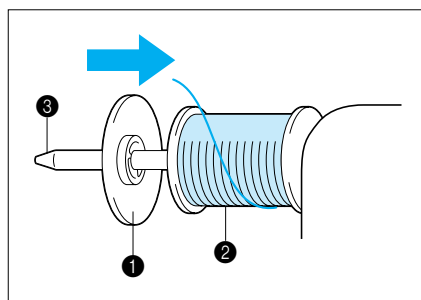
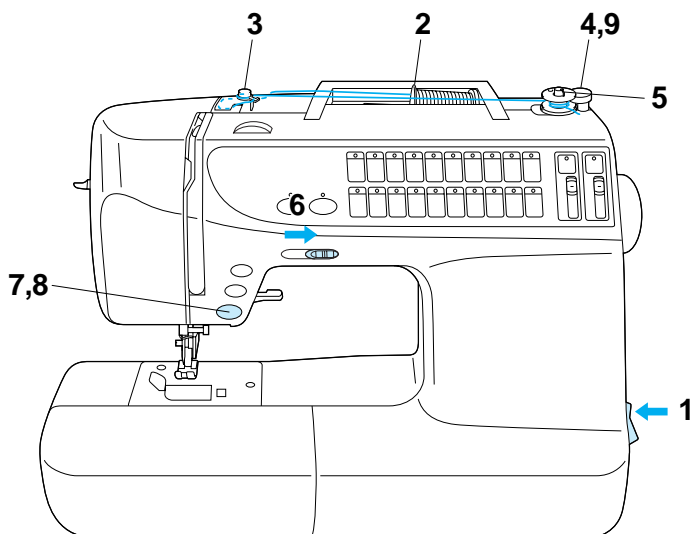

1. Connect the machine to the power supply and turn on the main power.
2. Place the spool of thread on the spool pin. The thread end should come from the bottom front of the spool. The spool cap closest to the thread spool size should be used to hold the spool securely on the spool pin.

- ① Spool cap
- ② Spool
- ③ Spool pin

* The spool cap should be pushed on as far as it will go.

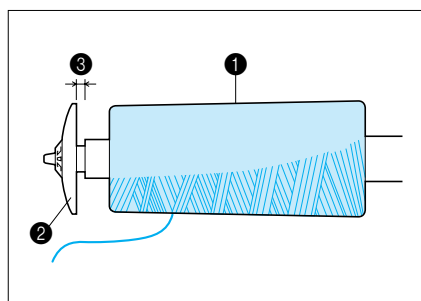

⚠ CAUTION

- If the thread spool and/or spool cap are set incorrectly, the thread may tangle on the spool pin and cause the needle to break.
- Use the spool cap (large or small) that is closest in size to the thread spool. If a spool cap smaller than the thread spool is used, the thread may become caught in the slit on the edge the spool and cause the needle to break.

Note

If using a fine thread such as cross wound thread, slightly separate the spool cap (small) from the spool of thread before using it.

- ① Cross wound thread
- ② Spool cap (small)
- ③ Gap

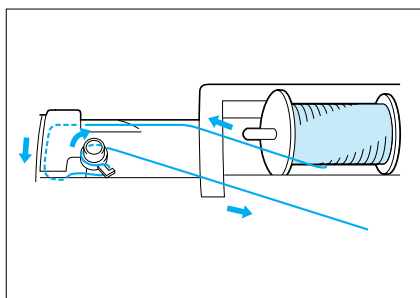

3. Pass the thread through the thread guide as shown by the arrows.

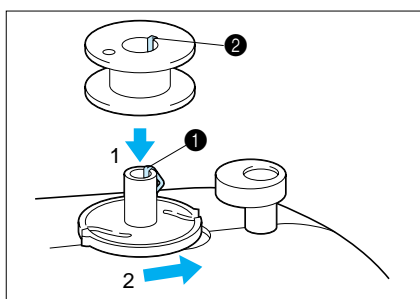

4. Align the groove in the bobbin with the spring on the shaft and place the bobbin on the bobbin winder shaft. Then, push the bobbin winder shaft to the right.

- ❶ Spring on the shaft
- ❷ Groove of the bobbin

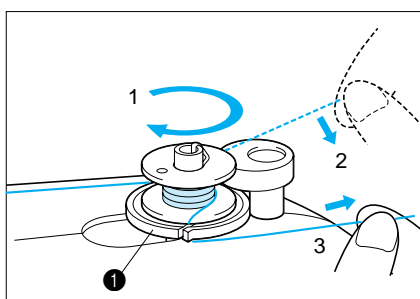

5. Wind the thread clockwise around the bobbin four or five times, pass the end of the thread through the slit in the bobbin winder seat, and then pull the thread in the direction shown in the illustration. Use the cutter to cut the thread.

- ❶ Bobbin winder seat

⚠ CAUTION

Be sure to follow the process described. If the thread is not cut with the cutter, and the bobbin is wound, when the thread runs low it may tangle around the bobbin and cause the needle to break.

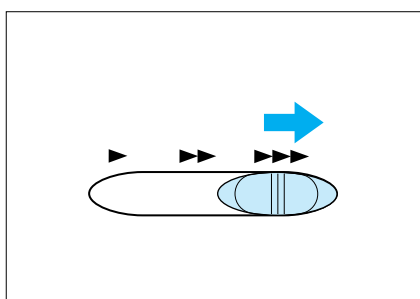

6. Slide the sewing speed controller to its maximum (as far to the right as possible).
7. Press the "START/STOP" button. The bobbin will stop winding when it is full.
8. After the bobbin has stopped moving, press the "START/STOP" button to stop the machine.
9. Cut the thread, slide the bobbin winder shaft to the left and remove the bobbin.

Note

Immediately after winding the bobbin, it is normal to hear the sound of the clutch engaging when beginning to sew or manually turning the balance wheel.

Setting the bobbin

⚠ CAUTION

Setting the bobbin improperly may cause the thread tension to loosen, breaking the needle and resulting in injury.

- ① Wound evenly
- ② Wound poorly

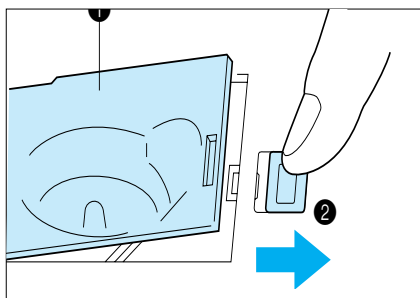
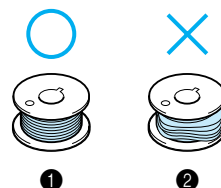

1. Slide open the bobbin cover.

- ① Bobbin cover
- ② Bobbin cover release button

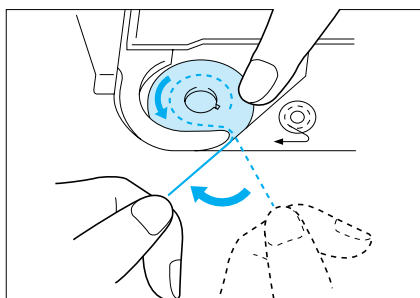

2. Insert the bobbin into the shuttle with the thread direction as shown in the diagram.

⚠ CAUTION

Be sure the bobbin is set so the thread unrolls in the correct direction. If the thread unrolls in the wrong direction, it may cause the thread tension to be incorrect or the needle to break.

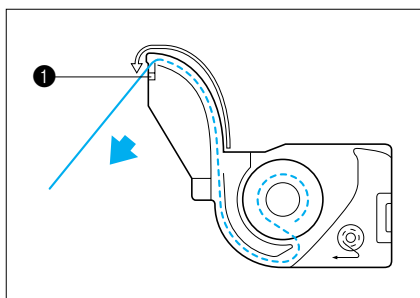

3. Guide the thread end through the slit, then pull the thread toward you to cut off any excess thread.

- ① Built-in thread cutter

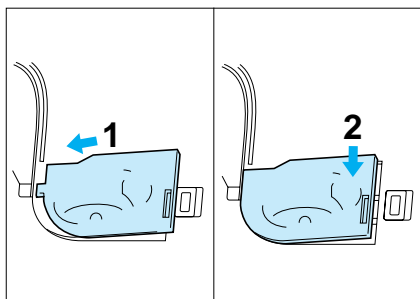

4. Close the bobbin cover by placing the left end in place and pressing down lightly on the right end so that it snaps into place.

* You can begin sewing immediately without drawing up the bobbin thread.

UPPER THREADING

⚠ CAUTION

Be sure to thread the machine properly. Improper threading can cause the thread to tangle and break the needle, leading to injury.

Note

When threading the sewing machine, be sure that one of the presser feet mentioned in this Operation Manual is installed.

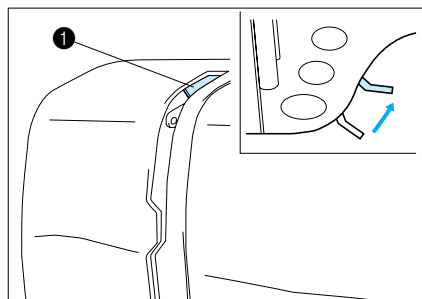
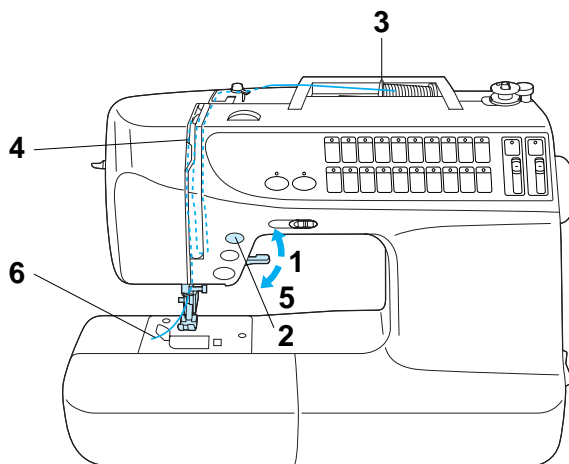

1. Raise the presser foot lever. (If the presser foot is not raised, the upper thread cannot be threaded.)

Note

In order to ensure that the upper threading is done correctly, this sewing machine is equipped with an upper threading shutter which prevents upper threading or needle threading while the presser foot is lowered.

① Upper threading shutter

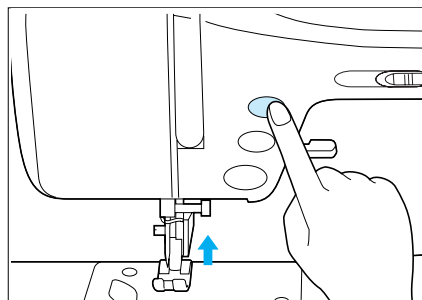

2. Press the "NEEDLE POSITION" button to raise the needle.

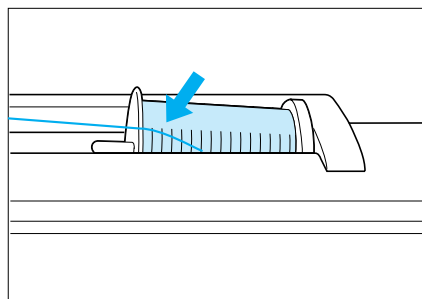

3. Place the spool of thread on the spool pin so that the thread comes from the front of the spool.

⚠ CAUTION

- If the thread spool and/or spool cap are set incorrectly, the thread may tangle on the spool pin and cause the needle to break.
- Use the spool cap (large or small) that is closest in size to the thread spool. If a spool cap smaller than the thread spool is used, the thread may become caught in the slit on the end of the spool and cause the needle to break.

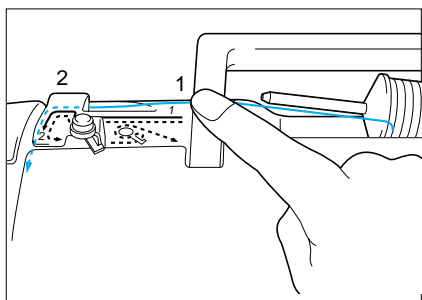

4. While holding the end of the thread with your left hand, pass the thread through the guides in the order shown by the numbers.

Note

- If the thread is pushed down at 1 to make it taut, it can be passed around the other thread guides more easily.
- Incorrectly feeding the thread will result in faulty sewing.

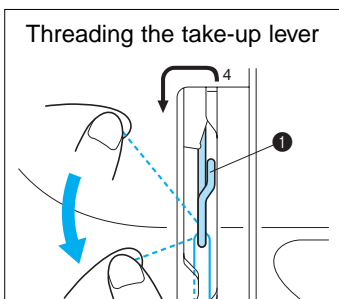
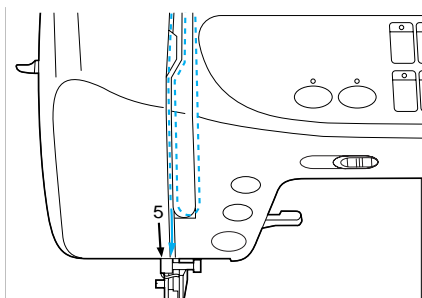

1 Thread take-up lever

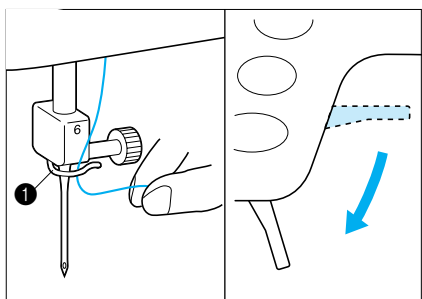

5. Lower the presser foot.
6. Guide the thread through the needle clamp thread guide.

1 Needle clamp thread guide

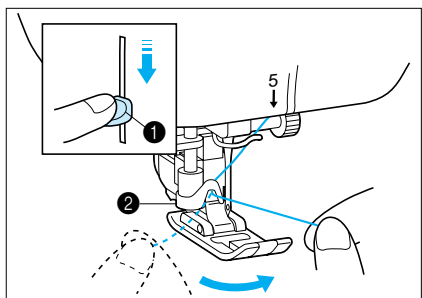

7. When using the auto-threading device, gently pull the thread towards you.

1 Needle threader lever

2 Guide (Large hook)

- * Lowering the presser foot will engage the automatic tension and will allow you to grip the thread as you proceed.

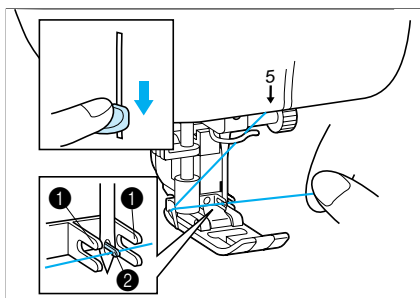

8. Lower the needle threader lever all the way down using your left index finger. Check that the thread is held by the guide (large hook) and that the third hook on the needle threader has passed through the eye of the needle.

- ❶ Second set of hooks
- ❷ Third hook

9. As you lower the needle threader lever, pull the thread to the left and catch it on the large hook. When the needle threader lever is in the lowest position, pull the thread in front of the needle's eye and catch it on the third hook.

* Rotate your right hand slightly to check that the thread is engaged.

10. While gently holding the thread, raise the needle threader lever.

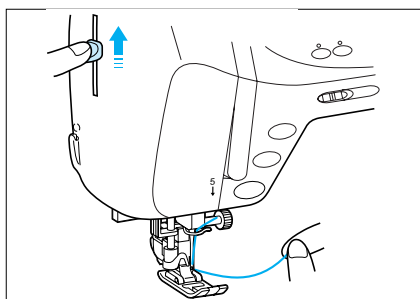

11. Pull the thread towards the rear to finish the upper threading.

⚠ CAUTION

The needle threader lever can only be used with home sewing machine needles size 75/11-100/16. Check the table on page 26 for appropriate needle and thread combinations. Note that, if you are using transparent nylon mono-filament thread, only needles in the range of 90/14-100/16 can be used.

12. Pass the thread underneath the presser foot and pull it out from the rear of the machine by about 50 mm(2").

* You do not need to pull the bobbin thread up before you start sewing.

Note

Always raise the presser foot before removing the upper thread from the machine or damage may occur to the tension unit.

⚠ CAUTION

The needle threader lever can not be used to thread the needle when you are using decorative threads or specialty needles like the twin needle and wing needle. When using those types of threads or needles, thread the eye of the needle manually. Make sure the main power switch is OFF when threading the needle manually.

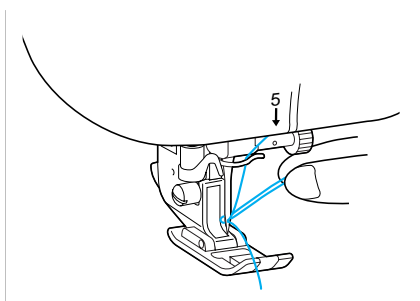

Using the extra spool pin and the net

Extra spool pin

Use when sewing with metallic thread.

1. Insert the extra spool pin onto the end of the bobbin winder shaft.
2. Install the spool felt and the thread spool in that order, and then thread the upper thread.

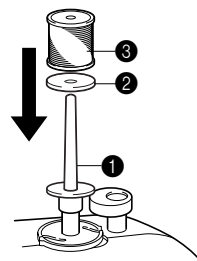

- 1 Insert the extra spool pin into the end of the bobbin winder shaft
- 2 Spool felt
- 3 Thread spool

* When setting the thread spool, set it so that the thread winds off from the front of the spool.

* If using metallic thread, we recommend that you use a 90/14 home sewing machine needle or contact your dealer for special needles made for decorative and metallic threads.

Note

This method keeps the thread from twisting as it comes off the spool pin.

Net

If using special threads which wind quickly off the thread spool, attach a net to the spool before using.

- * Cut the net to match the size of the spool.

- 1 Net
- 2 Thread spool
- 3 Spool pin
- 4 Spool cap

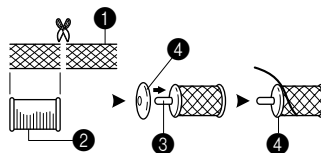

Depending on the model, the net may be available as an optional part.

Needle	Thread (cotton)
65/9	#30, 50, 60
75/11	#30
90/14	#30
100/16	#20

Note

The auto-threading device cannot be used with the combinations shown at left.

Transparent nylon thread can be used regardless of the chart providing needle used is 90/14 to 100/16.

STARTING AND STOPPING SEWING

“START/STOP” button

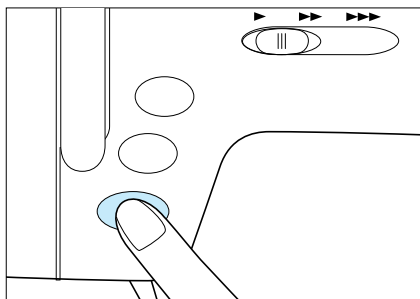

1. Place the fabric under the presser foot, lower the presser foot, and then press the “START/STOP” button. The sewing machine starts sewing.
 - * Slide the sewing speed controller to adjust the sewing speed.
 - * Hold down the “START/STOP” button to sew at a slow speed.
2. Press the “START/STOP” button to stop the sewing machine.

Foot controller

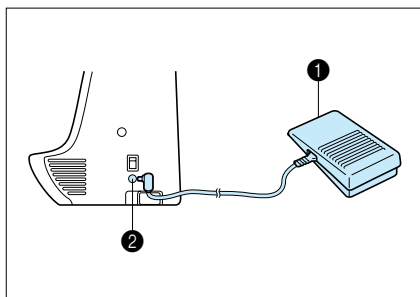

⚠ CAUTION

Do not allow fabric pieces and dust to collect in the foot controller. Doing so could cause a fire or an electric shock.

1. With the sewing machine turned off, insert the foot controller plug into its jack on the sewing machine.

- ① Foot controller
- ② Foot controller jack

2. Turn on the sewing machine, then slowly depress the foot controller to start sewing.

- * The speed set using the sewing speed controller is the foot controller's maximum sewing speed.

3. Release the foot controller to stop the sewing machine.

- * When the foot controller is being used, the “START/STOP” button has no effect on the sewing.

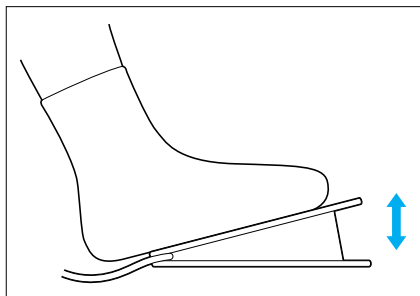

Note (For U.S.A. only)

Foot controller: Model N5V

This foot controller can be used on this machine model PC-2800.

SELECTING A STITCH PATTERN

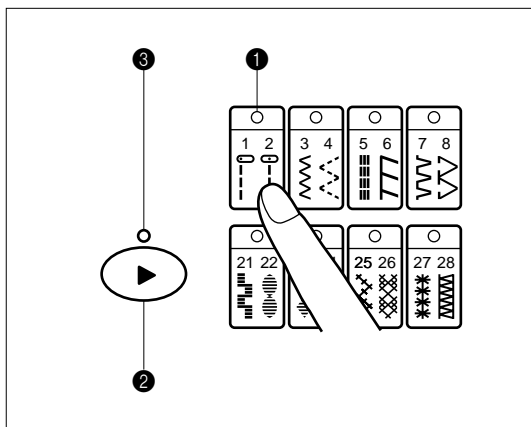

This sewing machine is equipped with 40 built-in utility and decorative stitches.

Press the stitch selection key that shows the stitch you want to sew. The LED lamp will light up. If the stitch you want to sew is shown on the right side of the stitch selection key, touch the stitch pattern switch key. The LED lamp will light up.

- * When the LED lamp on the stitch pattern switch key is lit, the stitch pattern on the right side is selected. When the LED lamp on the stitch pattern switch key is turned off, the stitch pattern on the left side is selected.
- * You must press the stitch pattern switch key to change it. It will not change automatically when another key is pressed (except when the main power switch is turned OFF). Always check the stitch pattern switch key's LED lamp when you make a stitch selection.

- ① A lit LED lamp shows the selection.
- ② Stitch pattern switch key
- ③ If the lamp is lit the right side is selected; if the lamp is turned off the left side is selected.

Note

- Before changing the stitch, press the "NEEDLE POSITION" button to raise the needle.
- When the main power switch is turned ON, the stitch pattern switch key's LED lamp will turn off, and the straight stitch (left) is automatically selected.

Quick adjustment reference chart for stitch width and stitch length

STITCH		Stitch width [mm (in.)]		Stitch length [mm (in.)]		STITCH		Stitch width [mm (in.)]		Stitch length [mm (in.)]		
		Auto	Manual	Auto	Manual			Auto	Manual	Auto	Manual	
Straight stitch (Left)		0.0 (0)	0.0–7.0 (0–1/4)	2.5 (3/32)	0.2–5.0 (1/64–3/16)	Satin stitch		7.0 (1/4)	2.5–7.0 (3/32–1/4)	0.4 (1/64)	0.1–1.0 (1/64–1/16)	
	Straight stitch (Middle)		—	—	2.5 (3/32)		0.2–5.0 (1/64–3/16)		7.0 (1/4)	2.5–7.0 (3/32–1/4)	0.4 (1/64)	0.1–1.0 (1/64–1/16)
Zigzag stitch			3.5 (1/8)	0.0–7.0 (0–1/4)	1.4 (1/16)		0.0–4.0 (0–3/16)		7.0 (1/4)	2.5–7.0 (3/32–1/4)	0.4 (1/64)	0.1–1.0 (1/64–1/16)
	3 step elastic zigzag		5.0 (3/16)	1.5–7.0 (1/16–1/4)	1.0 (1/16)		0.2–4.0 (1/64–3/16)		7.0 (1/4)	2.5–7.0 (3/32–1/4)	0.4 (1/64)	0.1–1.0 (1/64–1/16)
Triple stretch stitch		0.0 (0)	0.0–7.0 (0–1/4)	2.5 (3/32)	1.5–4.0 (1/16–3/16)	Cross stitch		6.0 (15/64)	0.0–7.0 (0–1/4)	2.5 (3/32)	0.2–4.0 (1/64–3/16)	
	Overcasting stitch		5.0 (3/16)	0.0–7.0 (0–1/4)	2.5 (3/32)		1.0–4.0 (1/16–3/16)		6.0 (15/64)	0.0–7.0 (0–1/4)	2.5 (3/32)	0.2–4.0 (1/64–3/16)
Blind hem stitch			3.5 (1/8)	2.5–5.0 (3/32–3/16)	2.0 (1/16)	1.0–4.0 (1/16–3/16)	Hemstitching		6.0 (15/64)	1.5–7.0 (1/16–1/4)	2.5 (3/32)	1.5–4.0 (1/16–3/16)
		Blind hem stitch stretch		5.0 (3/16)	2.5–5.0 (3/32–3/16)	2.5 (3/32)		1.0–4.0 (1/16–3/16)		5.0 (3/16)	1.5–7.0 (1/16–1/4)	4.0 (3/16)
Rounded buttonhole			0.0 (0)	+3 – –3	2.0 (1/16)	1.0–3.5 (1/16–1/8)			3.5 (1/8)	1.5–7.0 (1/16–1/4)	3.0 (1/8)	1.6–4.0 (1/16–3/16)
	Squared buttonhole		5.0 (3/16)	3.0–5.0 (1/8–3/16)	0.4 (1/64)	0.3–1.0 (1/64–1/16)		Decorative stitch		5.0 (3/16)	3.0–7.0 (1/8–1/4)	3.5 (1/8)
Stretch buttonhole			5.0 (3/16)	3.0–5.0 (1/8–3/16)	0.4 (1/64)	0.2–1.0 (1/64–1/16)			4.0 (3/16)	0.0–7.0 (0–1/4)	2.5 (3/32)	1.0–4.0 (1/16–3/16)
	Heirloom buttonhole		6.0 (15/64)	3.0–6.0 (1/8–15/64)	1.0 (1/16)	0.5–2.0 (1/32–1/64)			5.0 (3/16)	0.0–7.0 (0–1/4)	1.2 (1/16)	0.2–4.0 (1/64–3/16)
Keyhole buttonhole			6.0 (15/64)	3.0–6.0 (1/8–15/64)	1.5 (1/16)	1.0–3.0 (1/16–1/8)			0.0 (0)	0.0–7.0 (0–1/4)	2.5 (3/32)	1.0–4.0 (1/16–3/16)
	Blanket stitch		7.0 (1/4)	3.0–7.0 (1/8–1/4)	0.5 (1/32)	0.3–1.0 (1/64–1/16)			5.0 (3/16)	1.5–7.0 (1/16–1/4)	1.0 (1/16)	0.2–4.0 (1/64–3/16)
Feather stitch			3.5 (1/8)	2.5–7.0 (3/32–1/4)	2.5 (3/32)	1.6–4.0 (1/16–3/16)	Decorative stitch			7.0 (1/4)	0.0–7.0 (0–1/4)	2.5 (3/32)
	Fagoting cross stitch		5.0 (3/16)	0.0–7.0 (0–1/4)	2.5 (3/32)	1.0–4.0 (1/16–3/16)				7.0 (1/4)	0.0–7.0 (0–1/4)	2.5 (3/32)
Scallop stitch			5.0 (3/16)	2.5–7.0 (3/32–1/4)	2.5 (3/32)	1.0–4.0 (1/16–3/16)				7.0 (1/4)	0.0–7.0 (0–1/4)	2.5 (3/32)
	Eyelet		5.0 (3/16)	2.5–7.0 (3/32–1/4)	0.4 (1/64)	0.1–1.0 (1/64–1/16)				7.0 (1/4)	0.0–7.0 (0–1/4)	2.5 (3/32)
Eyelet			7.0 (1/4)	7.0, 6.0, 5.0 (1/4, 15/64, 3/16)	—	—				7.0 (1/4)	0.0–7.0 (0–1/4)	2.5 (3/32)
	Eyelet		7.0 (1/4)	7.0, 6.0, 5.0 (1/4, 15/64, 3/16)	—	—			7.0 (1/4)	0.0–7.0 (0–1/4)	2.5 (3/32)	0.2–4.0 (1/64–3/16)

—: Not adjustable

THREAD TENSION

Correct upper thread tension

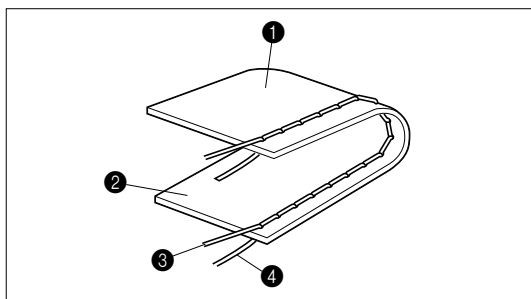
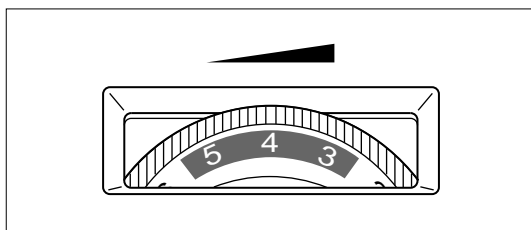

The thread tension is normally set on “4” for general sewing applications. (Refer to the FABRIC/THREAD/NEEDLE COMBINATION CHART on page 26.)

However, the thread tension dial can be used to adjust the tension of the upper thread in the following cases.

- * when using specialty threads or sewing on special fabric
- * when sewing gathers, shirring or shell tucks
- * when these settings do not give the desired result

The upper thread and the bobbin thread should cross at about the center of the fabric. If the thread tension is incorrectly set, flat attractive seams will not be sewn or the fabric will pucker.

- ❶ Wrong side
- ❷ Right side
- ❸ Upper thread
- ❹ Bobbin thread

Loosening the upper thread tension

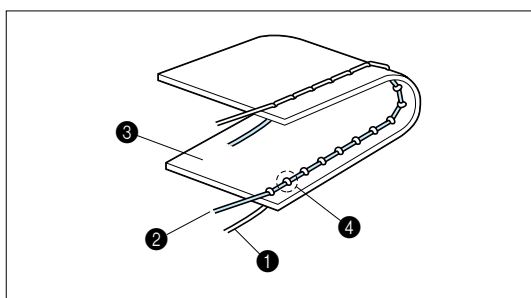
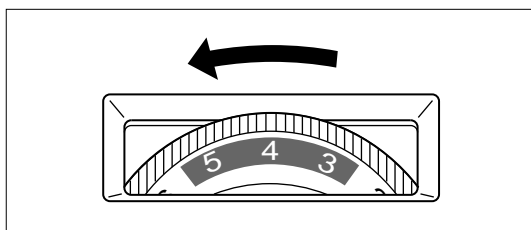

Turn the thread tension dial to the left to loosen the upper thread tension.

- ❶ Bobbin thread
- ❷ Upper thread
- ❸ Right side
- ❹ If the upper thread tension is too strong, locks appear on the right side of the fabric.

Tightening the upper thread tension

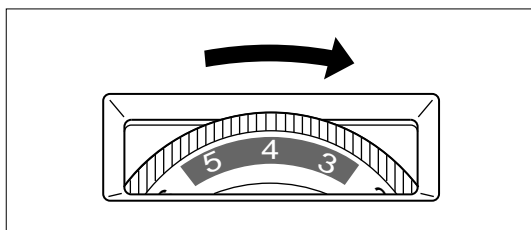

Turn the thread tension dial to the right to tighten the upper thread tension.

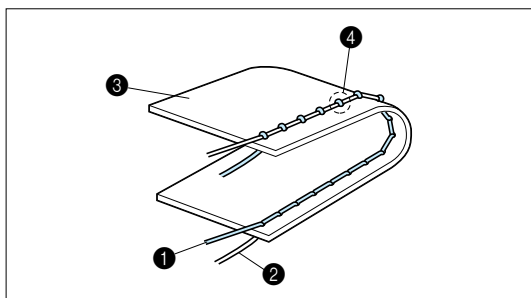

- ① Upper thread
- ② Bobbin thread
- ③ Wrong side
- ④ If the upper thread tension is too weak, locks appear on the wrong side of the fabric.

PRESSER FOOT

Changing the presser foot

⚠ CAUTION

- Always turn off the power before changing the presser foot. If the power is on and the “Start/Stop” button or another button is pressed, the machine will start and may cause injury.
- Always use the correct presser foot for the selected stitch pattern. If the wrong presser foot is used, the needle may strike the presser foot and bend or break, and may cause injury.
- Only use presser feet for this machine. Using other presser feet may lead to accident or injury.

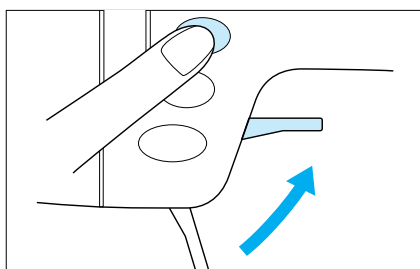

1. Press the “NEEDLE POSITION” button to raise the needle, and then turn off the power.
2. Raise the presser foot lever.

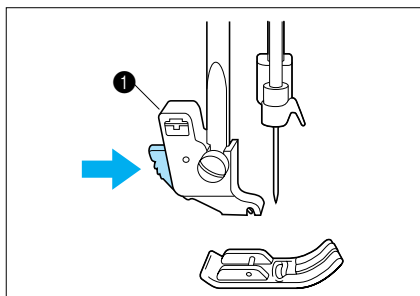

3. Press the black button at the back of the presser foot holder, and remove the presser foot.

❶ Presser foot holder

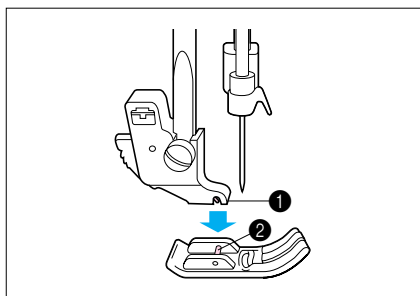

4. Place the presser foot pin directly below the holder-end and lower the presser foot lever to attach the presser foot.

- ❶ Holder-end
- ❷ Foot pin

Removing the presser foot holder (while cleaning, etc.)

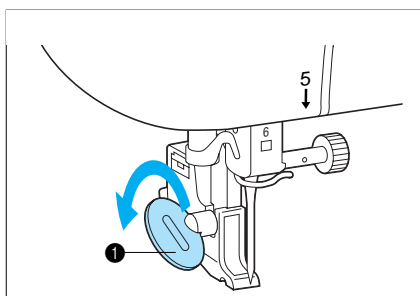

Use the included disc-shaped screwdriver to loosen the screw of the presser foot holder, and remove the presser foot holder.

Note

When reattaching the presser foot holder, first attach the presser foot to the presser foot holder. Then, lower the presser foot lever, install the presser foot holder and securely tighten the presser foot holder screw. The thread tension may be inaccurate if the presser foot holder is incorrectly attached.

- ❶ Disc-shaped screwdriver

ATTACHING THE OPTIONAL WALKING FOOT

This foot is very useful for sewing materials such as vinyl cloth, synthetic leather, thin leather, etc. These materials are difficult to feed when sewing but this foot can prevent such materials from crumpling, slipping or sticking to presser foot thanks to even feeding of upper and lower materials.

- You can use walking foot for sewing STRAIGHT STITCH ($\begin{matrix} 1 \\ | \\ \text{---} \\ | \\ 1 \end{matrix} \cdot \begin{matrix} 2 \\ | \\ \text{---} \\ | \\ 1 \end{matrix}$) and ZIGZAG STITCH ($\begin{matrix} 3 \\ \diagup \\ \text{---} \\ \diagdown \\ 1 \end{matrix}$).
- Reverse stitches can not be sewn with the walking foot.

Note

You can not use this foot for sewing other patterns.

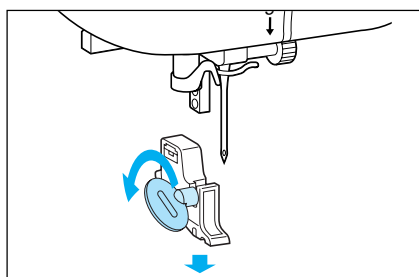

1. Push the "NEEDLE POSITION" button to raise the needle, and then turn off the power.

2. Raise the presser foot lever and remove the presser foot.

3. Use the included disc-shaped screwdriver to loosen the screw of the presser foot holder, and remove the presser foot holder.

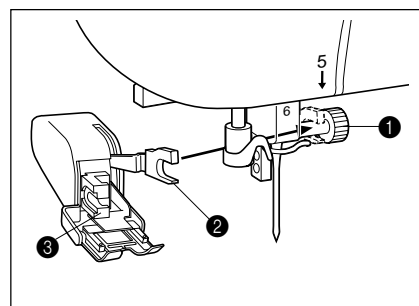

4. Set the operation lever of the walking foot so that the fork surrounds the needle clamp screw, and set the walking foot shank on the presser foot shaft.

- ① Needle clamp screw
- ② Operating lever
- ③ Walking foot shank

5. Lower the presser foot lever, insert the presser foot holder, and tighten the screw securely with the disc-shaped screwdriver.

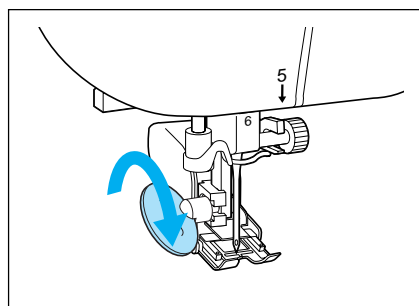

⚠ CAUTION

- Use the disc-shaped screwdriver to tighten the screw securely. If the screw is loose, the needle may strike the presser foot and cause injury.
- Be sure to turn the balance wheel toward the front of the machine to check that the needle does not strike the presser foot. If the needle strikes the presser foot, injury may result.

CAUTION

When sewing with the walking foot, sew at medium to low speeds.

FEED DOG

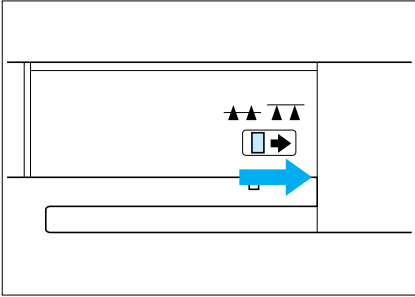

With the accessory compartment off of the machine, the feed dog position switch can be seen on the base of the sewing machine. Sliding the switch to the right will lower the feed dog, for example during button sewing.

If you wish to continue sewing normally, slide the lever to the left in order to raise the feed dog.

The feed dog cannot be raised if the balance wheel does not turn, even if the lever is slid to the left.

NEEDLE

Checking the needle

⚠ CAUTION

- Turn the main power switch to OFF before changing the needle. If the main power is left on and the “START/STOP” button or another operation button is pressed accidentally, the machine will start and injury may result.
- Use only sewing machine needles for home use. Other needles may bend or break and cause injury.
- Never sew with a bent needle. A bent needle will easily break and cause injury.

To Check the Needle Correctly:

To check the needle, place the flat side of the needle on a flat surface. Check the needle from the top and the sides. Throw away any bent needles.

- 1 Parallel space
- 2 Level surface (bobbin cover, glass, etc.)

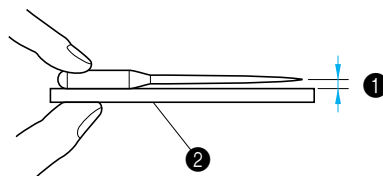

* Place a level surface under the needle

Installing the needle securely

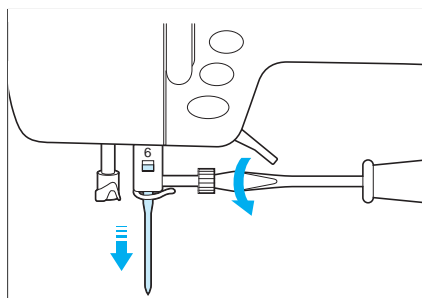

1. Push the “NEEDLE POSITION” button to raise the needle, and then turn off the power.
2. Lower the presser foot.
3. Loosen the needle clamp screw with a screwdriver.
4. Pull out the needle.

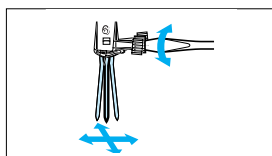

CAUTION

Do not loosen or tighten the needle clamp screw with a strong force, otherwise it may be damaged

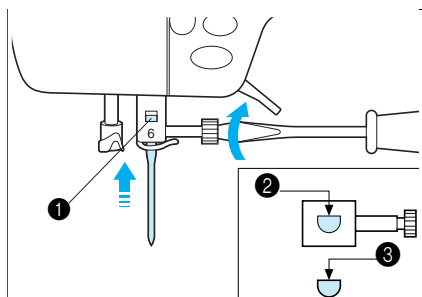

5. With the flat side of the needle facing the back, insert the new needle all the way to the top of the needle stopper (viewing window) in the needle clamp. Use a screwdriver to securely tighten the needle clamp screw.

- 1 Needle stopper
- 2 Hole for setting needle
- 3 Flat side of needle

⚠ CAUTION

Be sure to push in the needle until it touches the stopper, and securely tighten the needle clamp screw with a screwdriver. If the needle is not completely inserted or the needle clamp screw is loose, the needle may break or the machine may be damaged.

FABRIC/THREAD/NEEDLE COMBINATION CHART

About the Needle

The sewing machine needle is probably the most important part of the sewing machine. Choosing the proper needle for your sewing project will result in a beautiful finish and fewer problems. Below are some things to keep in mind about needles.

- The smaller the needle number, the smaller the needle. As the numbers increase, the needles get thicker.
- Use fine needles with lightweight fabrics, and thicker needles with heavyweight fabrics.
- To avoid skipped stitches, use ball point needle (golden colored) 90/14 with stretch fabrics.
- To avoid skipped stitches when sewing decorative stitches, we recommend using the ballpoint needle (golden colored).
- A home sewing machine needle 75/11 is inserted in the sewing machine.

Fabric		Thread		Size of needle
		Type	Size	
Medium weight fabric	Broadcloth	Cotton	60 - 80	75/11 - 90/14
	Taffeta	Synthetic mercerized	60 - 80	
	Flannel, Gabardine	Silk or silk finished	50 - 80	
Lightweight fabric	Lawn, Batiste	Cotton	60 - 80	65/9 - 75/11
	Georgette	Synthetic mercerized	60 - 80	
	Challis, Satin	Silk	50 - 80	
Heavyweight fabric	Denim	Cotton	30 - 50	90/14 - 100/16
	Corduroy	Synthetic mercerized	50	
	Tweed	Silk	50	
Stretch fabric	Jersey	Thread for knits	50 - 60	Ball point needle (golden colored) 75/11 - 90/14
	Tricot			
Easily frayed fabric		Cotton	50-80	65/9-90/14
		Synthetic mercerized	50-80	
		Silk	50-80	
For top stitching		Synthetic mercerized	30	90/14 - 100/16
		Silk	30	

* For transparent nylon thread, always use needle 90/14 - 100/16.

* The same thread is usually used for the bobbin thread and upper threading.

CAUTION

Be sure to follow the needle, thread, and fabric combinations listed in the table. Using an improper combination, especially a heavyweight fabric (i.e., denim) with a small needle (i.e., 65/9 - 75/11), may cause the needle to bend or break, and lead to injury. Also, the seam may be uneven, the fabric may pucker, or the machine may skip stitches.

TRIAL SEWING

Sewing using a utility stitch

⚠ CAUTION

- To avoid injury, pay special attention to the needle while the machine is in operation. Keep your hands away from moving parts while the machine is in operation.
- Do not stretch or pull the fabric during sewing. Doing so may lead to injury.
- Do not use bent or broken needles. Doing so may lead to injury.
- Take care that the needle does not strike basting pins or other objects during sewing. Otherwise, the needle may break and cause injury.
- If stitches become bunched, lengthen the stitch length setting before continuing sewing. Otherwise, the needle may break and cause injury.

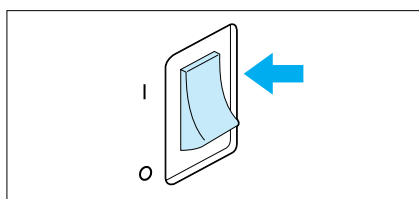
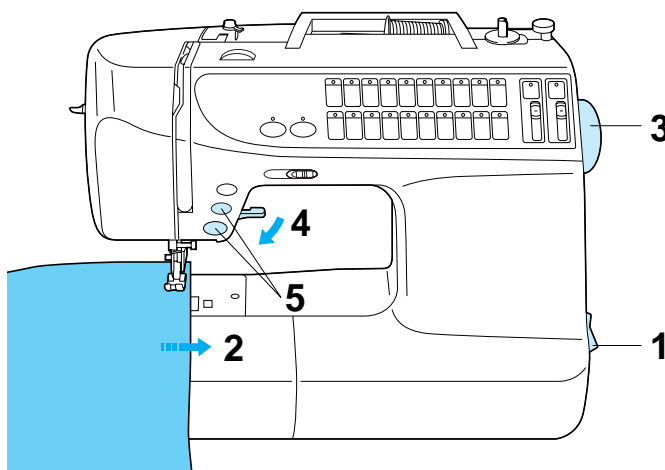

1. Turn on the sewing machine. The straight stitch (left) is selected.

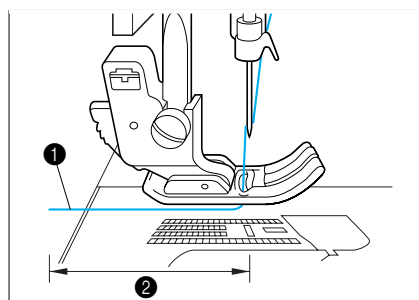

2. Install the correct presser foot. Place the fabric under the presser foot, then pull out about 5 cm (2") of the upper thread and pass it under the presser foot toward the rear of the machine.

- ① Upper thread
- ② 5 cm (2")

⚠ CAUTION

Always use the correct presser foot. If the wrong presser foot is used, the needle may strike the presser foot and bend or break, resulting in injury.

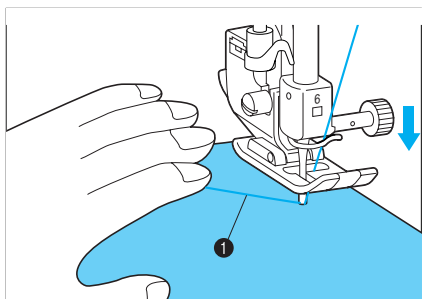

3. While pressing down on the thread and the fabric with your left hand, turn the balance wheel with your right hand to move the needle to the sewing start position.

1 Thread

- * You can begin sewing without drawing up the bobbin thread.

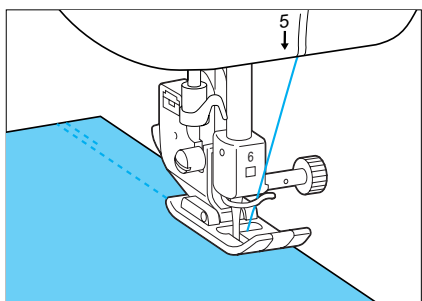

4. Lower the presser foot. Press the "REVERSE STITCH" button to sew a few reverse stitches, and then press the "START/STOP" button. The machine will start sewing at a slow speed.

- * Reverse stitches are sewn while the "REVERSE STITCH" button is pressed.
- * The sewing speed cannot be adjusted while reverse stitches are sewn.

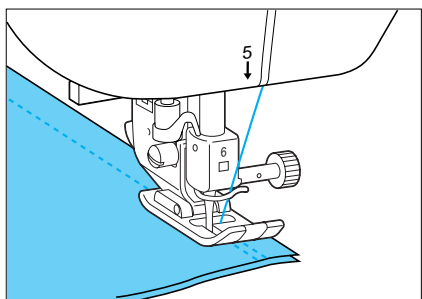

5. When sewing is completed, press the "REVERSE STITCH" button to sew a few reverse stitches.

- * If the needle stop position is set to the down position (the needle stop position switch key's LED lamp is lit), press the "NEEDLE POSITION" button to raise the needle.

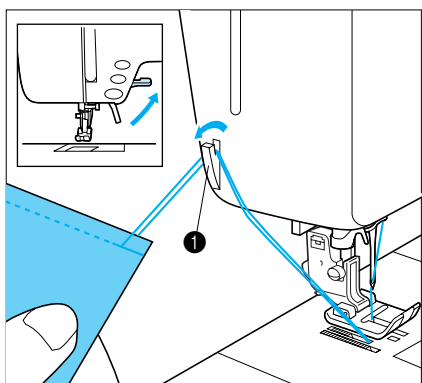

6. Raise the presser foot, remove the fabric and cut the thread.

1 Thread cutter

SETTING THE NEEDLE STOP DOWN POSITION

If you set the needle stop position to the down position when you select a stitch, the needle stops in the down position when sewing is finished. It is not necessary to press the "NEEDLE POSITION" button to lower the needle before rotating the fabric when continuously starting and stopping sewing.

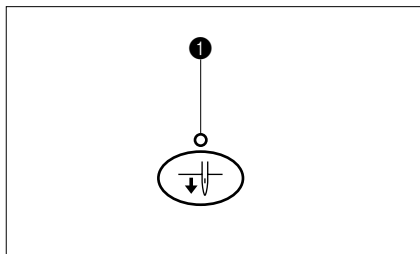

Touch the needle stop position switch key. The LED lamp above the key will light up. The needle stop position is set to the down position.

- ❶ **When the needle stop position switch key's LED lamp is lit, the needle stop position is set to the down position. When the needle stop position switch's LED lamp is turned off, the needle stop position is set to the up position.**

* You must press the needle stop position switch key to change it. It will not change automatically when another key is pressed (except when the main power switch is turned OFF).

Canceling the needle stop down position setting

Press the needle stop position switch key to turn off the LED lamp. The needle stop position will be set in the up position.

- * When the main power switch is turned to ON, the needle stop position switch key's LED lamp will turn off, and the needle stop position will be set in the up position.

STITCH WIDTH AND LENGTH

Generally suitable stitch width and length values are set automatically when a stitch is selected. If you prefer to use other values, follow the instructions below to change the values.

Adjusting the stitch width

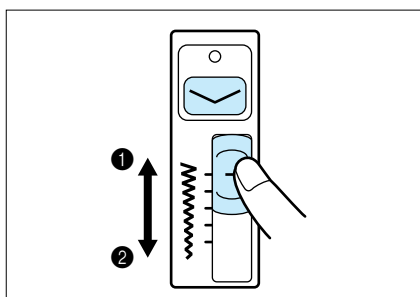

Press the stitch width manual change key. The LED lamp will light up. Move the stitch width adjustment lever up or down. Moving the lever up increases the stitch width, and moving the lever down decreases the stitch width.

- ① Up: Wider
- ② Down: Narrower

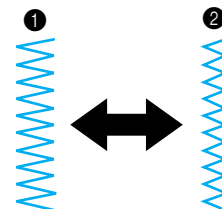

To return to the default settings (or to cancel the manual adjustments), press the stitch width manual change key to turn off the LED lamp.

Adjusting the stitch length

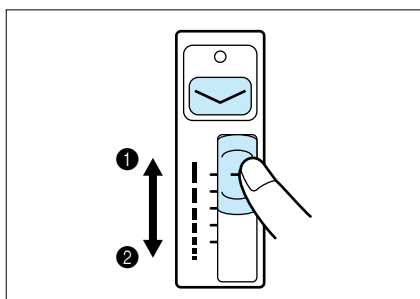

Press the stitch length manual change key. The LED lamp will light up. Move the stitch length adjustment lever up or down. Moving the lever up increases the stitch length, and moving the lever down decreases the stitch length.

- ① Up: Longer
- ② Down: Shorter

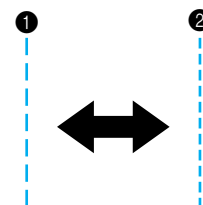

To return to the default settings (or to cancel the manual adjustments), press the stitch length manual change key to turn off the LED lamp.

In the following cases, the stitch width manual change key and the stitch length manual change key's LED lamps will be off, and the stitch width and length will return to the default values

- * When the main power switch is turned to ON.
- * When a different pattern is selected after the manual settings have been made.

⚠ CAUTION

If the stitches get bunched together, lengthen the stitch length and continue sewing. Do not continue sewing without lengthening the stitch length, otherwise the needle may break and cause injury.

USEFUL SKILLS

Sewing corners

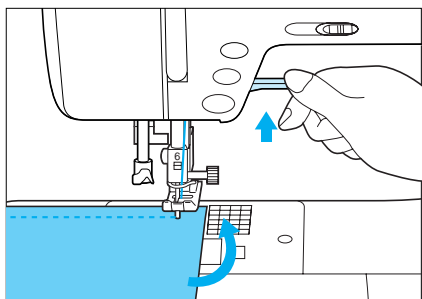

Stop the sewing machine with the needle in the fabric at the corner, then raise the presser foot and turn the fabric.

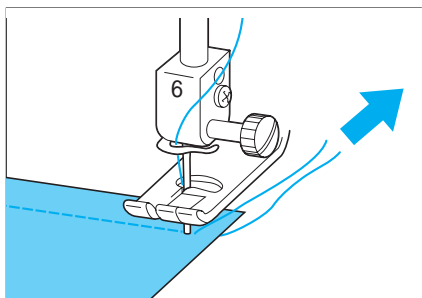

When sewing seams which are less than 5.0 mm (13/64" in width), baste the corner, then continue sewing while slowly changing the sewing direction and pulling the basting thread toward the rear of the machine.

Sewing curves

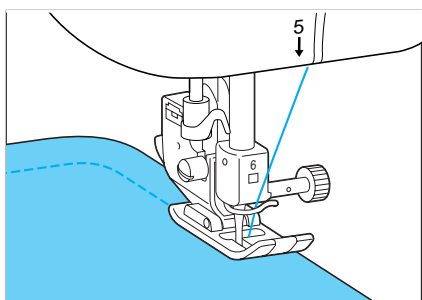

Sewing a curve with a straight stitch

Sew slowly while keeping the seam parallel to the fabric edge as you guide the fabric around the curve.

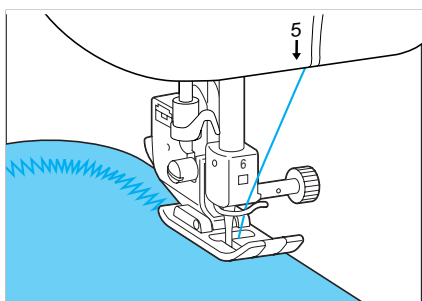

Sewing a curve with a zigzag stitch

Set the stitch length short in order to obtain a fine stitch. Sew slowly while keeping the seam parallel to the fabric edge as you guide the fabric around the curve.

* For sharp corners, temporarily stop sewing with the needle in the material, then raise the presser foot and carefully turn the fabric while keeping it level with the presser foot. Lower the presser foot and continue sewing.

Sewing heavyweight fabrics

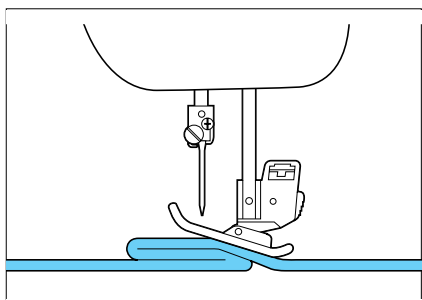

The sewing machine can sew fabrics up to 6 mm (1/4") thick. If the thickness of a seam causes sewing to occur on an angle, help guide the fabric by hand and sew on the downward slope.

⚠ CAUTION

Do not forcefully push fabrics more than 6 mm (1/4") thick through the sewing machine. This may cause the needle to break and cause injury.

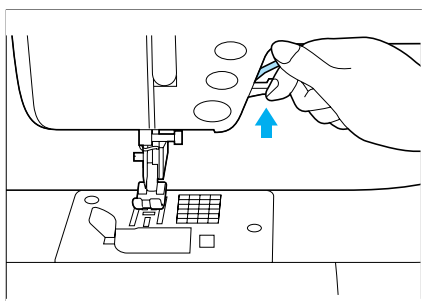

If the presser foot lever is in the up position, and you are sewing heavyweight or multiple layers of fabric which do not fit easily under the presser foot, raise the presser foot lever as high as possible by hand to bring the presser foot to its highest position. The fabric will now fit under the presser foot.

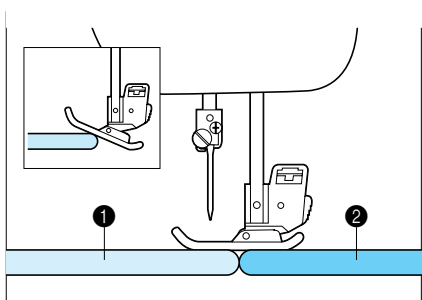

If the presser foot is not level and the fabric does not feed at the beginning of sewing (as shown at left), place a piece of fabric, paper or cardboard of the same thickness as the fabric being sewn under the back of the presser foot. The machine can then sew normally.

- ① Fabric
- ② Thick paper

Sewing lightweight fabrics

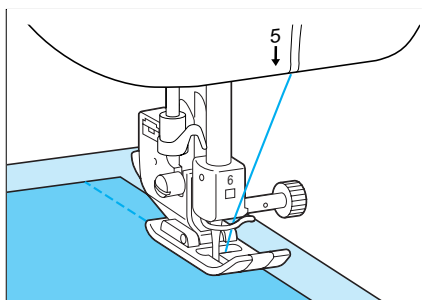

Place thin paper or stabilizer material under the fabric before sewing.

- * Use a straight stitch foot to eliminate any puckering. Remember to select the middle needle position. Additional adjustment of stitch length and tension may be necessary.

Using the needle plate

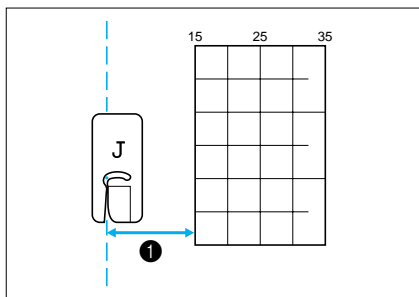

Align the edge of the fabric with a line on the needle plate to sew even seam allowances.

- ❶ 15 mm (9/16")

Free-arm sewing

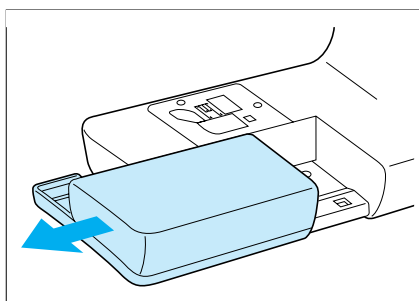

Free-arm sewing is convenient for sewing tubular areas such as pant hems and cuffs.

2. UTILITY STITCHES

STRAIGHT STITCHES

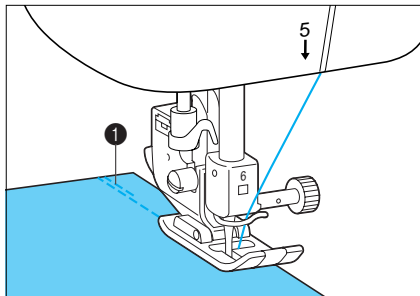

- 1: Straight stitch (left needle position) for normal sewing
- 2: Straight stitch (middle needle position) for normal sewing
- 5: Triple stretch stitch for reinforced sewing

1. Baste or pin the fabrics together.
2. Attach presser foot "J", sew three or four reverse stitches at the beginning, then start sewing.

① 3 to 4 reverse stitches

- * Place the fabric under presser foot allowing enough space from the edge for reverse sewing.

⚠ CAUTION

Be sure the needle does not strike a basting pin, or any other objects, during sewing. The thread could tangle or the needle could break, causing injury.

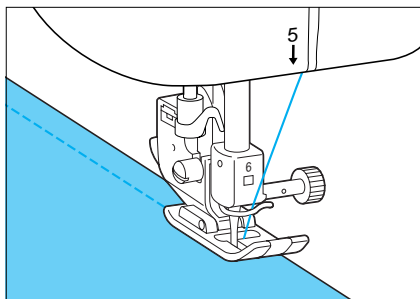

3. Sew at a slow speed as you approach the end of the sewing area, then press the "REVERSE STITCH" button to sew several reverse stitches and stop the machine.

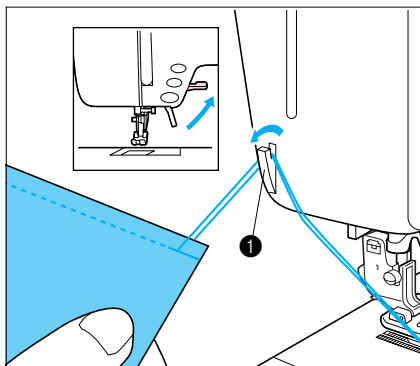

4. Raise the presser foot, remove the fabric and cut the thread.

① Thread cutter

Sewing stretch fabrics

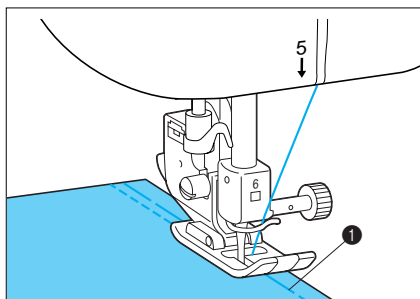

Baste the fabric pieces together, then sew along the basting without pulling the fabric.

* Do not pull the fabric while sewing.

1 Basting

Changing the stitch length

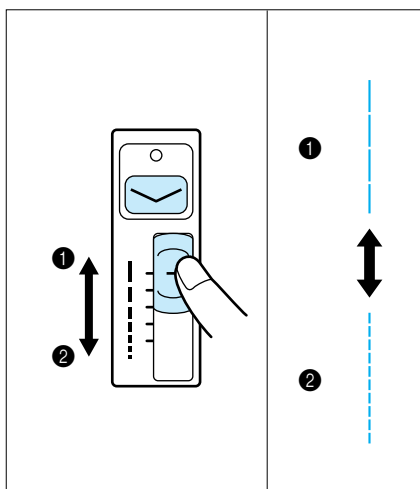

Press the stitch length manual change key to light up the LED lamp. Move the stitch length adjustment lever up or down to adjust the stitch length.

- 1 Up: Longer
- 2 Down: Shorter

* For thin material which is less than 1.0 mm (1/16") thick, the maximum stitch length will automatically be set to 4.0 mm (3/16") while sewing, even if the length setting is longer than 4.0 mm (3/16").

Changing the needle position (only “1” straight stitch (left) and “5” triple stretch stitch)

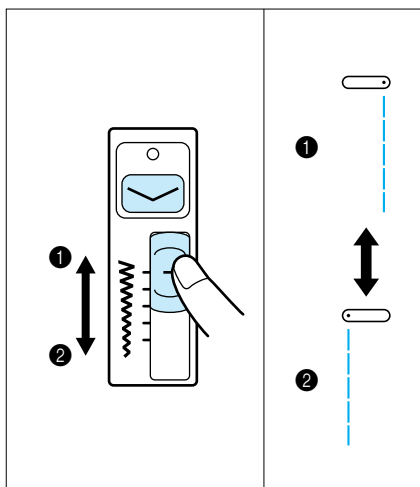

Press the stitch width manual change key to light up the LED lamp. Move the stitch width adjustment lever up or down to adjust the needle position.

- 1 Up: 7.0 mm (1/4") [right needle position]
- 2 Down: 0 mm (0") [left needle position]

* The needle position cannot be changed in the straight stitch (middle) setting.

ZIGZAG STITCHES



- 3: Zigzag stitch
- 4: Elastic zigzag stitch

Overcasting (using a zigzag stitch)

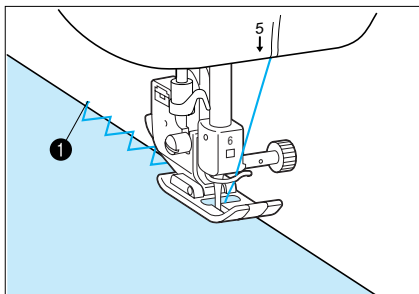

Sew the overcasting along the edge of the fabric so that the right-hand side needle drop point is over the edge of the fabric.

- 1 Needle drop position

Appliqué (using a zigzag stitch)

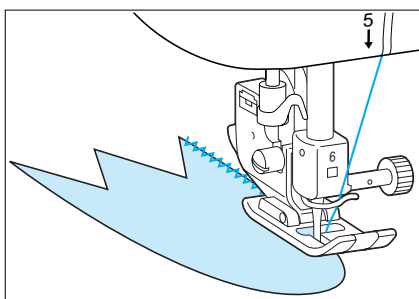

Attach the appliqué using a temporary spray adhesive or basting, then sew it.

* Sew a zigzag stitch while positioning the right hand needle drop point just outside the edge of the fabric.

Patchwork (for crazy quilts)

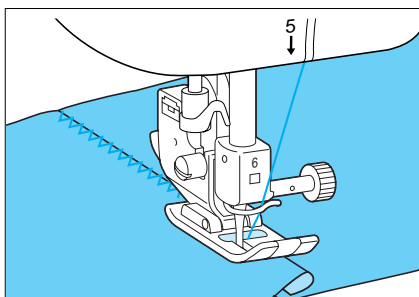

Turn back the desired width of fabric and position it over the lower fabric, then sew so that the stitch bridges both pieces of fabric.

Sewing curves (using a zigzag stitch)

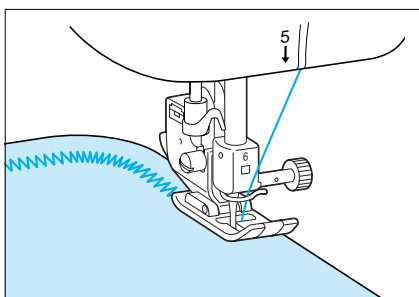

Shorten the stitch length setting to obtain a fine stitch. Sew slowly, keeping the seams parallel with the fabric edge as you guide the fabric around the curve.

OVERCASTING STITCHES

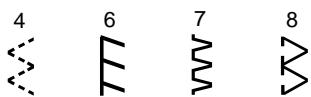

- 4: For sewing stretch fabrics
- 6: For sewing stretch fabrics
- 7: For sewing light and medium weight fabrics
- 8: For sewing heavyweight fabrics

Sewing using stitch ⁷ or ⁸

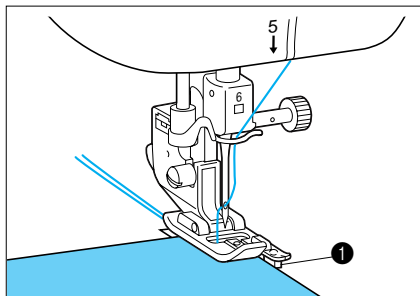

Sew the fabric with the fabric edge against the guide of presser foot "G".

1 Guide

! CAUTION

After the stitch width is adjusted, turn the balance wheel toward you by hand and check that the needle does not touch the presser foot. If the needle hits the presser foot the needle may break and cause injury.

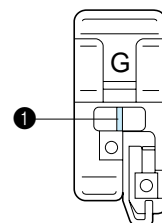

1 The needle should not touch

Sewing using stitch ⁴ or ⁶

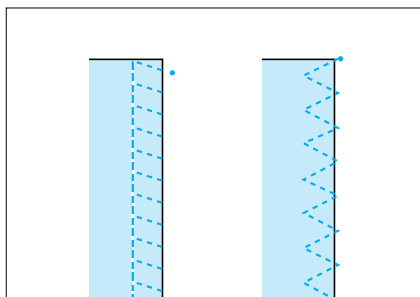

Attach presser foot "J" and let the needle drop slightly past the edge of the fabric before starting sewing.

OVERCASTING (WHEN USING THE OPTIONAL SIDE CUTTER)

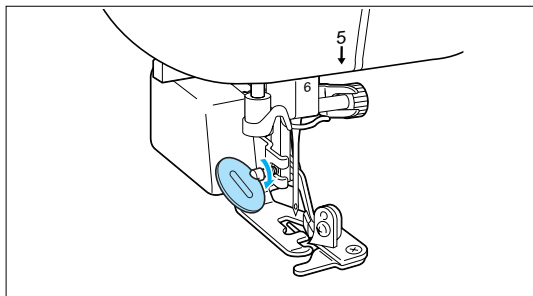
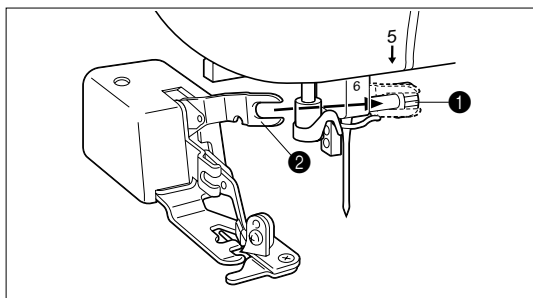
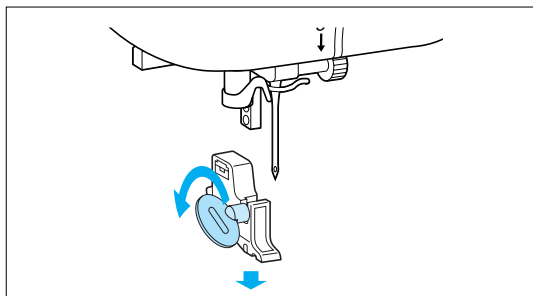
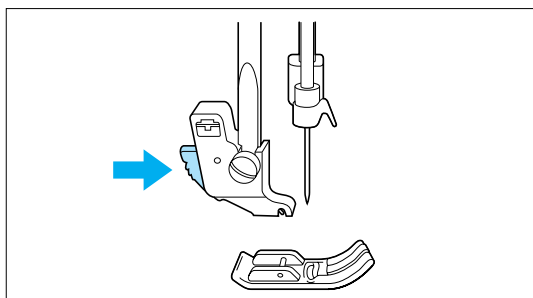
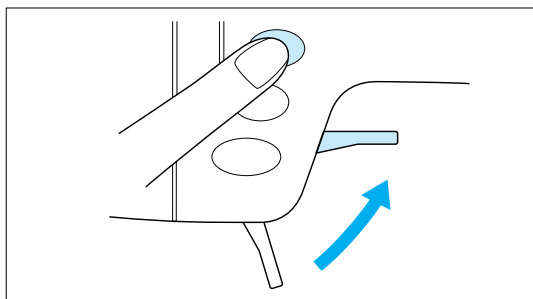

1: Normal sewing

7: Overcasting stitch for light and medium weight fabrics

8: Overcasting stitch for heavyweight fabrics

1. Push the "NEEDLE POSITION" button to raise the needle, then turn off the power.
2. Raise the presser foot lever.

3. Press the black button at the back of the presser foot holder, and remove the presser foot.

4. Use the included disc-shaped screwdriver to loosen the screw of the presser foot holder, and remove the presser foot holder.

5. Set the fork of the operating lever around the needle clamp screw.

① Needle clamp screw

② Operating lever

- * Make sure that the fork of the operating lever is set onto the screw firmly.

6. With the presser foot raised, align the presser foot holder screw hole directly with the notch in the side cutter, then insert the screw and lightly tighten it. Lower the presser foot lever and firmly tighten the screw.

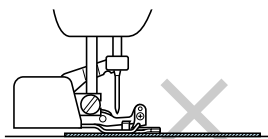
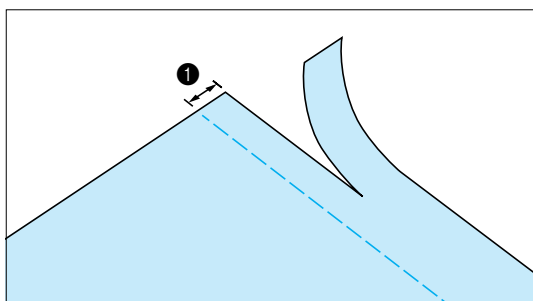
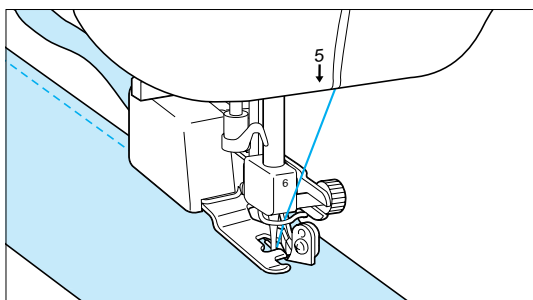
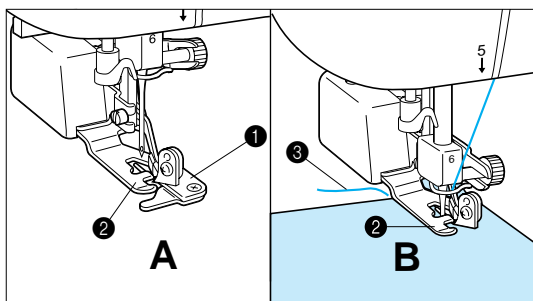
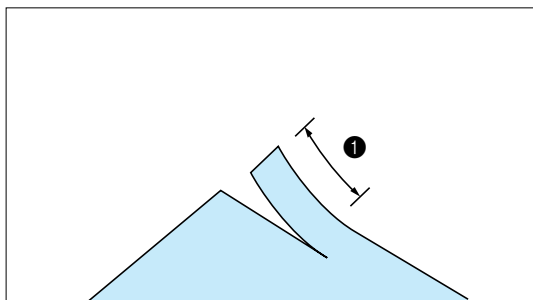

7. Make a cut of about 20 mm (3/4") in the fabric.

① 20 mm (3/4")

8. Place the fabric on foot as shown in figure B.
 - Right side of cut: on top of the guide plate
 - Left side of cut: underneath the presser foot

① Guide plate (lower knife)

② Presser foot

9. Thread the needle, then pull out a long section of the upper thread, pass it below the presser foot and pull it out in the fabric feed direction (see figure B).

② Presser foot

③ Upper thread

⚠ CAUTION

If the width has been adjusted, turn the balance wheel by hand and check that the needle does not touch the side cutter. If the needle hits the side cutter, the needle may break and cause injury.

When Sewing Straight Stitches only

The seam margin should be about 5 mm (3/16").

① Seam margin

- * Make sure you select a pattern for the side cutter.
- * Clean the side cutter after use, to avoid having dust and scraps of thread build up on it.
- * Add a small amount of oil as required to the cutting edge of the cutter.

Note

- The fabric will not be cut if the whole fabric is simply spread out underneath the presser foot guide plate. Set the fabric as explained in step 8, and then start sewing.
- Check that the needle is raised when the presser foot lever is raised.
- One layer of 13 oz. denim can be cut.



9
10

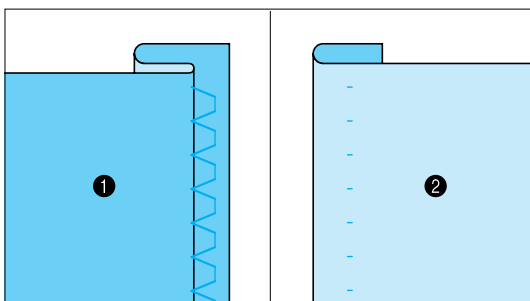
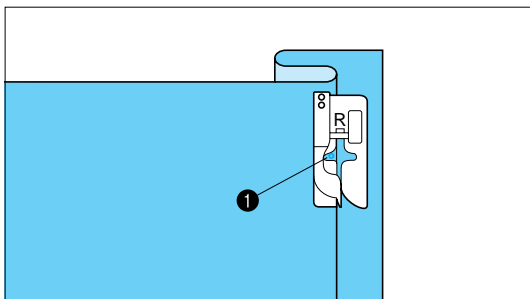
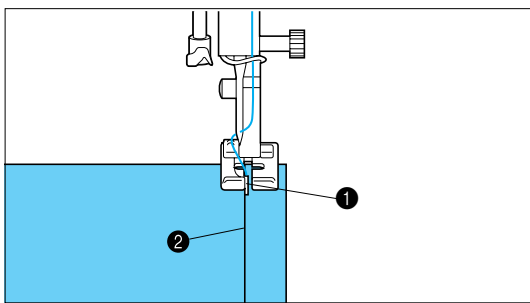
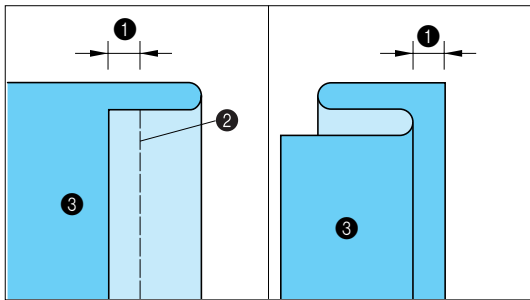

9: For woven fabrics
10: For stretch fabrics (jersey, knit fabrics)

1. Place the fabric wrong side up. Fold and baste the fabric as illustrated.

- 1 5 mm (3/16")
- 2 Basting stitches
- 3 Wrong side of the fabric

2. Attach blind hem stitch foot "R", and lower the presser foot. Position the fabric so the folded edge touches the guide of the presser foot.

- 1 Guide
- 2 Fold

3. Sew the fabric, keeping the folded edge in contact with the presser foot.

- 1 Needle position

4. Remove the basting stitches and turn over the fabric.

- 1 Wrong side of fabric
- 2 Right side of fabric

Blind hem stitches can not be sewn if the left needle drop point does not catch the fold. If the needle catches too much of the fold, the fabric can not be unfolded and the seam appearing on the right side of the fabric will be very large, leaving an unattractive finish. If you experience either of these cases, take the following steps to solve the problem.

Adjusting the needle drop point

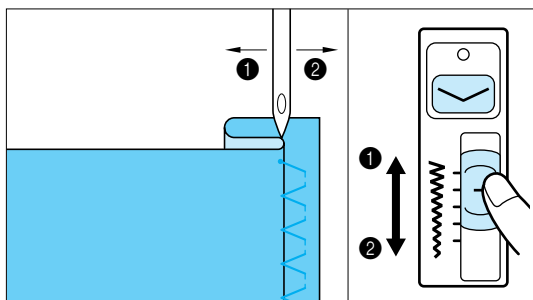

Press the stitch width manual change key to light up the LED lamp. Use the stitch width adjustment lever to adjust the needle drop point so that the needle slightly catches the fold of the hem.

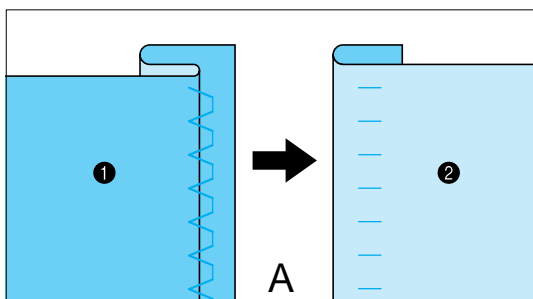

A- If the needle catches too much of the hem fold, move the stitch width adjustment lever down. This makes the stitch narrower to move the needle away from the fold.

- ❶ Wrong side of fabric
- ❷ Right side of fabric

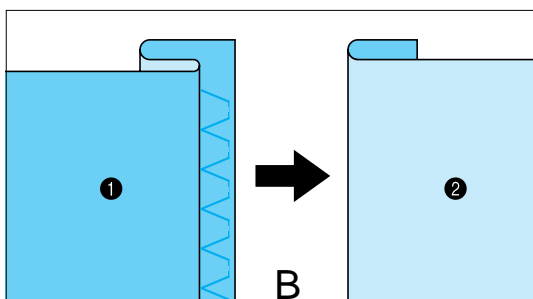

B- If the needle does not catch enough of the hem fold, move the stitch width adjustment lever up. This makes the stitch wider to move the needle closer onto the fold.

- ❶ Wrong side of fabric
- ❷ Right side of fabric

BUTTONHOLE STITCHING

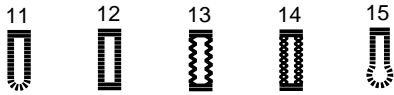

- 11: Rounded buttonhole on light to medium weight fabric *2
- 12: Squared buttonhole for light and medium weight fabrics *1
- 13: Squared heavy-duty buttonhole with reinforced bar tacks in medium to heavyweight fabrics *3
- 14: Stretch buttonhole with reinforced bar tacks in light to medium weight stretch fabrics, medium to heavyweight tightly woven fabrics, heavyweight fabrics with stretch fabrics *2
- 15: Keyhole buttonhole in heavyweight fabrics for larger flat buttons *2

- *1 For use on low stress or decorative applications
- *2 For use on average stress applications
- *3 For use on high stress or utility applications

Note

Before sewing a buttonhole on your project, practice on a scrap piece of the same type of fabric.

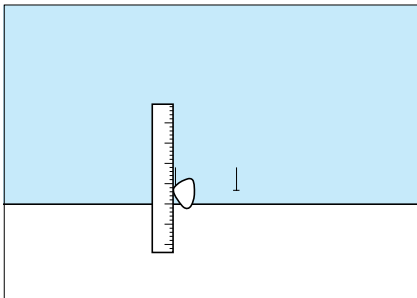

1. Mark the position and length of the buttonhole on the fabric.
- * The maximum buttonhole length is 30 mm (1-3/16") (diameter + thickness of the button)

- * Thick thread (#30) cannot be used with the "13" and "14" buttonhole styles.

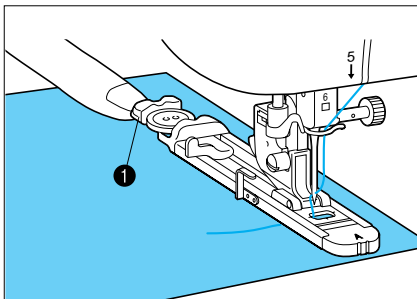

2. Attach buttonhole foot "A". Pull out the button holder plate on the presser foot, and insert the button that will be put through the buttonhole, then tighten the button holder plate around the button.
- * The size of the buttonhole is decided by the button holder plate holding the button.

1 Button holder plate

3. Align the presser foot with the mark on the fabric, and lower the presser foot lever.

- 1 Mark on the fabric
- 2 Mark on the presser foot

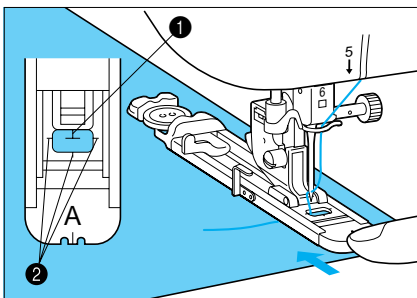

CAUTION

- Slide the outside frame of the buttonhole foot backward as far as possible as shown in the illustration, making sure that there is no gap behind the part of the foot marked "A". If the buttonhole foot is not slid back as far as possible, the buttonhole will not be sewn with the correct size.
- Pass the thread underneath the presser foot.

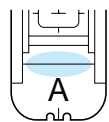

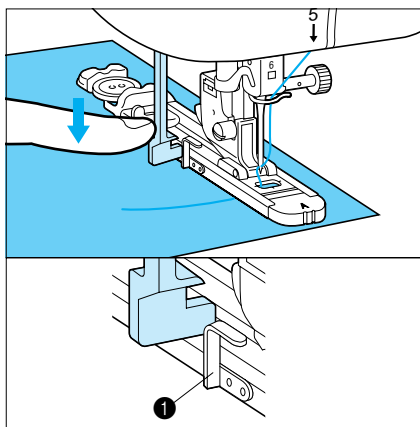

4. Lower the buttonhole lever so that it is positioned behind the metal bracket on the buttonhole foot.

❶ Metal bracket

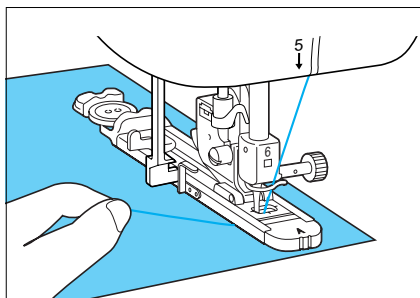

5. Gently hold the end of the upper thread, and then start sewing. Feed the fabric carefully by hand while the buttonhole is sewn. Once sewing is completed, the machine automatically sews reinforcement stitches, and then stops.

Note

If the fabric does not feed (for example, because it is too thick), increase the stitch length setting.

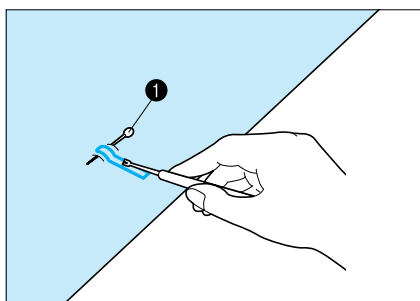

6. Insert a pin along the inside of one of the bar tacks, and then insert the seam ripper into the center of the buttonhole and cut towards the pin.

❶ Basting pin

⚠ CAUTION

When using the seam ripper to open the buttonhole, do not put your hand or finger in the path of the ripper. The ripper may slip and cause injury.

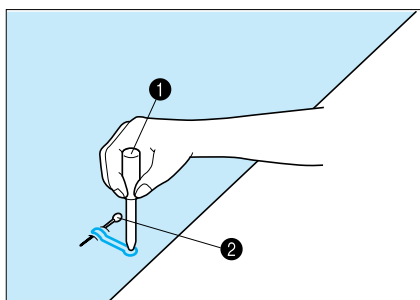

For Keyhole Buttonholes

Use the eyelet punch to make a hole in the rounded end of the buttonhole. Then insert a pin along the inside of one of the bar tacks, insert a seam ripper into the hole made with the eyelet punch, and cut towards the pin.

- ❶ Eyelet punch
❷ Basting pin

Buttonhole sewing order

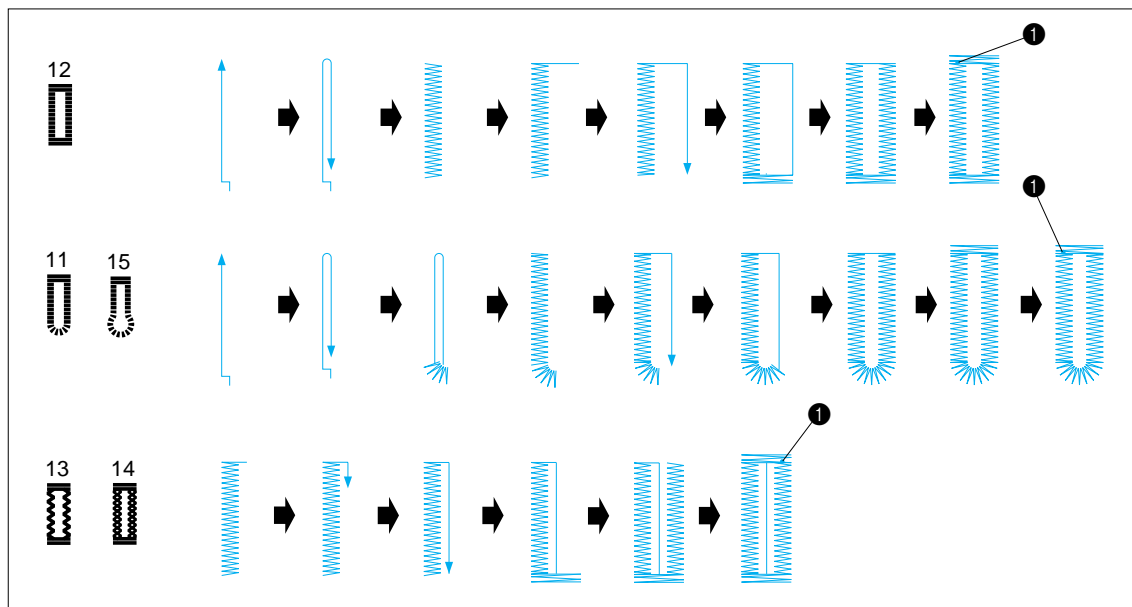

① Reinforcement stitch

Sewing stretch fabrics (“¹³” and “¹⁴”)

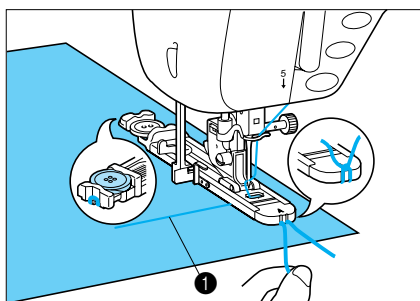

When sewing on stretch fabric with ¹³/₁₄, sew the buttonhole stitches over a gimp thread.

1. Hook the gimp thread onto the back of presser foot “A”. Insert the ends into the grooves at the front of the presser foot, and then temporarily tie it there.

① Upper thread

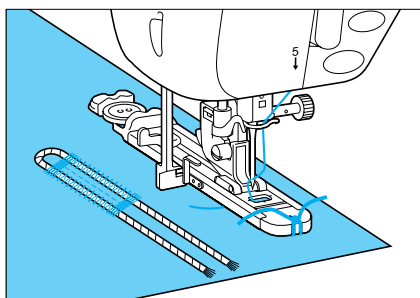

2. Lower the presser foot lever and start sewing.

* Set the stitch width to the width of the gimp thread.

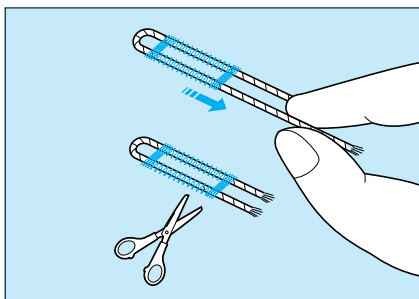

3. Once sewing is completed, gently pull the gimp thread to remove any slack, and trim off any excess.

* After using the seam ripper to cut open the threads over the buttonhole, trim off the threads.

Odd shaped buttons/Buttons that do not fit into the button holder plate

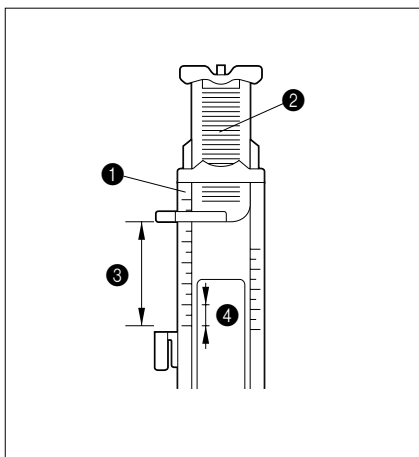

Use the markings on the presser foot scale to set the size of the buttonhole. One mark on the presser foot scale equals 5 mm (3/16").

Add together the button diameter and its thickness, and then set the plate at the calculated value

- ❶ Presser foot scale
- ❷ Button holder plate
- ❸ Completed measurement of diameter + thickness
- ❹ 5 mm (3/16")

Example:

For a button with a diameter of 15 mm (9/16"), a thickness of 10 mm (3/8"), the scale should be set at 25 mm (1").

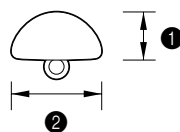

- ❶ 10 mm (3/8")
- ❷ 15 mm (9/16")

Changing the stitch length

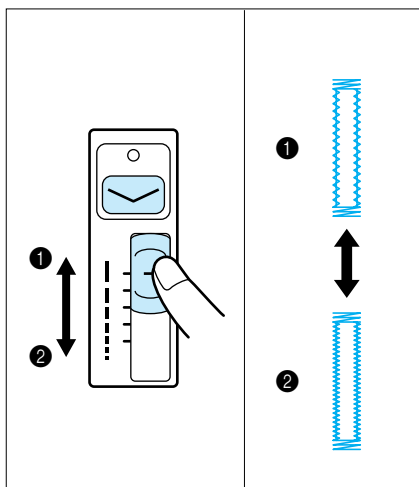

Press the stitch length manual change key to light up the LED lamp. Move the stitch length adjustment lever up or down to adjust the stitch length.

- ① Up: Longer
- ② Down: Shorter

* If the fabric does not feed (for example, because the fabric is too thick), move the stitch length adjustment lever up to increase the stitch length.

Changing the stitch width

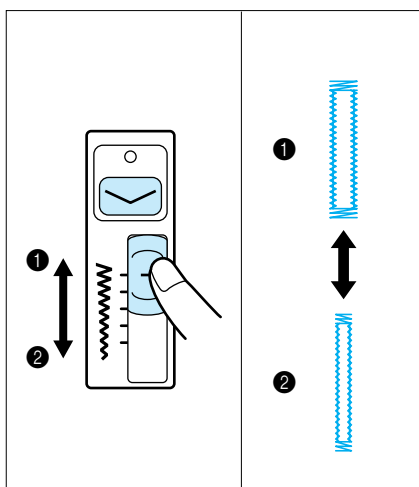

Press the stitch width manual change key to light up the LED lamp. Move the stitch width adjustment lever up or down to adjust the stitch width.

- ① Up: Wider
- ② Down: Narrower

* The maximum setting with the stitch width adjustment lever and the automatic stitch width setting is the same stitch width.



For sewing eyelets on belts, etc.

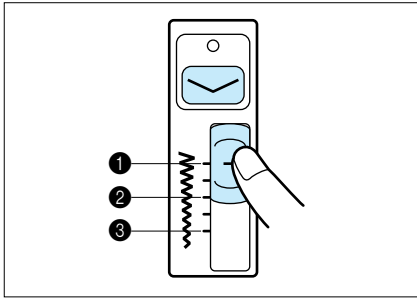

1. Press the stitch width manual change key to turn on the LED lamp.
2. Use the stitch width adjustment lever to select the eyelet size.

- ① Large
- ② Medium
- ③ Small

- * When the stitch width is at the default setting (the stitch width manual change key's LED lamp is blinking) the large eyelet will be sewn.
- * Stitch length can not be adjusted.

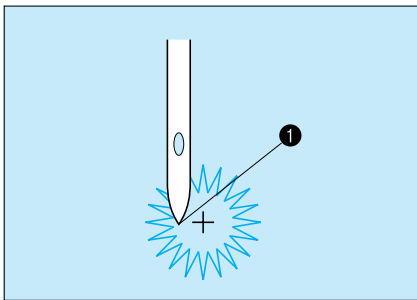

3. Attach monogramming foot "N", then turn the balance wheel to check the needle drop position. Lower the presser foot lever and start sewing. When sewing is finished, the machine sews reinforcement stitches and stops automatically.

① Needle drop position

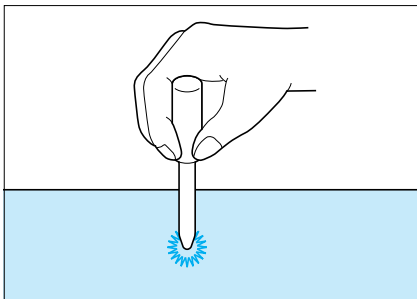

4. Use the eyelet punch to make a hole in the center of the stitching.

Size of eyelet (actual size)

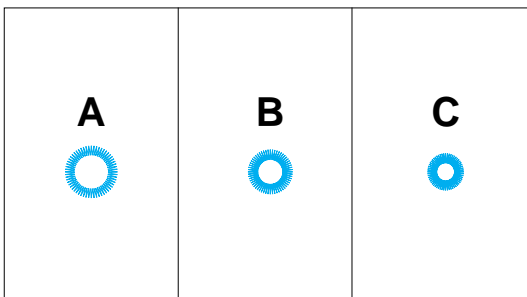

- A- Large: 7.0 mm (9/32")
- B- Medium: 6.0 mm (1/4")
- C- Small: 5.0 mm (13/64")



For attaching zippers

Centered zipper

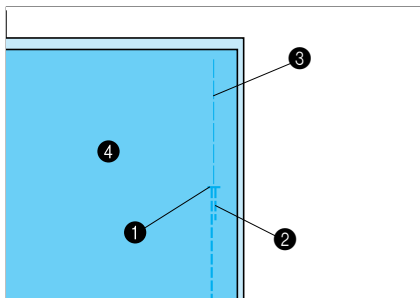

CAUTION

Make sure you sew using the middle needle position.

1. Attach presser foot "J" and sew straight stitches up to the zipper opening. Change to a basting stitch and sew to the top of the fabric.

- ① End of zipper opening
- ② Reverse stitches
- ③ Basting stitches
- ④ Wrong side of fabric

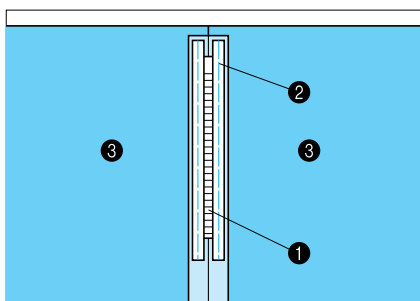

2. Press the seam allowance open and attach the zipper with a basting stitch in the middle of each side.

- ① Zipper
- ② Basting stitches
- ③ Wrong side of fabric

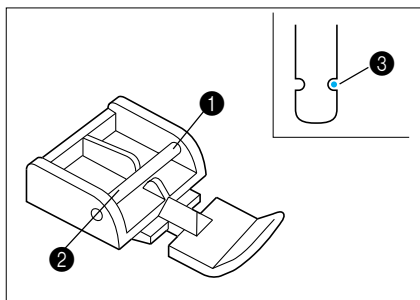

3. Remove presser foot "J". Align the right side of the pin in zipper foot "I" with the presser foot holder, and attach the zipper foot.

- ① Right
- ② Left
- ③ Needle drop position

⚠ CAUTION

When using zipper foot "I", make sure the straight stitch, middle needle position is selected. Turn the balance wheel to make sure the needle does not strike the presser foot. If another stitch is selected, the needle will strike the presser foot, causing the needle to break and possibly leading to injury.

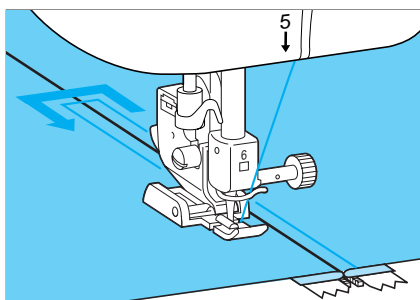

4. Topstitch 7 to 10 mm (1/4 to 3/8") from the seamed edge of the fabric, then remove the basting.

⚠ CAUTION

Make sure the needle does not strike the zipper during sewing. If the needle strikes the zipper, the needle may break, leading to injury.

Inserting a side zipper

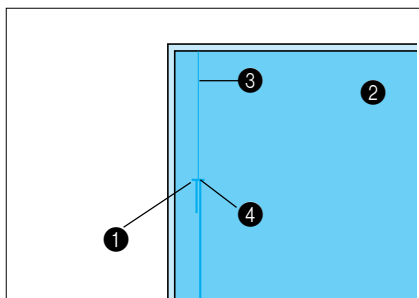

CAUTION

Make sure you sew using the middle needle position.

1. Attach presser foot "J" and sew straight stitches up to the zipper opening. Change to a basting stitch and sew to the top of the fabric.

- ❶ Reverse stitches
- ❷ Wrong side of fabric
- ❸ Basting stitches
- ❹ End of zipper opening

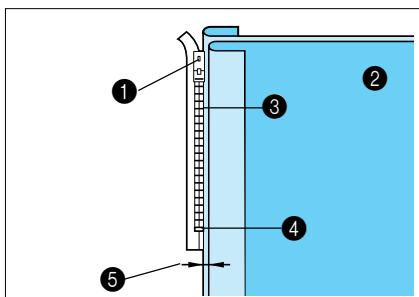

2. Press the seam allowance open and align the folded edge along the teeth of the zipper, while maintaining 3 mm (1/8") for the sewing space.

- ❶ Zipper pull tab
- ❷ Wrong side of fabric
- ❸ Zipper teeth
- ❹ End of zipper opening
- ❺ 3 mm (1/8")

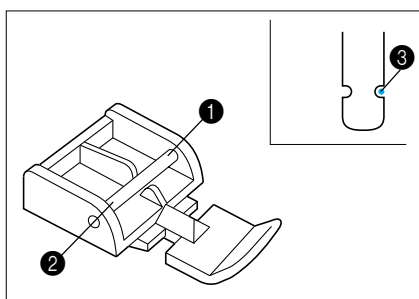

3. Remove presser foot "J". Align the right side of the pin in zipper foot "I" with the presser foot holder, and attach the presser foot.

- ❶ Right
- ❷ Left
- ❸ Needle drop position

⚠ CAUTION

When using zipper foot "I", make sure the straight stitch, middle needle position is selected. Turn the balance wheel to make sure the needle does not strike the presser foot. If another stitch is selected, the needle will strike the presser foot, causing the needle to break and possible leading to injury.

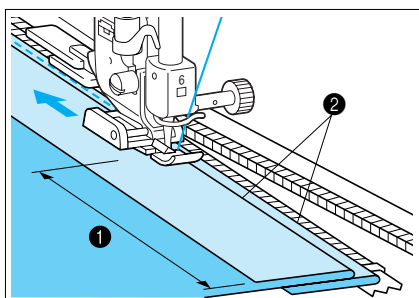

4. Set the presser foot in the 3 mm (1/8") margin. Starting from the end of the zipper opening. Sew to a point about 50 mm (2") from the edge of the fabric, then stop the machine. Pull down the zipper slider, then continue sewing to the edge of the fabric.

- ❶ 50 mm (2")
- ❷ 3 mm (1/8")

⚠ CAUTION

Make sure the needle does not strike the zipper during sewing. If the needle strikes the zipper, the needle may break, leading to injury.

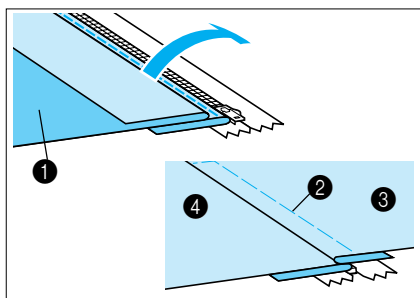

5. Close the zipper, turn the fabric over, and sew a basting stitch.

- ❶ Front of the skirt (wrong side of fabric)
- ❷ Basting stitches
- ❸ Front of the skirt (right side of fabric)
- ❹ Back of the skirt (right side of fabric)

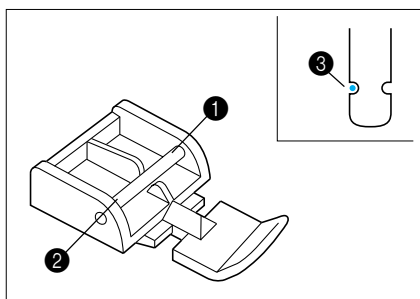

6. Remove the presser foot, and reattach it so that the left side of the pin is attached to the presser foot holder.

- ❶ Right
- ❷ Left
- ❸ Needle drop position

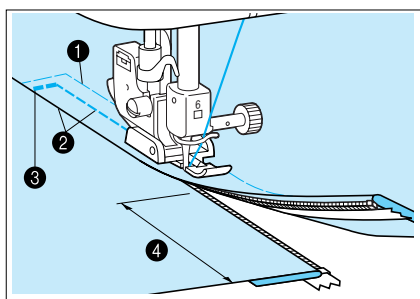

7. Set the fabric so that the left edge of the presser foot touches the edge of the zipper teeth. Sew reverse stitches at the top of the zipper, then continue sewing. Stop sewing about 50 mm (2") from the edge of the fabric, leave the needle in the fabric, and remove the basting stitches. Open the zipper and sew the rest of the seam.

- ❶ Basting stitches
- ❷ 7 to 10 mm (1/4" to 3/8")
- ❸ Reverse stitches
- ❹ 50 mm (2")



1
0

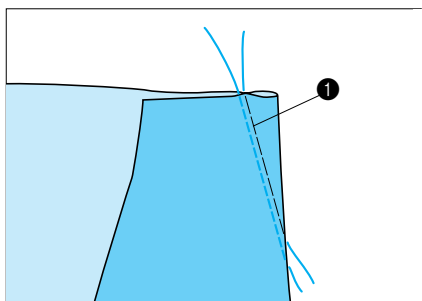

1. Attach presser foot "J", then sew a reverse stitch at the beginning of the dart and sew from the wide end to the narrow end without stretching the fabric.

1 Basting

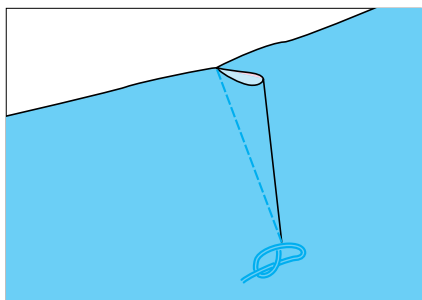

2. Do not sew a reinforcement stitch at the end. Cut the thread at the end leaving an excess 50 mm (2"), and then tie both ends together.

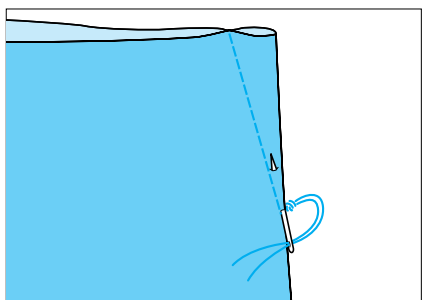

3. Insert the ends of the thread into the dart using a needle.

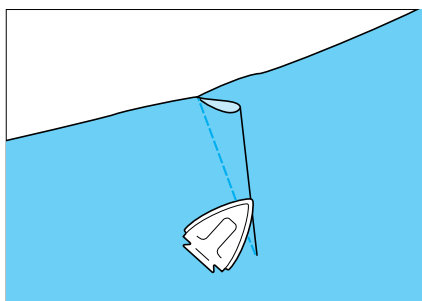

4. Iron the dart to one side so that it is flat.



1
0

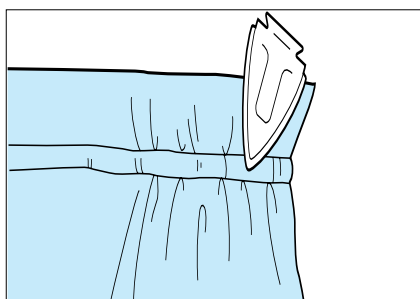
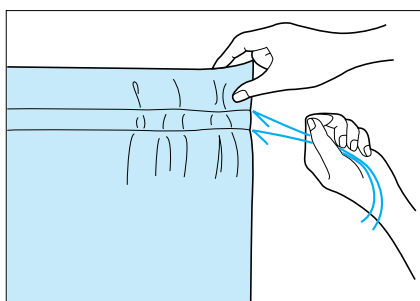
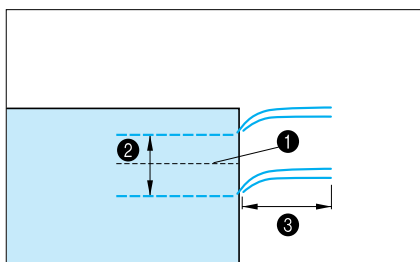
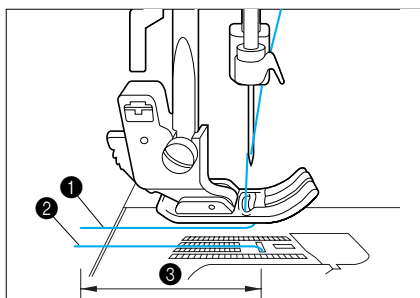
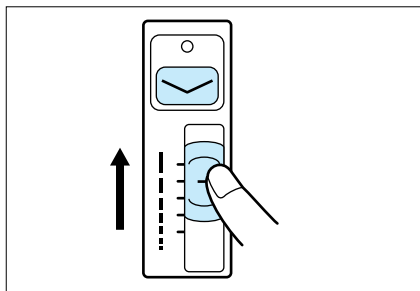

For the waists of skirts, the sleeve openings of shirts, etc.

1. Press the stitch length manual change key to turn on the LED lamp.
2. Move the stitch length adjustment lever up to increase the stitch length (about 4 mm (1/16")) as shown left figure, and select a weak thread tension.

3. Attach presser foot "J", then pull out about 50 mm (2") of both the bobbin and upper threads.

- ① Upper thread
- ② Bobbin thread
- ③ About 50 mm (2")

4. Sew two rows of straight stitches parallel to the seam line, then trim off the excess thread leaving 50 mm (2") .

- ① Seam line
- ② 10 to 15 mm (3/8" to 9/16")
- ③ About 50 mm (2")

5. Pull the bobbin threads to obtain the desired amount of gather, then tie the threads to secure them.

6. Smooth the gathers by ironing them.

Pulling up the bobbin thread

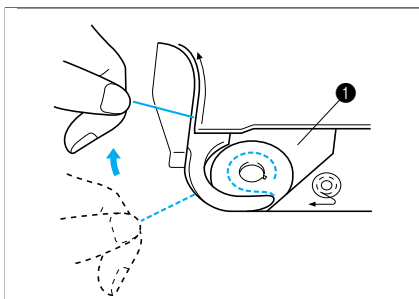

1. Pass the thread along the groove in the direction of the arrow, and leave it there without cutting it.

① Shuttle

* The bobbin cover should still be removed.

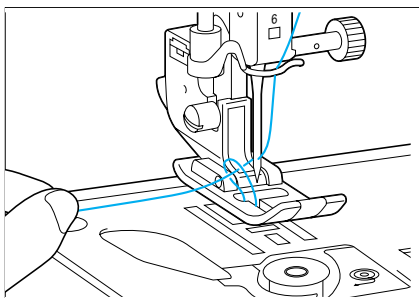

2. While holding the upper thread, press the "NEEDLE POSITION" button twice, and then pull out the bobbin thread.
3. Replace the bobbin cover.



2
- - -

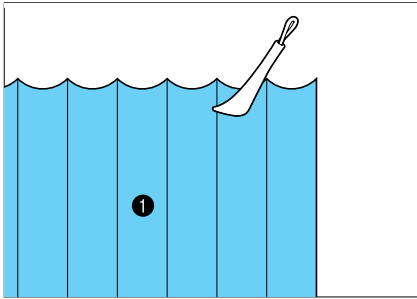

For decorating blouses, etc.

1. Mark along the folds on the wrong side of the fabric.

❶ Wrong side of fabric

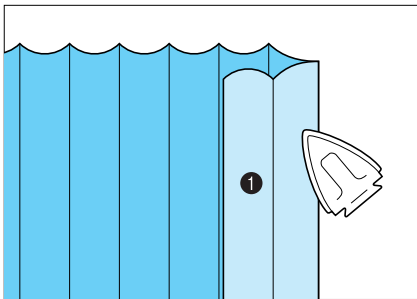

2. Fold the fabric so that the right side faces upward and iron only the folded parts.

❶ Right side of fabric

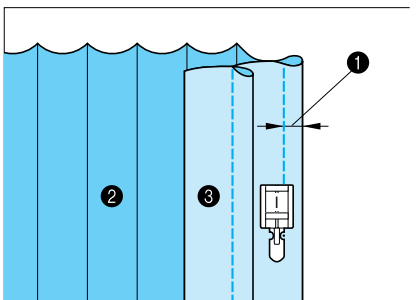

3. Attach the right pin of presser foot "I" to the holder, and sew a straight stitch along each fold.

- ❶ Width for pintuck
- ❷ Wrong side of fabric
- ❸ Right side of fabric

⚠ CAUTION

When using zipper foot "I", make sure the straight stitch, middle needle position is selected. Turn the balance wheel to make sure the needle does not strike the presser foot. If another stitch is selected, the needle will strike the presser foot, causing the needle to break and possible leading to injury.

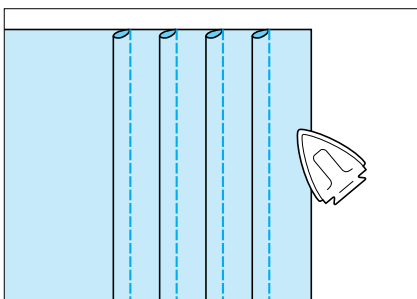

4. Iron all folds in the same direction.



2

0

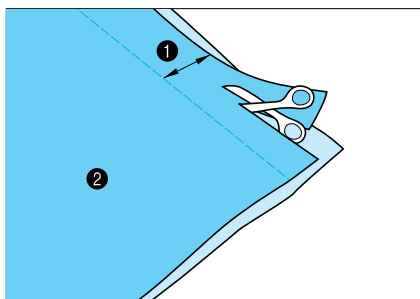

For reinforcing seams and neatly finishing edges

1. Attach presser foot "J". Sew the seam line, then cut half of the seam allowance from the side that the flat fell seam will lie against.

- ❶ About 12 mm (1/2")
- ❷ Wrong side of fabric

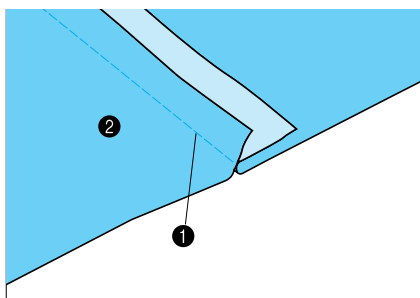

2. Spread out the fabric along the finish line.

- ❶ Finish line
- ❷ Wrong side of fabric

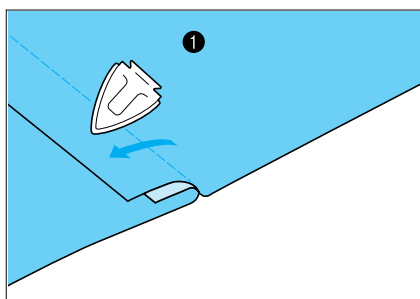

3. Lay both seam allowances to the shorter one's (cut one) side and iron them.

- ❶ Wrong side of fabric

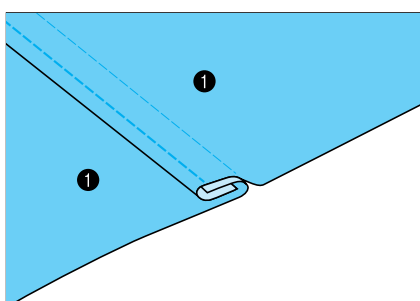

4. Fold the longer seam allowance around the shorter one, and sew the edge of the fold.

- ❶ Wrong side of fabric

* Flat-fell seam can be on the inside or outside. For example for denim jeans, jackets, etc., seam is on the outside, rather than inside as shown above.

Finished flat fell seam

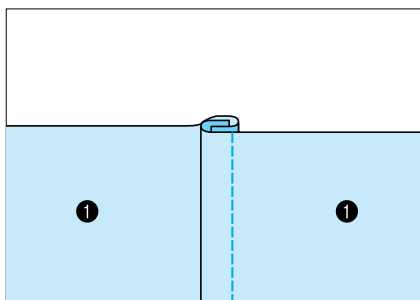

① Right side of fabric

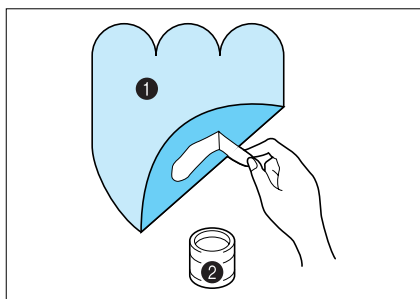
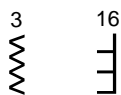

1. Use a temporary spray adhesive, fabric glue or a basting stitch to attach the appliqué to the fabric. This will keep the fabric from moving during sewing.

- ① Appliqué
- ② Fabric glue

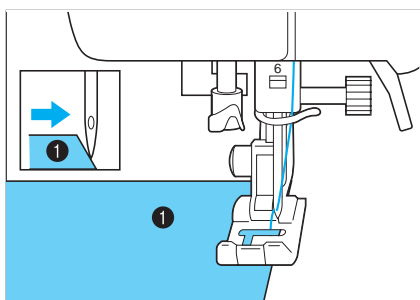

2. Attach presser foot “J”. Check that the needle drops slightly off the edge of the appliqué, then begin sewing.

- ① Appliqué material

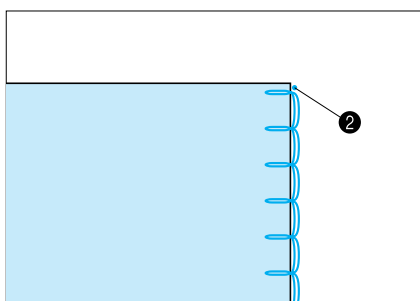

- ② Needle drop position

Sewing sharp curves

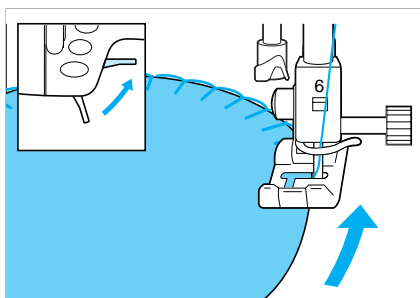

Stop the machine with the needle in the fabric outside the appliqué. Raise the presser foot and turn the fabric a little bit at a time while sewing, for an attractive finish to the seam.

* Placing a lightweight tear away stabilizer beneath stitching area will improve the stitch placement along the edge of the appliqué fabric.

SCALLOP STITCH



19

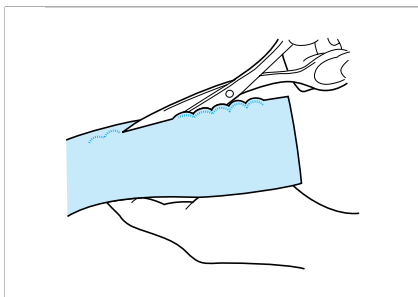
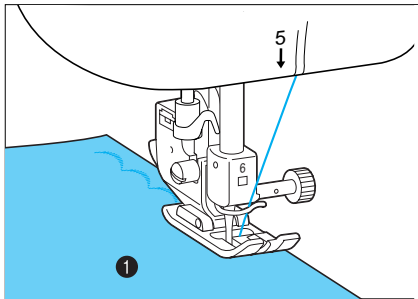

For decorating the collars of blouses, the edges of tablecloths, etc.

1. Attach presser foot "N", then sew the edge of the fabric so that the stitches are not right on the edge of the fabric.

1 Right side of fabric

2. Trim along the stitches carefully so as not to cut the stitches.

* There are products in the marketplace that will "seal" the trimmed areas. This will give a more finished appearance.



17



18

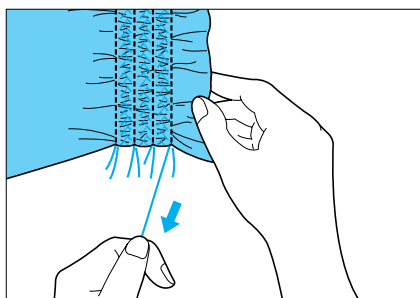
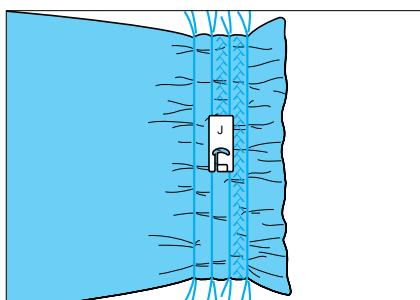
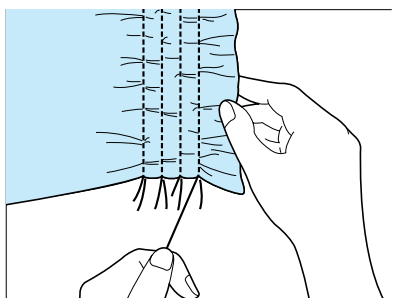
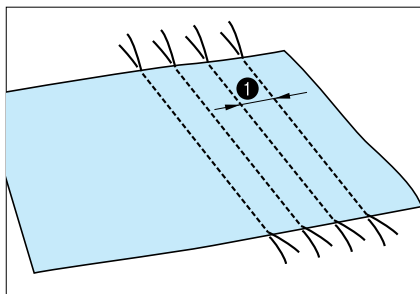
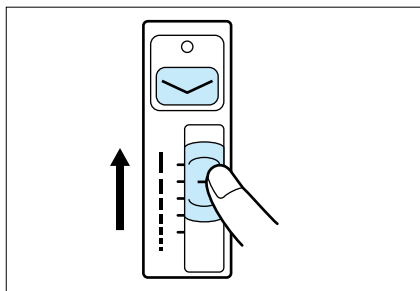

For making decorative stitching

1. Select “” press the stitch length manual change key to turn on the LED lamp. Move the stitch length adjustment lever up to increase the stitch length (about 4 mm (3/16”)) as shown left figure, and select a weak thread tension.
2. Sew the seams, leaving about 10 mm (3/8”) between the seams.
 - ① About 10 mm (3/8”)
3. Pull the bobbin threads to obtain the desired amount of gather, and then smooth the gathers by ironing them.
4. Attach presser foot “J” and select the decorative smocking stitch to sew the spaces between the straight seams.
5. Pull out the straight stitch threads.



17



18



For fagoting, decorating, etc.

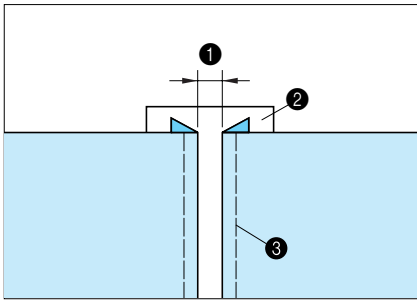

1. Baste two pieces of fabric onto thin paper, leaving a space of 4 mm (3/16") between the fabrics.

- ① 4 mm (3/16")
- ② Paper
- ③ Basting stitches

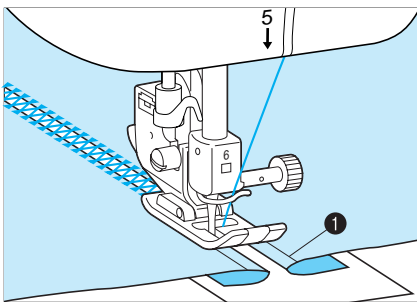

2. Attach presser foot "J". Align the center of the presser foot with the middle of the space between the fabrics and begin sewing. Use a thick thread.

- ① Basting stitches

3. When sewing is finished, gently tear the paper away.

DECORATIVE STITCHING

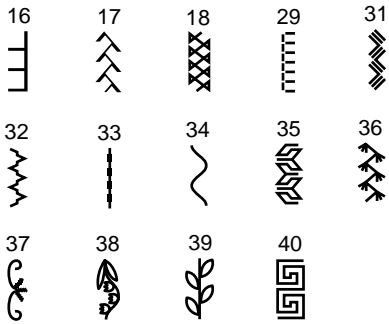

Decorative stitching

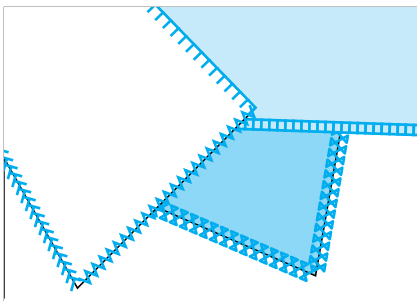

These stitches are used as decorative hem stitches or to decorate the seams of crazy quilts. Use a contrasting thread color or decorative embroidery thread.

Changing the size of a decorative stitch

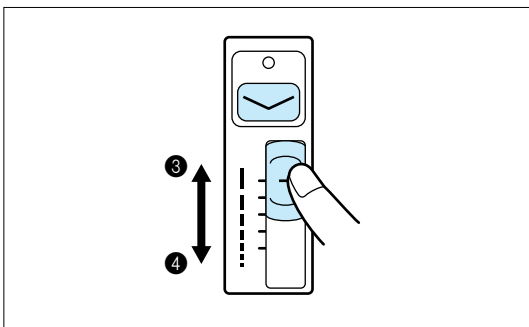
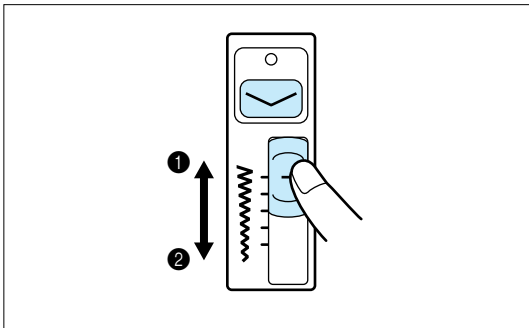

Use the stitch width or stitch length keys to adjust the zigzag stitch width and the stitch length.

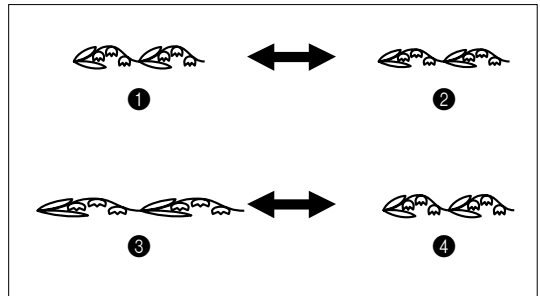

* Depending on the types of fabric and pattern used, the thread may become tangled if the pattern is very detailed.

HEMSTITCH (HEIRLOOM STITCH)

27



28



29



30





For sewing tablecloths, decorative hems on clothes and decorative stitching on shirtfronts.

A more attractive finish can be obtained if you use the “130/705H Wing” needle when sewing these patterns.

If using a wing needle and the stitch width has been set to manual, check that the needle will not touch the presser foot before starting sewing.

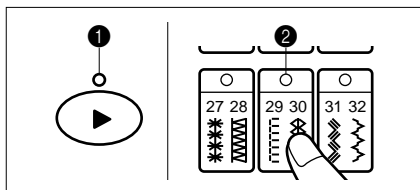
Hemstitching 1



1. Press the  key to turn on the LED lamp and select the stitch for hemstitch.

* Check that the stitch pattern switch key's LED lamp is not lit. If the LED lamp is lit, press the stitch pattern switch key to turn off the lamp.

① Lamp is turned off

② Lamp is lit

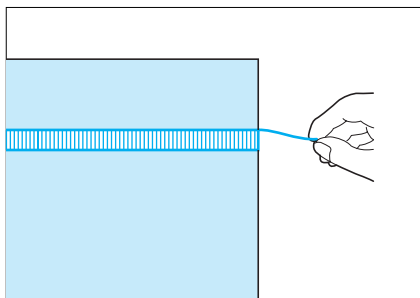

2. Pull out several threads from one area on a piece of fabric to open the area. Pull out 5 or 6 threads to leave a 3 mm (1/8") area open.

* Loosely woven fabrics work best for this.

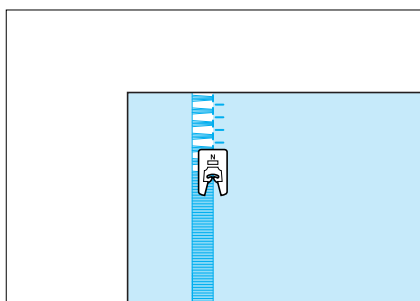

3. Attach presser foot “N”. With the right side of the fabric facing up, sew one edge of the open area.

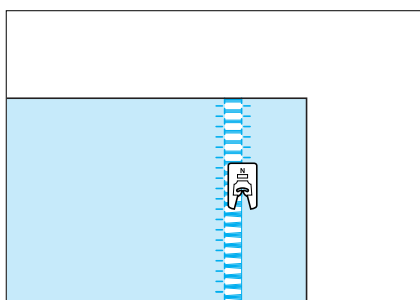

4. With the right side of the fabric continuing to face you, turn the fabric and sew the other edge of the frayed part, aligning the stitches so they are parallel.

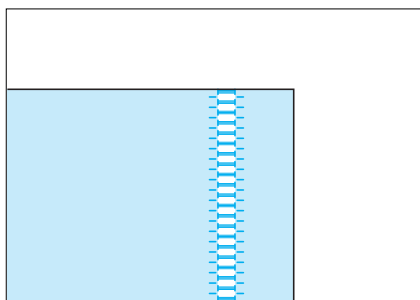

5. Illustration of finished product.

Hemstitching 2

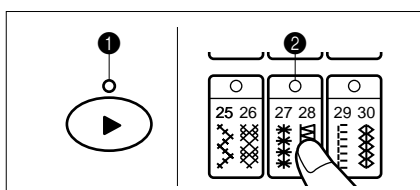

1. Press the ²⁷ ²⁸ key to turn on the LED lamp, and press the stitch pattern switch key to select the stitch for hemstitching.
* Check that the stitch pattern switch key's LED lamp is lit.

- ① Lamp is lit
- ② Lamp is lit

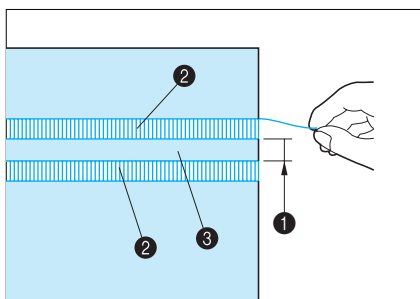

2. Pull out several threads from both sides of the 4 mm (3/16") area which is not yet open. (Pull out four threads, leave five threads and then pull out four threads, the width of five threads is approximately 4 mm (3/16") or less.)

- ① Approx. 4 mm (3/16") or less
- ② Four threads (pull out)
- ③ Five threads (leave)

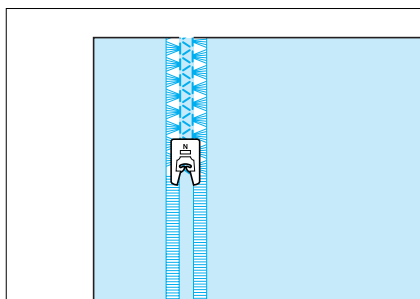

3. Sew the decorative stitch on the center of the five threads created above.

* Using a wing needle is an option.

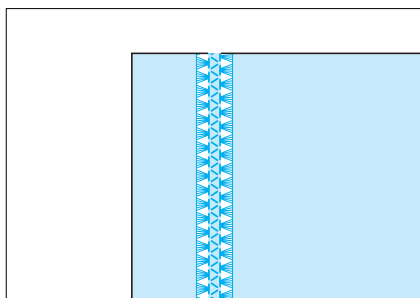

4. Illustration of finished product.



2

3
~ ~ ~
~ ~ ~

19
~ ~ ~
~ ~ ~

Decorative stitches where the zigzag width can be changed manually..

⚠ CAUTION

- Use only twin needles made for this machine (part code X59296-001). Other needles could break, resulting in damage.
- Do not sew with bent needles. The needle could break and cause injury.
- When using the twin needle, use the presser foot “J” regardless of what kind of sewing will be carried out.

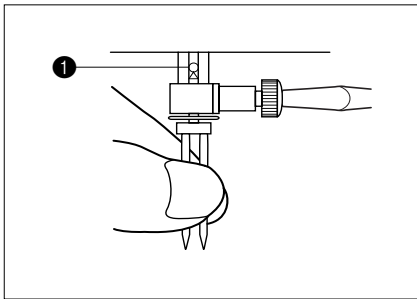

1. Turn the main power switch to OFF, and install the twin needle (see page 25 “Changing the Needle”).

① Stopper

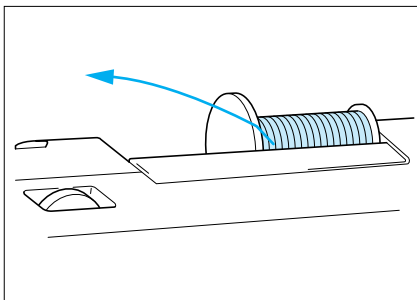

2. Do the upper threading. Follow the steps for threading a single needle for the first threading (see page 13 “Upper Threading”).

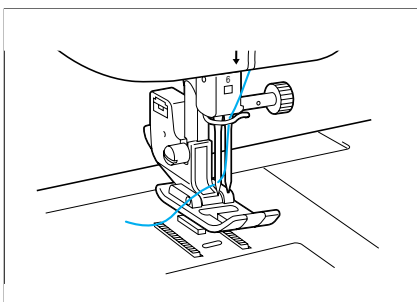

3. Pass the thread through the needle clamp thread guide on the needle bar, then thread the needle on the left side.

Caution

The needle threader lever can not be used. Thread the twin needle by hand, from front to back. Using the needle threader lever may result in damage to the machine.

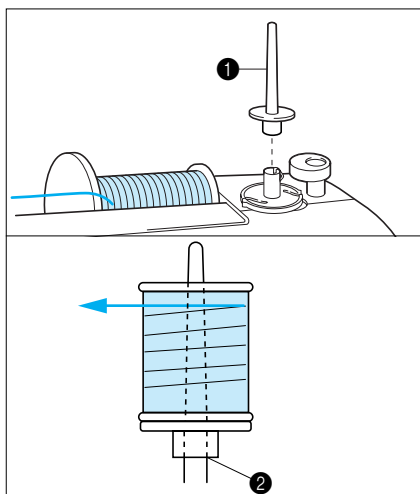

4. Set the extra spool pin into the hole on the end of the bobbin winder shaft on the top of the machine. Follow the instructions for single-needle threading.

- ① Extra spool pin for right needle threading.
- ② Push the spool pin securely into place.

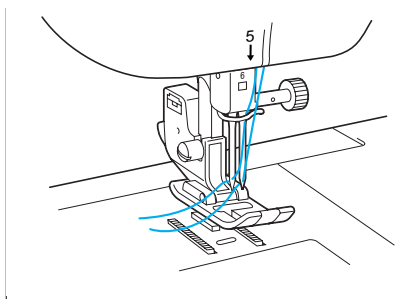

5. Do not set the thread in the needle clamp thread guide on the needle bar. Thread the needle on the right side.

Caution

The needle threader can not be used. Thread the twin needle by hand, from front to back. Using the needle threader may result in damage to the machine.

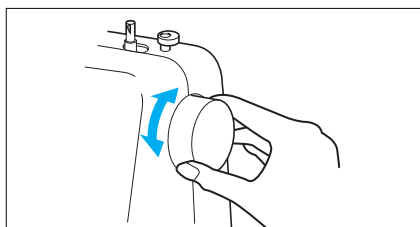

⚠ CAUTION

Stitch width

Adjust the stitch width. Turn the balance wheel to check the needle does not touch the needle plate. If the needle hit the needle plate the needle may break and cause injury.

Stitch length

- Straight 2 mm min.
- Others 0.5 mm min.

Types of thread

Cotton thread or spun thread are recommended because synthetic threads may break.

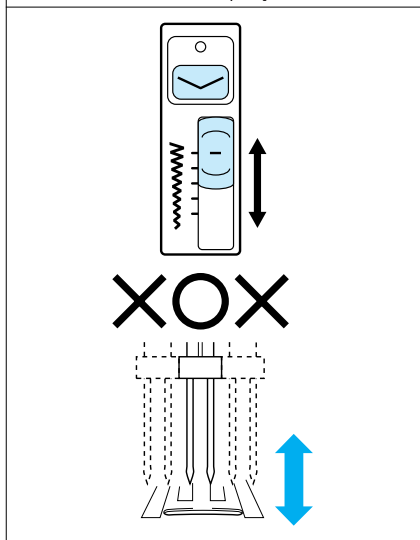

SEWING

Sewing attractive finishes

Refer to the table below and the “FABRIC/THREAD/NEEDLE COMBINATION CHART” for recommended fabrics, threads and needles to use in order to obtain attractive sewing finishes. Furthermore, pattern slippages may occur when using different fabric thicknesses or types of stabilizers. Be sure to carry out a test sewing beforehand to check.

FABRIC	When sewing lightweight or stretch fabrics, fabrics with coarse weaves, or decorative stitches stored in the machine; attach interfacing to the wrong side. If you do not wish to attach interfacing, place the fabric onto some thin paper such as tracing paper before starting to sew. This acts as a stabilizer.
THREAD	#50 – #60
NEEDLE	Lightweight and medium fabrics 75/11 Heavyweight fabrics 90/14 Stretch fabrics #14 Ball point needle (golden colored)

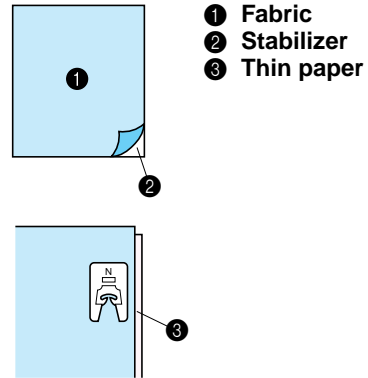

MAINTENANCE

CLEANING THE MACHINE

⚠ CAUTION

Be sure to unplug the machine before cleaning it. Otherwise, electric shock or injury may result.

Cleaning the operation panel

If the operation panel is dirty, gently wipe it with a soft, dry cloth. Do not use organic solvents or detergents.

Cleaning the machine casing

If the surface of the machine is dirty, lightly soak a cloth in a neutral detergent, squeeze it out firmly and then wipe the surface. Then wipe again with a dry cloth.

Cleaning the race and shuttle

If dust or bits of dirt collect in the race or shuttle, the machine will not run well. Keep the machine clean for best results.

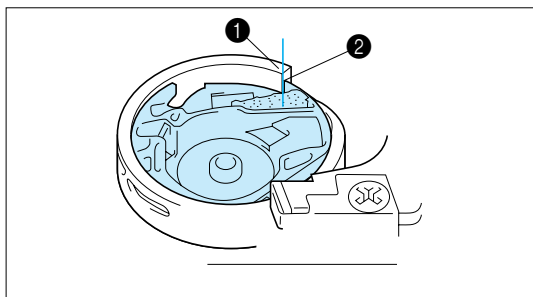
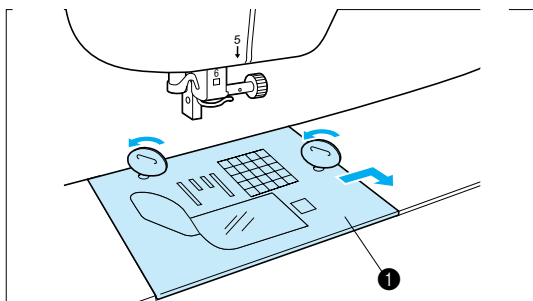
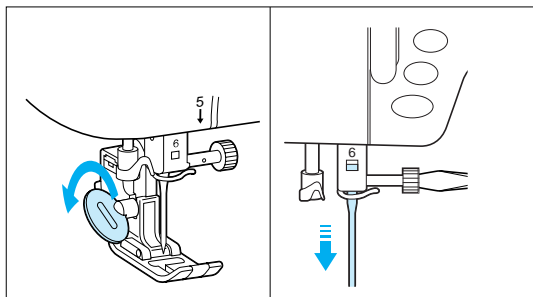

1. Turn off the power. Remove the presser foot holder and the needle.

2. Loosen the screws with the disc-shaped screwdriver and remove the needle plate.

① Needle plate

3. Turn the balance wheel, and align the notch of shuttle a little to the left of the shelf of race, as shown.

CAUTION

Be sure to turn the balance wheel towards the front of the machine. Turning the balance wheel in the other direction may damage the machine.

- ① Notch of shuttle
- ② Shelf of race

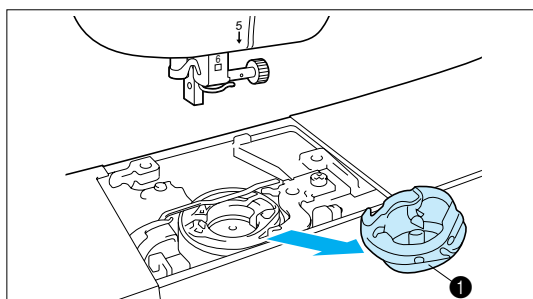

4. Remove the race.
* While pushing the race towards the back of the machine, lift the edge nearest you and remove the race.

① Race

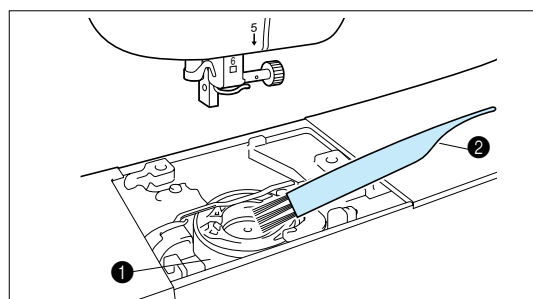

5. Remove accumulated lint and thread from the inner shuttle and race with a brush or vacuum cleaner.
* Do not oil the shuttle or the race.

① Shuttle
② Brush

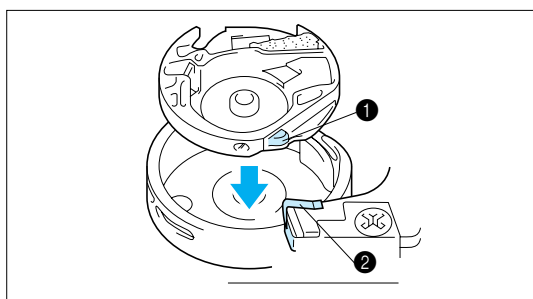

6. Check that the notch on the shuttle is in the same position as when you removed the race. Position the race so that the shelf and spring are aligned, and insert the race.

⚠ CAUTION

- Do not use a damaged race or shuttle. Otherwise, the thread may tangle and cause a poor finish, or the needle may break. You can get the proper parts from your authorized dealer.
- Be sure to insert the race in the correct position. Otherwise, the needle may break.

① Shelf
② Spring

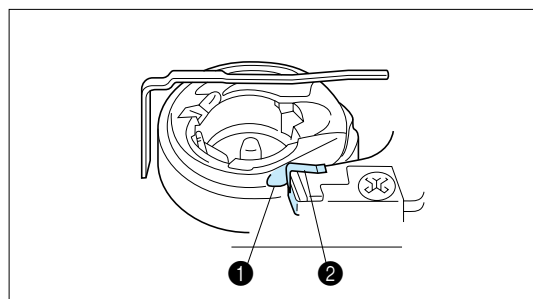

7. Reattach the needle plate.

CHANGING THE LIGHT BULB

⚠ CAUTION

- Turn off the main power switch and unplug the machine before changing the light bulb. If the machine is on and the “Start/Stop” button is pressed accidentally, injuries may result.
- To avoid burns, give the light bulb time to cool before changing it.

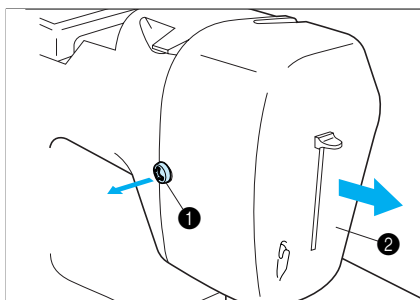

1. Turn off the main power switch.
2. Use a screwdriver to loosen the screw on the back of machine light cover. Then remove the light cover.

- 1 Screw
- 2 Light cover

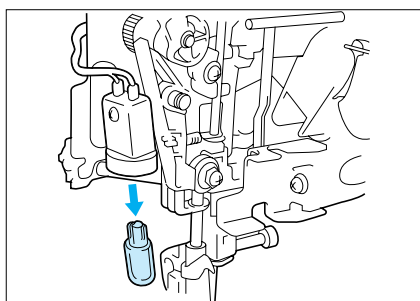

3. Remove the light bulb as shown, and align the projection on the light bulb with the notch in the socket. Replace it with a new light bulb.

CAUTION

Use only light bulbs intended for use with this machine (12V/ 5W: part no. XA2037001). You can get the proper light bulb at your authorized dealer.

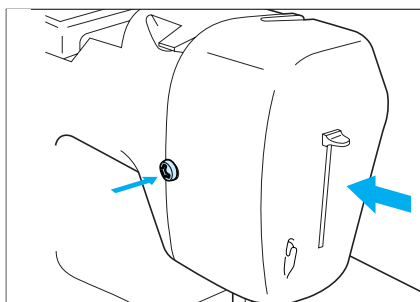

4. Replace light cover and tighten the screw on the back of the machine.

TROUBLE SHOOTING

Trouble with threads and stitches

Before calling for service, check the following items. If the problem still persists, contact your nearest authorized Brother dealer.

Symptom	Probable cause	Remedy
1. Upper thread breaks	1. Upper threading is not correct.	1. Re-thread upper thread.
	2. Upper thread is entangled.	2. Remove thread ends in the race or shuttle.
	3. Spool of thread is not correctly set.	3. Set spool of thread correctly.
	4. Correct needle is not used.	4. Change to proper needle.
	5. Shuttle is damaged.	5. Contact service center.
2. Bobbin thread breaks	1. Upper thread is entangled.	1. Remove thread ends in the race or inner shuttle.
	2. Bobbin is not threaded properly in the shuttle.	2. Set bobbin properly and pull out the bobbin thread.
3. Skipped stitches	1. Needle is not correctly inserted.	1. Insert needle properly.
	2. Correct needle is not used.	2. Change to proper needle.
	3. The combination of fabric, thread and needle is not correct.	3. Check the "FABRIC/THREAD/NEEDLE COMBINATION CHART" on page 26.
	4. Dust is clinging under the needle plate.	4. Remove dust by cleaning with a brush.
	5. Upper threading is not correct.	5. Re-thread upper thread.
4. Fabric puckers	1. Threading is not correct.	1. Re-thread upper and bobbin thread correctly.
	2. Correct needle is not used.	2. Change to proper needle.
	3. Combination of fabric, thread and needle is not correct.	3. Check the "FABRIC/THREAD/NEEDLE COMBINATION CHART" on page 26.
	4. Thread tension is not correct.	4. Refer to "THREAD TENSION" on page 20.
5. Inability to thread needle	1. Needle position is not correct.	1. Set needle at proper position using "NEEDLE POSITION" button.
	2. Hook of needle threader does not fit into the eye of the needle.	2. Set needle at proper position using "NEEDLE POSITION" button.
6. Thread tension is incorrect	1. Upper threading is not correct.	1. Re-thread upper thread.
	2. Set of bobbin thread is not correct.	2. Set bobbin properly and pull out the bobbin thread.
	3. Combination of fabric, thread and needle is not correct.	3. Check the "FABRIC/THREAD/NEEDLE COMBINATION CHART" on page 26.
	4. Presser foot holder is not correctly installed.	4. Install the foot holder correctly.

Mechanical trouble

Symptom	Probable cause	Remedy
1. Fabric is not fed properly	1. Feed dog is lowered.	1. Raise the feed dog with the feed dog position switch.
	2. Stitch length is set at no feeding.	2. Set stitch length properly.
	3. The combination of selected stitch and presser foot is not correct.	3. Change presser foot to correct one.
	4. Correct needle is not being used.	4. Change to proper needle.
	5. Thread is entangled.	5. Remove thread-ends in the race or inner shuttle.
2. Needle breaks	1. Needle is not correctly inserted.	1. Set needle properly.
	2. Correct needle is not used.	2. Change to proper needle.
	3. The combination of fabric, thread and needle is not correct.	3. Check the "FABRIC/THREAD/NEEDLE COMBINATION CHART" on page 26.
	4. The fabric is pulled too much.	4. Guide the fabric allowing it to sew without pulling.
3. Machine does not start	1. "START/STOP" button is not pressed.	1. Press "START/STOP" button.
	2. Main power switch is in the off position.	2. Turn the power on.
	3. Presser foot is not lowered.	3. Lower the presser foot.

Note

- If the power goes out while the sewing machine is being operated:
Turn off the sewing machine and unplug its power cord.
When the sewing machine is restarted, operate it correctly according to the operating procedure.

Alarm

- When operating correctly : 1 beep
- When operating incorrectly : 2 beeps or 4 beeps

SEWING CHART

CATEGORY	NAME OF PATTERN	PATTERN	TYPE OF PRESSER FOOT	USE	REINFORCEMENT STITCHING	STITCH ADJUSTMENT BY STITCH WIDTH KEYS	STITCH ADJUSTMENT BY STITCH LENGTH KEYS	TWIN NEEDLE POSSIBILITY
UTILITY STITCH	STRAIGHT STITCH (LEFT)			General sewing, gathering, pintuck, etc.	R	★	★	NO
	STRAIGHT STITCH (MIDDLE)				R	—	★	OK (J)
	ZIGZAG STITCH				R	★	★	OK (J)
	3 STEP ELASTIC ZIGZAG				△	★	★	NO
	TRIPLE STRETCH STITCH				△	★	★	NO
	OVERCASTING STITCH					△	★	★
				△	★	★	NO	
				△	★	★	NO	
	BLIND HEM STITCH			Hemming woven fabrics	△	★	★	NO
	BLIND HEM STITCH STRETCH			Hemming stretch fabrics	△	★	★	NO
	ROUNDED BUTTONHOLE			Buttonholes for blouses and shirts		★	★	NO
	SQUARED BUTTONHOLE			Buttonholes for pajamas and shirts		★	★	NO
	STRETCH BUTTONHOLE			Buttonholes for stretch fabric		★	★	NO
	HEIRLOOM BUTTONHOLE			Buttonholes for stretch		★	★	NO
	KEYHOLE BUTTONHOLE			Buttonholes for suits and overalls		★	★	NO
	BLANKET STITCH			Appliqués	△	★	★	NO
	FEATHER STITCH			Smocking, decorative stitching	△	★	★	NO
	FAGOTING CROSS STITCH			Fagoting, decorative stitching	△	★	★	NO

CONTENTS

BEFORE USE

























SEWING





UTILITY STITCHES

MAINTENANCE

SEWING CHART

PATTERNS (PROGRAMMED IN MACHINE)

CATEGORY	NAME OF PATTERN	PATTERN	TYPE OF PRESSER FOOT	USE	REINFORCEMENT STITCHING	STITCH ADJUSTMENT BY STITCH WIDTH KEYS	STITCH ADJUSTMENT BY STITCH LENGTH KEYS	TWIN NEEDLE POSSIBILITY			
UTILITY STITCH	SCALLOP STITCH	19 		Decorating collar of blouse, edge of handkerchief	△	★	★	OK (J)			
	EYELET	20 		For making eyelet on belt, etc		★	★	NO			
DECORATIVE STITCH	SATIN STITCH	21 			For decoration, etc.	△	★	★	NO		
		22 				△	★	★	NO		
		23 				△	★	★	NO		
		24 				△	★	★	NO		
	CROSS STITCH	25 					For decoration etc.	△	★	★	NO
		26 						△	★	★	NO
HEIRLOOM	HEMSTITCHING	27 			Decorative and heirloom stitching	△	★	★	NO		
		28 				△	★	★	NO		
		29 	△			★	★	NO			
		30 	△			★	★	NO			
DECORATIVE STITCH	DECORATIVE STITCH	31 		Decorative topstitching	△	★	★	NO			
		32 		For decoration, etc.	△	★	★	NO			
	DECORATIVE STITCH		33 	For decoration, etc.	△	★	★	NO			
			34 		△	★	★	NO			
			35 		△	★	★	NO			
			36 		△	★	★	NO			

CATEGORY	NAME OF PATTERN	PATTERN	TYPE OF PRESSER FOOT	USE	REINFORCEMENT STITCHING	STITCH ADJUSTMENT BY STITCH WIDTH KEYS	STITCH ADJUSTMENT BY STITCH LENGTH KEYS	TWIN NEEDLE POSSIBILITY
DECORATIVE STITCH	DECORATIVE STITCH	37 		For decoration, etc.	△	★	★	NO
		38 			△	★	★	NO
		39 			△	★	★	NO
		40 			△	★	★	NO

R : The machine sews in reverse while the “REVERSE STITCH” button is pushed.

△ : The machine sews three reinforcement stitches and stops when the “REVERSE STITCH” button is pushed.

★ : Adjustments can be made.

— : Adjustments cannot be made.

CAUTION

Make sure to use the correct presser foot for each stitch pattern. Otherwise, the needle may strike the presser foot and bend or break, causing injury.

PATTERNS (PROGRAMMED IN MACHINE)

CONTENTS

BEFORE USE

SEWING

UTILITY STITCHES

MAINTENANCE

SEWING CHART

PATTERNS (PROGRAMMED IN MACHINE)

Utility stitches

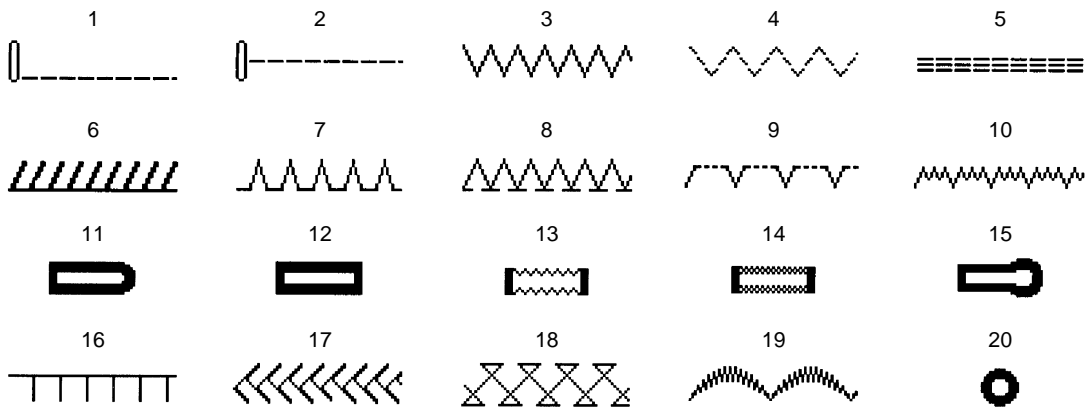

Decorative stitches

Satin stitches



Cross stitches

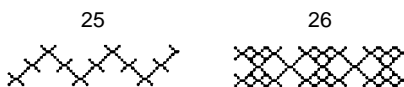

Heirloom



Decorative stitch

